

Advanced Variable Air Volume System Design Guide



DESIGN GUIDELINES

October 2003
P500-03-082-A-11



Gray Davis, *Governor*

CALIFORNIA ENERGY COMMISSION

Prepared By:
Taylor Engineering
Mark Hydeman
Steve Taylor
Jeff Stein

Eley Associates
Erik Kolderup
Tianzhen Hong

Managed By:
New Buildings Institute
Cathy Higgins,
Program Director
White Salmon, WA
CEC Contract No. 400-99-013

Prepared For:
Donald Aumann,
Contract Manager

Nancy Jenkins,
PIER Buildings Program Manager

Terry Surles,
PIER Program Director

Robert L. Therkelsen
Executive Director

DISCLAIMER

This report was prepared as the result of work sponsored by the California Energy Commission. It does not necessarily represent the views of the Energy Commission, its employees or the State of California. The Energy Commission, the State of California, its employees, contractors and subcontractors make no warrant, express or implied, and assume no legal liability for the information in this report; nor does any party represent that the uses of this information will not infringe upon privately owned rights. This report has not been approved or disapproved by the California Energy Commission nor has the California Energy Commission passed upon the accuracy or adequacy of the information in this report.

Acknowledgements

Project Director: Erik Kolderup, Eley Associates.

Principal Investigator: Mark Hydeman, Taylor Engineering.

Research Team: Steve Taylor and Jeff Stein, Taylor Engineering; Tianzhen Hong and John Arent, Eley Associates.

Editing and Document Production: Kimberly Got, Zelaikha Akram, and Debra Janis, Eley Associates.

Review and Advisory Committee: Karl Brown, CIEE; David Claridge, Texas A&M; Paul Dupont, Dupont Engineering; Ken Gillespie, Pacific Gas & Electric; Tom Hartman, the Hartman Company; Henry Lau, Southern California Edison; and David Sellers, PECL, Inc.

Project Management: Cathy Higgins, Program Director for the New Buildings Institute and Don Aumann, Contract Manager for the California Energy Commission. Additional review was provided by Alan Cowan and Jeff Johnson, New Buildings Institute.

Preface

The Advanced Variable Air Volume (VAV) System Design Guide (Design Guide) provides a powerful new resource for Heating, Ventilation, and Air-Conditioning (HVAC) designers. It presents brand new information on fan selection and modeling and provides the most current recommendations on VAV airside system design.

...a powerful new resource for heating, ventilation, and air conditioning designers.

Total large office building energy savings of up to 12% are achievable by applying the recommendations in the Design Guide resulting in an estimated annual statewide savings of 2,220 MWh/yr for new large office construction.

The Design Guide is a product of a three-year research project that included field monitoring of five sites with built-up VAV systems. It contains measures and recommendations from a range of sources including our research, associated research¹, ASHRAE Guidelines and Standards, Title 24, team experience gained in the design and commissioning of mechanical systems and controls for commercial buildings and in performing peer reviews of mechanical designs of commercial buildings. Throughout this document we refer to standard practice. This is a subjective benchmark that is determined based on our experience as mechanical engineers, reviewing the work of other firms, and through our conversations with manufacturers and contractors.

The Advanced VAV System Design Guide was developed as part of the *Integrated Energy Systems — Productivity and Building Science* project, a Public Interest Energy Research (PIER) program administered by the California Energy Commission under contract No. 400-99-013, and managed by the New Buildings Institute.

The Buildings Program Area within the PIER Program produced this Design Guide. The program includes new and existing buildings in both the residential and the non-residential sectors. It seeks to decrease building energy use through research that will develop or improve energy efficient technologies, strategies, tools, and building performance evaluation methods.

This document is part of report #P500-03-082 (Attachment A-11 Product 3.6.2). For other reports produced within this contract or to obtain more information on the PIER Program, please see Project Reports in Appendix 7, visit www.energy.ca.gov/pier/buildings or contact the Commission's Publications Unit at 916-654-5200. The Design Guide is also available at www.newbuildings.org

¹ PIER, ASHRAE, CBE and others

Abstract

The Advanced Variable Air Volume (VAV) System Design Guide (Design Guide) is written for Heating, Ventilation, and Air-Conditioning (HVAC) designers and focuses on built-up VAV systems in multi-story commercial office buildings in California.

The Design Guide recommendations include best practices for airside system design, covering fans, air handlers, ducts, terminal units, diffusers, and controls, with emphasis on getting the air distribution system components to work together in an integrated fashion. Key topics critical to optimal VAV design and performance are addressed in the following chapters: 1) early design issues, 2) zone issues, 3) VAV box selection, 4) duct design, 5) supply air temperature reset, 5) fan type, size and control, 6) coils and filters, and 7) outdoor air, return air and exhaust air. The intent of the information is to promote efficient, practical designs that advance standard practice, achieve cost effective energy savings and can be implemented using current technology.

Author: Mark Hydeman, Steve Taylor, Jeff Stein, Taylor Engineering. Erik Kolderup, Eley Associates

Keywords: Variable Air Volume, VAV, HVAC, Fans, Ducts, Commercial Building, Distribution System, Energy Savings

TABLE OF CONTENTS

ACKNOWLEDGEMENTS	I
PREFACE	II
ABSTRACT	III
OVERVIEW	1
AUDIENCE & OBJECTIVES	1
KEY RECOMMENDATIONS	1
ENERGY IMPACTS	4
DESIGN GUIDE ORGANIZATION	5
INTRODUCTION	9
OBJECTIVE	9
ROLE OF THE DESIGNER	10
MARKET SHARE	10
EARLY DESIGN ISSUES	13
INTEGRATED DESIGN ISSUES	13
THE ROLE OF SIMULATION IN DESIGN	15
HVAC SYSTEM SELECTION	21
LOCATION AND SIZE OF AIRSHAFTS	27
RETURN AIR SYSTEM	29
AUXILIARY LOADS	31
DESIGN AIRSIDE SUPPLY TEMPERATURE	32
CODE VENTILATION REQUIREMENTS	34
DETERMINING INTERNAL LOADS	35
SIMULATION AND PERFORMANCE TARGETS	46
ZONE ISSUES	49
THERMAL COMFORT	49
ZONING AND THERMOSTATS	50
DEMAND CONTROL VENTILATION (DCV)	51
OCCUPANCY CONTROLS	54
WINDOW SWITCHES	54
DESIGN OF CONFERENCE ROOMS	55
VAV BOX SELECTION	57
VAV BOX SELECTION SUMMARY	57
VAV REHEAT BOX CONTROL	58
MINIMUM AIRFLOW SETPOINTS	61
SIZING VAV REHEAT BOXES	68
OTHER BOX TYPES	73
OTHER ISSUES	79
DUCT DESIGN	83
GENERAL GUIDELINES	83
SUPPLY DUCT SIZING	88
RETURN AIR SYSTEM SIZING	92
FAN OUTLET CONDITIONS	93

NOISE CONTROL.....	95
SUPPLY AIR TEMPERATURE CONTROL	99
OPTIMAL SUPPLY AIR TEMPERATURE.....	99
RECOMMENDED SEQUENCE OF OPERATION	101
SYSTEM DESIGN ISSUES	102
CODE REQUIREMENTS.....	103
FAN TYPE, SIZE AND CONTROL	105
FAN SELECTION CRITERIA.....	105
VISUALIZING FAN PERFORMANCE.....	110
FAN SELECTION CASE STUDIES.....	116
COMPARING MANUFACTURERS.....	136
FAN CONTROL.....	137
CONCLUSIONS.....	145
COILS AND FILTERS.....	147
CONSTRUCTION FILTERS.....	147
PRE-FILTERS	147
FINAL FILTER SELECTION.....	147
FILTER AREA.....	148
EXTENDED SURFACE AREA FILTERS	148
MONITORING FILTERS.....	148
COIL SELECTION	148
COIL BYPASS.....	150
OUTSIDE AIR/RETURN AIR/EXHAUST AIR CONTROL.....	151
CONTROL OF MINIMUM OUTDOOR AIR FOR VAV SYSTEMS.....	151
DESIGN OF AIRSIDE ECONOMIZER SYSTEMS	159
ECONOMIZER TEMPERATURE CONTROL.....	163
ECONOMIZER HIGH-LIMIT SWITCHES	164
APPENDIX 1 – MONITORING SITES.....	166
SITE 1	166
SITE 2	169
SITE 3.....	172
SITE 4.....	174
SITE 5.....	177
APPENDIX 2 – MEASURED FAN PERFORMANCE	180
ENERGY BENCHMARK DATA.....	180
APPENDIX 3 – AIRFLOW IN THE REAL WORLD.....	186
APPENDIX 4 – COOLING LOADS IN THE REAL WORLD	194
APPENDIX 5 – DOE-2 FAN CURVES.....	198
APPENDIX 6 – SIMULATION MODEL DESCRIPTION.....	200
ASSUMPTIONS	200
RESULTS.....	202
APPENDIX 7 – REFERENCES.....	208
GENERAL	208
CONTROLS.....	209

SUPPLY AIR TEMPERATURE	209
NIGHT FLUSHING	209
LOAD CALCULATIONS.....	209
VAV BOX SIZING.....	210
FANS AND FAN SYSTEMS	210
FILTERS.....	211
OUTSIDE AIR DAMPERS	211
CO ₂ AND DCV	212
PROJECT REPORTS.....	212

LIST OF FIGURES

Figure 1. San Francisco	5
Figure 2. Sacramento.....	5
Figure 3. Overview of Guideline Contents	6
Figure 4 – Commercial New Construction Breakdown Forecast by Floor Area, Total 157,000,000 ft ² /yr. Source: California Energy Commission	11
Figure 5. The Role of Simulation in Design	18
Figure 6. Measured System Airflow, Site 3.....	20
Figure 7. Measured Cooling Delivered by Air Handler, Site 3 (Light bar includes Aug-Oct 2002, dark bar covers Nov 2002 – Jan 2003)	20
Figure 8. Typical Duct Shaft with Unducted Return	28
Figure 9. Typical Duct Riser	29
Figure 10. Measured Lighting Schedules (90 th percentile for design load calculation and 50 th percentile for energy simulations) for Small, Medium and Large Office Buildings – ASHRAE 1093-RP.....	38
Figure 11. Measured Weekday Lighting Profile – Site 1 Office Area Showing Average (line) and Min/Max (dashes)	40
Figure 12. Measured Weekend Lighting Profile – Site 1 Office Area Showing Average (line) and Min/Max (dashes)	40
Figure 13. Office Equipment Load Factor Comparison – Wilkins, C.K. and N. McGaffin. ASHRAE Journal 1994 - Measuring computer equipment loads in office buildings	41
Figure 14. Measured Equipment Schedules (90 th percentile for design load calculations and 50 th percentile for energy simulations) for Small, Medium and Large Office Buildings – ASHRAE 1093-RP.....	44
Figure 15. Measured Weekday Profile of Plug Power Density – Site 1 Office Area Showing Average (line) and Min/Max (dashes).....	45
Figure 16. Measured Weekend Profile of Plug Power Density – Site 1 Office Area Showing Average (line) and Min/Max (dashes).....	45
Figure 17. Measured Weekday Plug Load Profile of Site 5 (November 1999 – September 2000) Source: Naoya Motegi and Mary Ann Piette, “From Design Through Operations: Multi-Year Results from a New Construction Performance Contract”, 2002 ACEEE Summer Study	46
Figure 18. CalArch Benchmarking Tool Results, Office Building Electricity Use Intensity, PG&E and SCE Data (indicated by different colors) for Total of 236 Buildings	48
Figure 19. CalArch Benchmarking Tool Results, Office Building Gas Use Intensity, PG&E Data for Total of 43 Buildings.....	48
Figure 20. Measured CO ₂ Levels At Site #4 on February 7 th , 2003.....	54
Figure 21. VAV Hot Water Reheat Box Control - Single Maximum	58
Figure 22. VAV Hot Water Reheat Box – Dual Maximum.....	60
Figure 23. Sample VAV Box Inlet Sensor Performance Chart, CFM vs. Velocity Pressure Signal.....	67

Figure 24. Site 3 VAV Box Demand, 7am Monday August 5, 2002.....	71
Figure 25. Site 3 VAV Box Demand, 9am Monday August 5, 2002.....	71
Figure 26. Site 3 VAV Box Demand, 5pm Monday August 5, 2002.....	72
Figure 27. Dual Duct - From Cooling to Heating.....	73
Figure 28. Dual Duct - From Heating to Cooling.....	74
Figure 29. Dual Duct Mixing - From Cooling to Heating.....	75
Figure 30. Dual Duct Mixing - From Heating to Cooling.....	75
Figure 31. Examples of Poor and Better Duct Design.....	85
Figure 32. Pressure Drop Through Elbows.....	86
Figure 33. Pressure Drop Through Rectangular Tees.....	87
Figure 34. Pressure Drop Through Duct Taps.....	88
Figure 35. Example of Duct Sizing Using the Friction Rate Reduction Method.....	90
Figure 36. Poor Discharge Configuration Resulting in Significant Fan System Effect.....	94
Figure 37. Measured Pressure in a System with Significant Fan and Duct System Effect ...	95
Figure 38. Comparison of Hot Day Simulation Results for Three Supply Air Temperature Setpoints: 50°F, 55°F, and 60°F. August 18. Sacramento Climate.	100
Figure 39 – Comparison of Mild Day Simulation Results for Three Supply Air Temperature Setpoints: 50°F, 55°F, and 60°F. March 4. Sacramento Climate.....	101
Figure 40. Recommended Supply Air Temperature Reset Method.....	102
Figure 41. A Typical Manufacturer’s Fan Curve (60" Plenum Fan).....	110
Figure 42. Three-Dimensional Fan Curve for 66" Plenum Airfoil Fan.....	111
Figure 43. Three-Dimensional Fan Curve for 49" Housed Airfoil Fan.....	111
Figure 44. Gamma Curve.....	112
Figure 45. Gamma Curves for Four Fan Types.....	113
Figure 46. Gamma Curves for Several Fan Types and Sizes.....	113
Figure 47. Gamma Curves for All Cook Housed Airfoil Fans.....	114
Figure 48. Gamma Curves for All Greenheck Housed Airfoil Fans (Non-Surge Region Only)	114
Figure 49. Gamma Curves for Some Cook Backward Inclined Fans.....	115
Figure 50. Gamma Curves for All Cook Airfoil Mixed Flow Fans.....	115
Figure 51. Case Study A - Selection Software - Housed Airfoil and BI Choices.....	117
Figure 52. Case Study A - Selection Software - Plenum and Mixed Flow Choices.....	117
Figure 53. Case Study A - Selection Software - Plenum Choices at Lower Design Pressure	118
Figure 54. Case Study A - 66" Plenum Fan Design Point.....	118
Figure 55. Case Study A - 60" Plenum Fan Design Point.....	119
Figure 56. Case Study A - System Curves.....	120
Figure 57. Case Study A - Design Point Efficiency.....	120
Figure 58. Case Study A - Part Load Fan Efficiency.....	121
Figure 59. Case Study A - Part Load Efficiency (Non-surge Region Only).....	121
Figure 60. Case Study A - kW versus CFM.....	122
Figure 61. Case Study A - Gamma Curves.....	123
Figure 62. Case Study A - Load Profiles.....	124
Figure 63. Case Study A Results - Perfect Static Pressure Reset.....	124
Figure 64. Case Study A Results – No Static Pressure Reset.....	125
Figure 65. Case Study A - Acoustic Data (No Casing).....	126
Figure 66. Case Study A – Carrier Acoustic Data (With Casing).....	126
Figure 67. Case Study A - Cook Budget Prices.....	129
Figure 68. Case Study B - Selection Software Airfoil and Plenum Fans.....	130
Figure 69. Case Study B - 73" Plenum Fan Curve.....	130
Figure 70. Case Study B – 66" Plenum Fan Curve.....	131
Figure 71. Case Study B - Monitored Data.....	131
Figure 72. Case Study B - Histogram of CFM.....	132
Figure 73. Case Study B – Part Load Fan Efficiency.....	132

Figure 74. Case Study B Simulation Results - No Static Pressure Reset.....	133
Figure 75. Case Study B Simulation Results - Perfect Static Pressure Reset.....	134
Figure 76. Plan View of Site 1 Air Handler.....	135
Figure 77. Velocity Profile Off of Housed Fan.....	135
Figure 78. Temtrol Plenum Fan Data	136
Figure 79. Peak Efficiency of Cook vs Greenheck Housed Airfoil Fans	137
Figure 80. SP Setpoint vs Fan System Energy	138
Figure 81. Monitored Data Illustrating Static Pressure Reset.....	140
Figure 82. Optimal Staging (No Static Pressure Reset).....	141
Figure 83. Optimal Staging (Perfect Static Pressure Reset).....	142
Figure 84. Optimal Staging Point vs. Minimum Duct Static Pressure Setpoint.....	142
Figure 85. Optimal Staging Point for Two Fan Types.....	143
Figure 86. Parallel Fans in Surge	143
Figure 87. "Paralleling" - High Flow.....	144
Figure 88. "Paralleling" - Low Flow	144
Figure 89. VAV Reheat System with a Fixed Minimum outdoor air Damper Setpoint.....	152
Figure 90. Energy Balance Method of Controlling Minimum outdoor air	154
Figure 91. Return Fan Tracking	155
Figure 92. Airflow Measurement of 100% outdoor air.....	156
Figure 93. Injection Fan with Dedicated Minimum outdoor air Damper	157
Figure 94. Minimum outdoor air Damper With Pressure Control	158
Figure 95. Airside Economizer Configuration with Barometric Relief from ASHRAE Guideline 16-2003.....	160
Figure 96. Airside Economizer Configuration with Relief Fan from ASHRAE Guideline 16- 2003.....	161
Figure 97. Airside Economizer Configuration with Return Fan from ASHRAE Guideline 16- 2003.....	163
Figure 98. Airside Economizer Control Staging from ASHRAE Guideline 16-2003	163
Figure 99. Electronic Enthalpy High Limit Controller.	165
Figure 100. Site #1 – Office Building in San Jose.....	166
Figure 101. Site 1, Monitored HVAC Electricity End Uses	168
Figure 102. Site 1, Monitored HVAC Electricity End Uses	169
Figure 103. Site #2 – Speculative Office Building in San Jose, CA.....	169
Figure 104. Relief Fan (one of six per penthouse).....	171
Figure 105. Relief Fan Discharge	171
Figure 106. Site #3 – Southwest Corner View (Main Entrance).....	172
Figure 107. Site #3 – Northwest View	172
Figure 108 – Monitored Cooling Loads for a Sample of Three Interior Zones, Site 3 (Office)	174
Figure 109. Site #4 – Federal Courthouse at Sacramento	174
Figure 110. Site #5 – Office Building in Oakland.....	177
Figure 111. Buildings Summary (Source: Naoya Motegi, LBNL).....	178
Figure 112. Peak Day Fan Electric Demand, Three Sites.....	182
Figure 113. Peak Day Electric Demand, Site 1, 9/3/2002 (Cumulative Graph; Total Peak is 3.9 W/ft ²).....	182
Figure 114. Peak Day Electric Demand, Site 2, 8/9/2002 (Cumulative Graph; Total Peak is 6.4 W/ft ²).....	183
Figure 115. Comparison of Fan and Chiller Energy at Site 1 (Cumulative Graph, e.g. Combined Total is 0.30 kWh/ft ² -yr in July).....	183
Figure 116. Comparison of Fan and Chiller Energy at Site 2 (Cumulative Graph, e.g. Combined Total is 0.34 kWh/ft ² -yr in July).....	184
Figure 117. Site 3, Sample of Interior Zones, Warm Period (8/8/02 - 9/7/02).....	187
Figure 118. Site 3, Sample of Interior Zones, Cool Period (12/12/02-1/11/03).....	187

Figure 119. Site 4, Sample of Interior Zones (10/18/02-2/24/03).....	188
Figure 120. Site 3, Sample of Perimeter Zones, Warm Period (8/8/02 - 9/7/02).....	189
Figure 121. Site 3, Sample of Perimeter Zones, Cool Period (12/12/02-1/11/03).....	189
Figure 122. Site 4, Sample of Perimeter Zones (10/18/02-2/24/03).....	190
Figure 123. Total System Airflow, Site 1.....	190
Figure 124. Total System Airflow, Site 2.....	191
Figure 125. Total System Airflow, Site 3.....	191
Figure 126. Total System Airflow, Site 4.....	192
Figure 127. Site 1 (Dark bar includes Jan-May 2002 and Nov-Dec 2002, light bar covers Jun-Oct 2002).....	195
Figure 128. Site 2 (Light bar includes Jun-Oct 2002, dark bar covers Nov 2002 – Jan 2003).....	195
Figure 129. Site 3 (Light bar includes Aug-Oct 2002, dark bar covers Nov 2002 – Jan 2003).....	195
Figure 130. Site 4 (Dark bar includes Nov. 25, 2002 - Feb. 24, 2003).....	196
Figure 131. Monitored Sensible Cooling Load for an Air Handler Serving 19 Interior Zones, Site 4.....	196
Figure 132. Fan Performance Curves for Simulation.....	204
Figure 133. Average Results Across All Simulation Runs.....	205
Figure 134. San Francisco.....	207
Figure 135. Sacramento.....	207

LIST OF TABLES

Table 1: Key Recommendations.....	2
Table 2. Simulation Results and End Use Savings Fractions.....	4
Table 3. HVAC and Architectural Coordination Issues.....	15
Table 4. Example System Selection Table.....	24
Table 5. Tradeoffs Between Lower and Higher Supply Air Design Temperature (SAT).....	34
Table 6. Minimum Ventilation Rates for a Few Occupancy Types.....	35
Table 7. Lighting Power Allowances for Office Buildings.....	37
Table 8. EPD – US DOE Buildings Energy Databook (All States) 2002.....	42
Table 9. EPD – ASHRAE Standard 90.1 – 1989 Average Receptacle Power Densities (for compliance simulations).....	43
Table 10. ASHRAE Handbook 2001 Fundamentals, Recommended EPD (note that these values assume CRT monitors; the use of LCD monitors would result in significantly lower values).....	43
Table 11. UC Merced Building Energy Budgets for Classrooms, Office, and Library Buildings.....	47
Table 12. VAV Box Minimums from Five Measured Sites.....	62
Table 13. Sample Calculation of Box Minimum Flow.....	68
Table 14. VAV Box Maximum Airflows.....	70
Table 15. Summary of Sample Box Max and Min.....	73
Table 16. Comparison of Dual-Duct VAV Controls.....	76
Table 17. VAV Box Turndown with Electric Reheat.....	81
Table 18. Conditions Affecting the Impact of Supply Air Temperature Reset.....	102
Table 19. Fan Classification.....	107
Table 20. Comparison of Common VAV Supply Fan Types.....	108
Table 21. Manufacturers Air Handler Selection Software Fan Data.....	128
Table 22. Alternate Coil Selections for All Five Monitored Sites.....	149
Table 23. Summary of Minimum outdoor air Control Strategies.....	153
Table 24. High Limit Switch Requirements from Title 24.....	164

Table 25. Summary of Monitoring Site Characteristics 166
Table 26. Office Building Energy End Use Consumption from Several Sources..... 181
Table 27. Basecase Design Air Flows 201
Table 28. Airside Control Strategies for Simulation of Standard Practice and Best Practice
..... 203
Table 29. Simulation Results for Comparison of Standard Practice and Best Practice..... 203
Table 30. Supply Air Temperature Control Simulation Results..... 206

Overview

Audience & Objectives

The Advanced VAV System Design Guide (Design Guide) is written for HVAC designers and focuses on built-up variable air volume (VAV) systems in multi-story commercial office buildings in California. The Guidelines are written to help HVAC designers create systems that capture the energy savings opportunities, and at the same time feel comfortable that system performance will meet client expectations. This is a best practices manual developed through experience with design and commissioning of mechanical and control systems in commercial buildings and informed by research on five case study projects.

The recommendations address airside system design, covering fans, air handlers, ducts, terminal units, diffusers, and their controls, with emphasis on getting the air distribution system components to work together in an integrated fashion.

The Design Guide promotes and employs the concept of early design decisions and integrated design, meaning that the job of designing and delivering a successful mechanical system is a team effort that requires careful coordination with the other design disciplines, the contractors, the owner and the building operators.

A primary emphasis of this manual is the importance of designing systems and controls to be efficient across the full range of operation.

A primary emphasis of this manual is the importance of designing systems and controls to be efficient across the full range of operation. This requires care in the sizing of the system components (like terminal units) to make sure that they can provide comfort and code required ventilation while limiting the fan and reheat energy at part load. It also requires

careful consideration of the system controls integrating the controls at the zone to the controls at the air-handling unit and cooling/heating plants to make the system respond efficiently to changes in demand.

The Design Guide also presents monitored data that emphasize the importance of designing for efficient “turndown” of system capacity. Measured cooling loads and airflows for several buildings show that both zones and air handlers typically operate far below design capacity most of the time.

The intent of the information is to promote efficient, practical designs that are cost effective and can be implemented with off the shelf technology.

Key Recommendations

The Design Guide presents recommendations that are summarized per Chapter in Table 1 below.

Table 1: Key Recommendations

Integrated Design	<ol style="list-style-type: none"> 1. Engage the architect and structural engineer early to coordinate shafts for low pressure air paths. 2. Work with the architect to evaluate glazing and shading alternatives to mitigate load, glare and radiant discomfort while providing daylight, views and architectural pizzazz. 3. Prior to starting the mechanical design for any space, first consider the potential to reduce or minimize the loads on each space.
Early Design Issues	<ol style="list-style-type: none"> 4. Use simulation tools to understand the part-load performance and operating costs of system alternatives. 5. Employ a system selection matrix to compare alternative mechanical system designs. 6. Consider multiple air shafts for large floor plates 7. Place the air shafts close to, but not directly under, the air-handling equipment for built-up systems. 8. Use return air plenums when possible because they reduce both energy costs and first costs. 9. Design the HVAC system to efficiently handle auxiliary loads that operate during off hours. 10. Select a design supply air temperature in the range of 52°F to 57°F. 11. Size interior zones for 60°F or higher supply air temperature to allow for supply air temperature reset in mild and cold weather.. 12. Avoid overly conservative estimates of lighting and plug loads.
Zone Issues	<ol style="list-style-type: none"> 13. Consider demand control ventilation in any space with expected occupancy load at or below 40 ft²/person. 14. For conference rooms, use either a VAV box with a CO₂ sensor to reset the zone minimum or a series fan power box with zero minimum airflow setpoint.
VAV Box Selection	<ol style="list-style-type: none"> 15. Use a “dual maximum” control logic, which allows for a very low minimum airflow rate during no- and low-load periods. 16. Set the minimum airflow setpoint to the larger of the lowest controllable airflow setpoint allowed by the box and the minimum ventilation requirement (often as low as 0.15 cfm/ft²). 17. For all except very noise sensitive applications, select VAV boxes for a total (static plus velocity) pressure drop of 0.5” H₂O. For most applications, this provides the optimum energy balance.

Duct Design	<p>18. Run ducts as straight as possible to reduce pressure drop, noise, and first costs.</p> <p>19. Use standard length straight ducts and minimize both the number of transitions and of joints.</p> <p>20. Use round spiral duct wherever it can fit within space constraints.</p> <p>21. Use radius elbows rather than square elbows with turning vanes whenever space allows.</p> <p>22. Use either conical or 45° taps at VAV box connections to medium pressure duct mains.</p> <p>23. Specify sheet metal inlets to VAV boxes; do not use flex duct.</p> <p>24. Avoid consecutive fittings because they can dramatically increase pressure drop.</p> <p>25. For VAV system supply air duct mains, use a starting friction rate of 0.25" to 0.30" per 100 feet. Gradually reduce the friction rate at each major juncture or transition down to a minimum friction rate of 0.10" to 0.15" per 100 feet at the end of the duct system.</p> <p>26. For return air shaft sizing maximum velocities should be in the 800 fpm to 1200 fpm range through the free area at the top of the shaft (highest airflow rate).</p> <p>27. To avoid system effect, fans should discharge into duct sections that remain straight for as long as possible, up to 10 duct diameters from the fan discharge to allow flow to fully develop.</p> <p>28. Use duct liner only as much as required for adequate sound attenuation. Avoid the use of sound traps.</p>
Supply air temperature	<p>29. Use supply air temperature reset controls to avoid turning on the chiller whenever possible.</p> <p>30. Continue to use supply air reset during moderate conditions when outdoor air temperature is lower than about 70°F.</p> <p>31. Reduce the supply air temperature to the design set point, typically about 55°F, when the outdoor air temperature is higher than about 70°F</p>
Fan Type, Size and Control	<p>32. Use demand-based static pressure setpoint reset to reduce fan energy up to 50%, reduce fan operation in surge, reduce noise and to improve control stability.</p> <p>33. Use housed airfoil fans whenever possible.</p>
Coils and Filters	<p>34. Avoid using pre-filters.</p> <p>35. Specify final filters with 80 percent to 85 percent dust spot efficiency (MERV 12).</p> <p>36. Utilize the maximum available area in the air handler for filters rather than installing blank-off panels.</p> <p>37. Use extended surface filters.</p> <p>38. Consider lower face velocity coil selections ranging from 400 fpm to 550 fpm and selecting the largest coil that can reasonably fit in the allocated space.</p> <p>39. Consider placing a bypass damper between coil sections where the intermediate coil headers are located.</p>
Outside Air/Return Air/Exhaust Air Control	<p>40. For outdoor air control use a dedicated minimum ventilation damper with pressure control.</p> <p>41. Use barometric relief if possible, otherwise relief fans (rather than return fans) in most cases.</p> <p>42. For economizer control, sequence the outdoor and return air dampers in series rather than in tandem.</p> <p>43. Specify differential drybulb control for economizers in California climates.</p>

Energy Impacts

For buildings designed with the practices recommended in the Design Guide HVAC electricity savings are estimated to be reduced 25% below standard practice, corresponding to 12% of total building electricity consumption. Natural gas heating savings are estimated to be 41%. Careful design could exceed these savings. Additionally, building owners and developers can expect reduced maintenance and improved ventilation and occupant comfort.

Expected annual savings are about 1.5 kWh/ft² for electricity and 8.5 kBtu/ft² for gas, with corresponding annual utility cost savings are about \$0.20/ft² for electricity and \$0.07/ft² for gas, based on 2003 PG&E rates.²

HVAC electricity savings are estimated to be 25%, corresponding to 12% of total building electricity consumption.

The savings fractions for fan energy (57%), cooling energy (14%), and heating energy (41%) that are listed in Table 3 are based on simulations comparing standard practice to best practice for a 50,000 ft² office building, with most of the savings from supply air pressure reset controls and sizing of VAV boxes to allow for 10%

minimum flow.

Table 2. Simulation Results and End Use Savings Fractions

		Standard Practice	Best Practice	Savings	Savings Fraction
San Francisco (Climate Zone 3)					
Cooling	(kWh/yr)	111,522	89,428	22,094	19.8%
Fan	(kWh/yr)	33,231	12,613	20,618	62.0%
Heating	(kBtu/yr)	456,000	237,368	218,632	47.9%
Sacramento (Climate Zone 12)					
Cooling	(kWh/yr)	131,788	120,889	10,899	8.3%
Fan	(kWh/yr)	38,158	18,432	19,726	51.7%
Heating	(kBtu/yr)	528,800	347,901	180,899	34.2%
Average of San Francisco and Sacramento					
Cooling	(kWh/yr)				14.1%
Fan	(kWh/yr)				56.9%
Heating	(kBtu/yr)				41.1%

Typical vs. Best Practice Performance

Significant fan and reheat energy savings are possible through the design strategies promoted in this Design Guide. The potential savings are illustrated in the graphs below which present simulation results; in this example the “Standard” case is a reasonably efficient code-complying system and the “Best” case includes a number of the improvements suggested in this guideline. The result of this simulation show that fan energy drops by 50% to 60%, and reheat energy reduces between 30% and 50%.

² See the Statewide Energy Impact Report (Deliverable 3.4.1), August 2003 at URL. (tighten spacing between # and text, like footnote #1)

This example is by no means comprehensive. For example these savings do not include the impact of reducing duct pressure drop through careful design, the impact of properly designing 24/7 spaces and conference rooms, or the potential savings from demand based ventilation controls in high density occupancies. The assumptions in this example are presented in Appendix 6 – Simulation Model Description

Most of the savings are due to the efficient “turndown” capability of the best practices design and the fact that HVAC systems operate at partial load nearly all the time. The most important measures are careful sizing of VAV boxes, minimizing VAV box supply airflow setpoints, controlling VAV boxes using a “dual maximum” logic that allows lower airflows in the deadband mode, and supply air pressure reset control. Together these provide substantial fan and reheat savings because typical systems operate many hours at minimum (yet higher than necessary) airflow. Appendix 6 provides more details about this comparison, and the importance of turndown capability is emphasized by examples of monitored airflow profiles in Appendix 3 and cooling load profiles in Appendix 4.

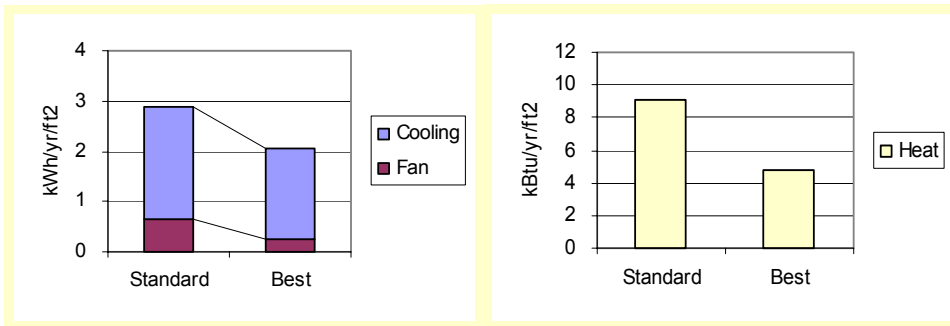

Figure 1. San Francisco

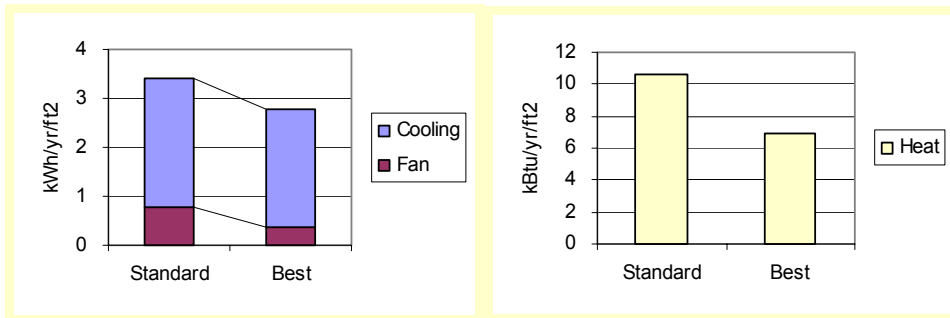

Figure 2. Sacramento

Design Guide Organization

The Design Guide Chapters are organized around key design considerations and components that impact the performance of VAV systems.

Appendices to the Design Guide present monitored data that emphasize the importance of designing for efficient “turndown” of system capacity. Measured cooling loads and airflows for several buildings show that both zones and air handlers typically operate far below design capacity most of the time.

The diagram in Figure 3 shows the Design Guide content followed by brief descriptions of each of the Chapters.

Figure 3. Overview of Guideline Contents

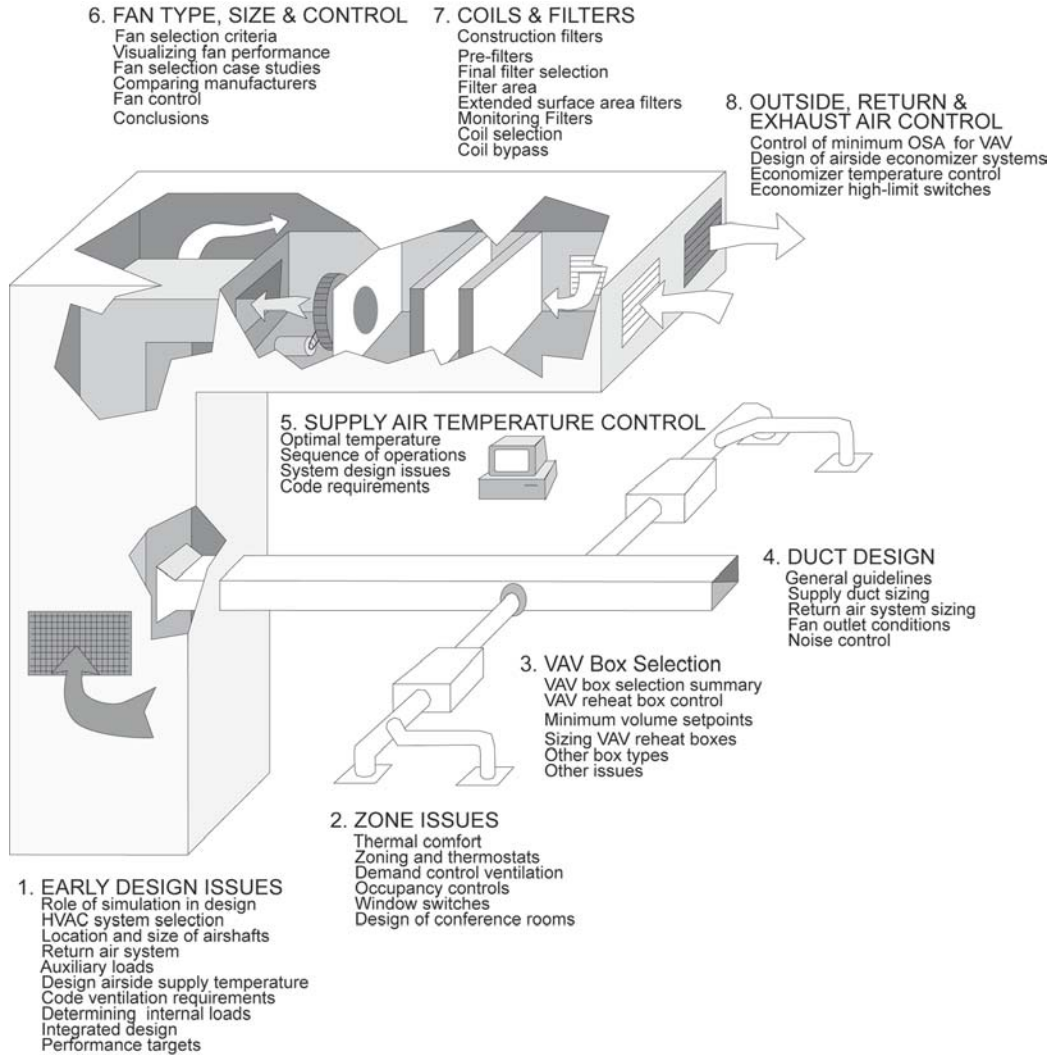

Chapter Descriptions

Introduction

The HVAC designer faces many challenges in the design of a high performing HVAC system. This chapter describes the objective of the guidelines, the role of the designer and the market share of VAV systems in California.

Early Design Issues

According to an old adage, “An ounce of prevention is worth a pound of cure.” This holds true for building design. An extra hour carefully spent in early design can save weeks of time later in the process, not to mention improve client relations, reduce construction costs, and reduce operating costs.

Zone Issues

Comfort is a complex sensation that reflects the heat balance between the occupant and their environment but is tempered by personal preferences and many other factors. This chapter covers zone design issues such as thermal comfort, zoning, thermostats, application of CO₂ sensors for demand control ventilation, integration of occupancy controls, and issues affecting the design of conference rooms.

VAV Box Selection

Selecting and controlling VAV reheat boxes has a significant impact on HVAC energy use and comfort control. This chapter examines the selection and control of VAV boxes to minimize energy usage (both fan and reheat) while maintaining a high degree of occupant comfort. Guidelines are provided for a range of terminal units including single duct boxes, dual-duct boxes and fan powered terminal units.

Duct Design

Duct design is as much an art as it is a science; however, some rules of thumb and guidelines are presented to help designers develop a cost-effective and energy-efficient duct design.

Supply Air Temperature Control

This chapter covers the selection of the design temperature set point for VAV systems in the climates of California. It also addresses energy efficient control sequences for reset of supply temperature to minimize central plant, reheat and fan energy.

Fan Type, Size and Control

A number of factors need to be considered when selecting fans, including redundancy, duty, first cost, space constraints, efficiency, noise and surge. This chapter discusses how to select fans for typical large VAV applications. Information includes the best way to control single and parallel fans, as well as presentation of two detailed fan selection case studies. Supply air pressure reset control sequences are discussed in detail.

Coils and Filters

Selection of coils and filters needs to balance energy savings against first costs. This chapter examines those issues as well as coil bypass dampers.

Outside Air/Return Air/Exhaust Air Control

Ventilation control is a critical issue for indoor environmental quality. Maximizing “free” cooling through economizers is a cornerstone of energy management. This chapter describes the design of airside economizers, building pressurization controls, and control for code-required ventilation in a VAV system.

Introduction

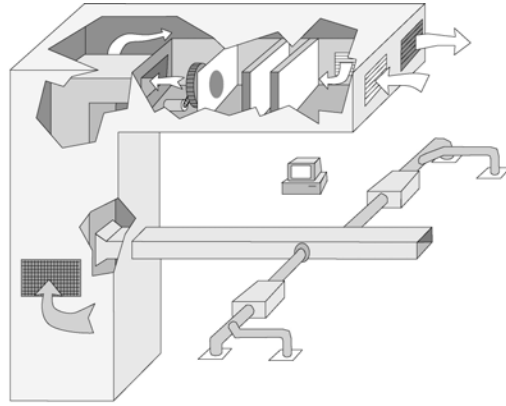

- Objective
- Market Share
- Role of Designer

Objective

The intent of the Design Guide is to promote efficient, practical designs that advance standard practice and can be implemented successfully today. The goal is having HVAC systems that minimize life-cycle cost and can be assembled with currently available technology by reasonably skilled mechanical contractors. In some cases, as noted in specific sections, increased savings might be captured through more advanced controls or with additional construction cost investment.

This document focuses on built-up VAV systems in multi-story commercial office buildings in California or similar climates.³ But much of the information is useful for a wider range of systems types, building types, and locations. Topics such as selection guidelines for VAV terminal units apply equally well to systems using packaged VAV air handlers. And recommendations on zone cooling load calculations are relevant regardless of system type.

This guide addresses airside system design, covering fans, air handlers, ducts, terminal units, diffusers, and their controls with emphasis on getting the air distribution system components to work in an integrated fashion. Other research has covered related topics that are also critical to energy efficiency such as chilled water plant design⁴ and commissioning of airside systems.⁵ The design of smaller packaged HVAC systems has also been addressed through another PIER project.⁶

Following the practices in this Design Guide can lead to major improvements in system performance, energy efficiency and occupant comfort.

³ California has 16 climate zones.

⁴ SeeCoolTools, www.hvacexchange.com/cooltools/ and the chiller analysis project www.hvacexchange.com/cooltools/CAP

⁵ See *The Control System Design Guide and Functional Testing Guide for Air Handling Systems*, available for download at <http://buildings.lbl.gov/hpcbs/FTG>.

⁶ *Small HVAC Package System Design Guide* available for download at www.energy.ca.gov/pier/buildings or at www.newbuildings.org/pier

Role of the Designer

Built-up HVAC systems are complex custom assemblies whose performance depends on a range of players including manufacturers, design professionals, installing contractors, Testing and Balancing (TAB) agents, controls technicians and operators. The designer stands in the midst of this process coordinating the activities of the

...producing a product that works for the owner within the design constraints of time and budget.

various entities in producing a product that works for the owner within the design constraints of time and budget. Due to the complexity of the process, the lack of easily accessible analysis tools and the limitations in fee and time, many choices are made based on rules-of-thumb and experience rather than analysis. In most cases, these factors lead to less than optimal performance of the resulting system.

Risk is another powerful force influencing HVAC design decisions. The penalty for an uncomfortable zone is almost always greater than the reward for an optimally efficient system. If a system is undersized, the designer may be financially responsible for the remediation, even if it is due to a change in occupancy requirements or problems in installation. Even if the designer avoids these out-of-pocket expenses, he or she will likely lose future business from an unsatisfied client. As a result, the designer is likely to be overly conservative in load calculations and equipment selection.

The design of high performing built-up VAV systems is fraught with challenges including mechanical budgets, complexity, fee structures, design coordination, design schedules, construction execution, diligence in test and balance procedures, and execution of the controls and performance of the building operators.⁷ With care however, a design professional can navigate this landscape to provide systems that are cost effective to construct and robust in their ability to serve the building as it changes through time. The mechanical design professional can also align their services and expertise with the growing interests of owners and architects in “green” or “integrated design” programs.

These guidelines are written for HVAC designers to help them create systems that capture the energy savings opportunities, and at the same time feel comfortable that system performance will meet client expectations. This is a best practices manual developed through experience with design and commissioning of mechanical and control systems in commercial buildings and informed by research on five case study projects.

Market Share

Share of Commercial Construction

The California Energy Commission predicts large office building construction volume of about 30 million square feet per year over the next ten years, equal to 20 percent of new construction in California. A reasonable estimate is that about one-half of those buildings will be served by VAV reheat systems. Therefore, these design guidelines will apply to roughly 150 million square feet of new buildings built in the ten-year period between 2003 and 2012. This estimate equals roughly 10 percent of the total commercial construction forecast.

⁷ A great treatise on the issue of barriers to design of efficient buildings is presented in “Energy-Efficient Barriers: Institutional Barriers and Opportunities,” by Amory Lovins of ESOURCE in 1992.

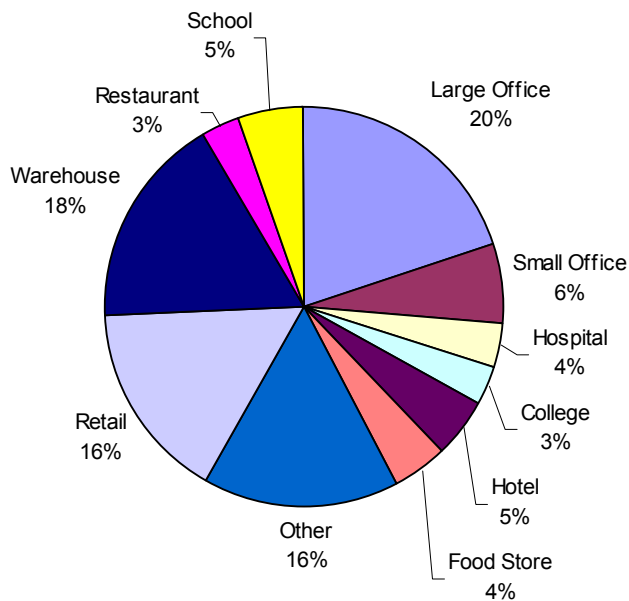

Figure 4 – Commercial New Construction Breakdown Forecast by Floor Area, Total 157,000,000 ft²/yr. Source: California Energy Commission

Other data sources indicate that the market share of VAV systems could be even higher. Direct survey data on air distribution system type are not available, but studies indicate that chilled water systems account for more than one-third of energy consumption in new construction⁸ and for about 45% of cooling capacity in existing buildings⁹. A majority of these chilled water systems are likely to use VAV air distribution. In addition some of the air-cooled equipment will also serve VAV systems. Therefore, an estimate of 10 percent of new commercial construction is likely to be a conservative estimate of the applicability of the Design Guide and prevalence of VAV systems.

Share of HVAC Market

It is important to note that chilled water systems account for only a small fraction of the total number of all commercial buildings, roughly 4%. Yet these few number of buildings account for a large amount of the statewide cooling capacity. Thus, the individuals involved in the design and operation of these buildings have a tremendous ability to affect statewide energy use based on the performance of their systems.

A review of PG&E's 1999 Commercial Building Survey Report (the CEUS data) indicates the following distribution of HVAC cooling capacity:

Direct expansion systems (55% of total cooling capacity)

- 44% direct expansion
- 10% heat pump

Chilled water systems (45% of total cooling capacity)

⁸ California Energy Commission, 2003

⁹ Pacific Gas & Electric, Commercial End Use Survey, 1999.

- 28% centrifugal chillers
- 15% reciprocating/screw chillers
- 2% absorption chillers

The fraction of the number of commercial buildings with each system type is as follows (note that sum is greater than 100% because some buildings have more than one type of cooling system):

- 78% have direct expansion cooling
- 28% have heat pump cooling
- 4% have chilled water cooling systems (including 2% centrifugal chillers, 2% reciprocating/screw chiller, and 0% absorption)

The CEUS data do not indicate the fraction of chilled water cooling system capacity that also corresponds to VAV reheat systems, but the amount should be at least 50% according to the opinion of industry experts. Based on this estimate then slightly more than 20% of all cooling capacity would be provided by chilled water, VAV reheat systems.

... slightly more than 20% of all cooling capacity would be provided by chilled water, VAV reheat systems.

Early Design Issues

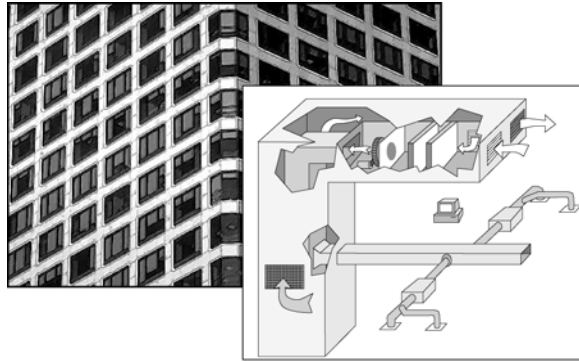

- Integrated Design Issues
- Role of Simulation in Design
- HVAC System Selection
- Location and Size of Airshafts
- Return Air System
- Auxiliary Loads
- Design Airside Supply Temperature
- Code Ventilation Requirements
- Determining Internal Loads
- Simulation and Performance Targets

According to an old adage, “An ounce of prevention is worth a pound of cure.” This holds true for building design. An extra hour carefully spent in early design can save weeks of time later in the process, not to mention improve client relations, reduce construction costs, and reduce operating costs.

This chapter includes those items that provide the greatest leverage for energy efficient airside system design. Each of these issues is described in detail in the following sections.

Integrated Design Issues

Traditional design is a fragmented process where each consultant (architect, mechanical engineer, electrical engineer...) works exclusively on the aspects of the design that fall under their scope of services. Integrated design is a process that has a more collaborative multidisciplinary approach to better integrate the building design, systems and controls.

The purpose of this section is to emphasize the importance of teamwork in the design of high performing buildings. Issues that are not traditionally the purview of the mechanical designer none the less have great impact on the cost, efficiency and success of their design. For example the glazing selected by the architect not only impacts the thermal loads but might prevent occupants in perimeter spaces from being comfortable due to visual glare or excessive radiant asymmetry. Use of high performance glazing or shading devices can drastically reduce the size of the mechanical equipment and improve occupant comfort.

***“All designs operate as
“integrated designs” whether
they were designed that way or
not”***

-Bill Reed, Natural Logic

Similarly there can be a reduction in project cost and improvement of operation if the lighting and mechanical controls are integrated in a single energy management and control system (EMCS). Consider the issue of a tenant requesting lights and

conditioning after hours. With separate systems the tenant would have to initiate two requests, one for the lighting and another for the HVAC. Similarly the building operator would have to maintain two sets of software, hardware and parts. The building manager would have to track two sets of reports for billing. In an integrated system a tenant could initiate a single call to start both systems, there would be only one system to maintain and one set of records to track.

Achieving optimal air-side efficiency requires more than just selecting efficient equipment and control schemes; it also requires careful attention to early architectural design decisions, and a collaborative approach to design between all disciplines. An integrated design process can improve the comfort and productivity of the building occupants while at the same time, reducing building operating costs. A high performance building can be designed at little or no cost premium with annual energy savings of 20%-50% compared to an average building. Paybacks of only one to five years are common. This level of impact will require a high level cooperation between members of the design team.

HVAC and architectural design affect each other in several ways. Table 3 identifies a number of coordination issues as topics for early consideration. While the list is not comprehensive, it provides a good starting point for discussions between the HVAC designer and architect.

Table 3. HVAC and Architectural Coordination Issues

Shaft size, coordination and location	Larger shafts reduce pressure loss and lead to lower fan energy. Early coordination with the Architect and Structural engineer can significantly relieve special constraints and the resulting system effects at the duct transitions into and out of the shaft. See the section titled Location and Size of Air Shafts and the chapter on Duct Design.
Air handler size	Larger face area for coils and filters reduces pressure loss. Adequate space at the fan outlet improves efficiency and may allow the use of housed fans, which are usually more efficient than plenum fans. See the chapter Coils and Filters as well as the section titled Fan Outlet Conditions in the Duct Design Chapter.
Ceiling height at tight locations	Coordinate early with the architect and structural engineer for space at duct mains and access to equipment. See the chapters on VAV Box Selection and Duct Design.
Return air path	Plenum returns are more efficient than ducted returns, but they require fire-rated construction. See the Return Air System section in this chapter.
Barometric relief	Barometric relief is more efficient than return fans or relief fans but requires large damper area and has a bigger impact on architectural design. See the chapter Outside Air/Return Air/Exhaust Air Control.
Outside air intake	Sizing and location of outdoor air dampers are especially important in California due to the savings available from air-side economizer operation. See the chapter Outside Air/Return Air/Exhaust Air Control
Acoustics	Coordinate with the architect, acoustical engineer (if there is one) and owner early to determine acoustic criteria and acoustically sensitive spaces. Work hard to avoid sound traps in the design. See Noise Control in the Duct Design chapter.
Window shading	Reduction or elimination of direct sun on the windows offers several benefits in addition to the direct cooling load reduction. Ducts and VAV boxes serving perimeter zones can be smaller and less expensive due to lower peak air flow requirements. Perhaps more importantly, the glass will stay cooler, improving the comfort of occupants near the windows (see the thermal comfort discussion in the Zone Issues section).
Window orientation	Favorable orientation can be the most cost effective solar control measure. Avoid east or west-facing windows in favor of north facing windows and south facing windows with overhangs.
Glass type	Where exterior shades and/or good orientation are not feasible, use spectrally selective glazing with low solar heat gain coefficient (SHGC).
Zoning	Grouping spaces with similar ventilation requirements, cooling loads and occupancy schedules can provide first cost savings (due to fewer zones) and energy savings (due to opportunities to shut off portions of the system). See Zoning and Thermostats in the Zone Issues chapter.

The Role of Simulation in Design

Standard design and design tools focus on equipment and system performance at “design conditions,” a static condition that occurs rarely, if at all, in the life of a mechanical system. In fact, the weather data used for mechanical heating and cooling loads is described by a metric that indicates how few hours of a typical year that design condition is expected to be met or exceeded. These design conditions may indicate performance of the mechanical equipment on peak, but they do not inform the designer on the cost of operating the mechanical system over the entire year. To understand the operating energy costs of systems and system alternatives, the designer is strongly encouraged to use simulation tools.

Simulation tools can be used to perform the important evaluation of system part load operation.

To deliver a high performing system the designer is strongly encouraged to use simulation tools. These tools assess the annual operation of building systems and design alternatives and provide a unique perspective of system performance.

Mechanical system operating costs are strongly dependant on the equipment installed, the equipment's unloading mechanism, the design of the distribution systems and the way that equipment is controlled. Consider the complexity of a built-up VAV reheat system. Energy use is a function of all of the following: the selection and staging of the supply fans; the selection and control of VAV boxes; the VAV box minimum setpoints; a duct distribution system whose characteristic curve changes with the response of the economizer dampers and VAV boxes; economizer design including provision for minimum ventilation control and building pressurization control; a pressure control loop that varies the speed or capacity of the fan(s); and possibly a supply temperature setpoint reset loop that changes the supply temperature setpoint based on demand or some proxy of demand. It would be nearly impossible to evaluate the annual energy cost impact of the range of design options by hand.

Simulation tools can be used to evaluate system part load operation. The results of the analysis inform the owner and design team of the importance of a design feature, such as the installation of DDC controls to the zone, for example. Research indicates savings can be realized of about 50% of the fan system energy by demand-based reset of supply fan pressure (Hydeman and Stein, 2003). That energy savings, along with the improvement in comfort and diagnostic ability to detect and fix problems, may be an important part of convincing an owner to pay the premium for installation of these controls (a premium of approximately \$700/zone over pneumatic or electronic controls)¹⁰.

Simulation can also be used to perform whole building optimization. For example it can demonstrate the integrated effects of daylighting controls on the lighting electrical usage and the reduced load on the HVAC systems. It can also be used to assess the reduction in required system capacity due to changes in the building shell and lighting power density.

So, if simulation tools can help to evaluate and improve designs, what is the resistance in the marketplace to using them? Here is a list of possible concerns:

1. The tools are expensive.
2. The tools are complex and take too much time to learn.
3. The time that we spend doing these evaluations will not be compensated in the typical fee schedule.
4. The owner doesn't really value this extra effort.

This is not a complete list, but it does cover a range of issues. The points below address each of these in turn.

1. *Tool Expense:* Simulation tools are no more expensive than other engineering and office software that engineers currently use, and some programs do not have any cost at all. The California utilities have developed a powerful simulation tool called eQuest that is distributed free of charge (see <http://www.energydesignresources.com/tools/equest.html>). Market based products are typically between \$800 and \$1,500 per license, a common price

¹⁰ Prices based on cost comparisons of recent projects.

range for load calculation tools. Both Trane and Carrier have simulation tools that can be added to their popular design load software for an additional cost.

2. *Tool Complexity:* Many of the current simulation tools have simple wizard driven front-ends that can be used to quickly develop building models and descriptions of mechanical systems. Both eQuest (see above) and VisualDOE (<http://www.eley.com>) have well developed wizards that allow users to build a multiple zone model in 15 minutes or less. In addition both of these programs can import AutoCAD DXF files to use as a basis for the building's geometry. Trane's Trace and Carrier's HAP use the same input as provided to their load calculation programs to do simulation analysis, and California PIER research has produced GBXML protocols to link Trane's Trace to AutoCAD files (see <http://www.geopraxis.com> and <http://www.gbxml.org/>). On the horizon, a group of software programmers are developing a protocol for building industry software interoperability (called the International Alliance for Interoperability (IAI), the Building Services Group (BSG), http://www.iai-international.org/iai_international/). These protocols have already been demonstrated linking 3-D CAD programs, thermal load programs, manufacturer's diffuser selection software and programs for sizing ductwork. All of these programs utilize the same geometric description of the building.
3. *Concerns about Time and Fees:* Many firms currently perform simulation analysis as a routine part of their design practice with no increase in design fees. This is due in part to the advent of simpler software and interfaces, as well as increased market demand for these services. Both the Green Building Council's Leadership in Energy & Environmental Design (LEED, <http://www.usgbc.org>) and the California utilities' Savings By Design Program (<http://www.savingsbydesign.com/>) require building simulation as part of their applications. In the case of the Savings by Design Program, incentives for the design team can more than make up for the additional time needed to do simulation. Simulation is also required for compliance with California's Title 24 building energy code when the building fails to meet one or more prescriptive requirements, such as if glazing areas exceed the limits of 40% window-to-wall ratio or 5% skylight-to-roof ratio.
4. *What Owners Value:* Owners value projects that come in under budget, generate high degrees of occupant satisfaction, and result in few headaches throughout the life of the building. During the California electricity curtailments of 2000 and 2001, owners were acutely aware of the efficiency of their buildings and performance of their mechanical systems. Owners with mechanical and lighting systems that could shed load did and appreciated the design features that allowed them to do so. New utility rates are in development to provide huge incentives for owners with systems that can load shed on demand from the utility. Although design fees are paid before the building is fully occupied, relationships are made or broken in the years that follow. Buildings that don't work well are discussed between owners at BOMA (Building Owners and Managers Association), IFMA (International Facility Managers Association) and other meetings, and between operators in their union activities and contractors in their daily interactions with one another. Owners value buildings that work.

To get high performing buildings, building energy simulation should be an integral part of design at all phases:

In **schematic design (SD)**, it plays a pivotal role in the selection of mechanical system (see next section) and in analysis of the building envelope. It can also be a powerful tool for communicating with architects and owners about sound

glazing, shading and orientation practices that not only reduce energy use but increase occupant comfort as well.

In **design development (DD)**, simulation can be used to refine design decisions such as evaluation of subsystem alternatives (e.g., evaporative pre-cooling), equipment selection, and distribution system alternatives.

In the **construction document (CD)**, phase, simulation is invaluable for evaluation of control algorithms and compliance with energy codes, rating systems like LEED, and utility incentive programs like Savings by Design.

In the **construction administration (CA), acceptance, and post occupancy**, phases simulation tools can be used to verify system operation and troubleshoot problems in the field.

The use of simulation tools in the design process is depicted in Figure 5 below. This figure also shows the relative roles of simulation and verification in the development of high performing buildings. Verification in this graphic includes documentation of design intent, design peer reviews, acceptance tests on systems and post occupancy monitoring and assessment.

Much of this analysis is supported by the utilities through the Savings By Design program and verification is in part supported by Pacific Gas & Electric's Tool Lending Library program and the California Commissioning Collaborative¹¹.

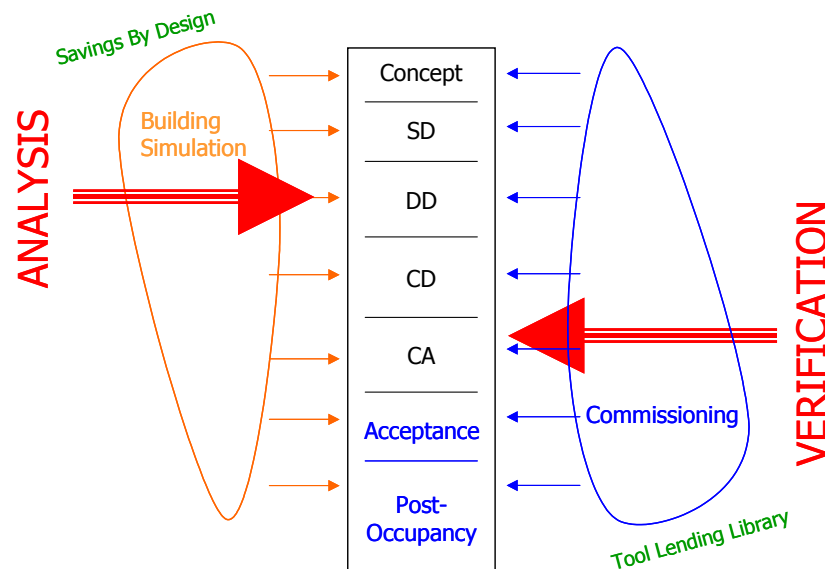

Figure 5. The Role of Simulation in Design

¹¹ The California Commissioning Collaborative The California Commissioning Collaborative is an adhoc group of government, utility and building services professionals who are committed to developing and promoting viable building commissioning practices in California. More information can be found at www.cacx.org.

Using Simulations

What is important in doing simulations for evaluation of mechanical system and architectural alternatives? How much detail is required? A study on the uncertainty of cost-benefit analysis for central chilled water plants (Kammerud et. al., 1999) found that the accuracy of the analysis is a relatively weak function of the actual load profile but a strong function of both the equipment model accuracies and economic factors (like energy costs, discount rates, etc.). In schematic and design development studies the overall building geometry needs to be correct but general assumptions for internal loads and operation schedules can be used. A reasonably accurate weather file is also needed. The details of the mechanical system should be as accurate as possible including: the design efficiency of the equipment; the part-load curves for fans, pumps, cooling and heating equipment; the controls; the zoning; and the terminal unit settings.

Design for Part-Load Operation

Monitored loads illustrate the importance of designing for efficient part-load operation. Figure 6 shows that the **HVAC system may operate at only one-half of the design airflow for the bulk of the time**. This is quite typical for office building. The design airflow for the monitored building is 0.83 cfm/ft². During cool weather, the airflow doesn't exceed 0.4 cfm/ft², and in warm weather airflow is seldom greater than 0.5 cfm/ft². Figure 7 shows similar results for cooling delivered to that floor. For additional examples, refer to Appendix 3 and Appendix 4.

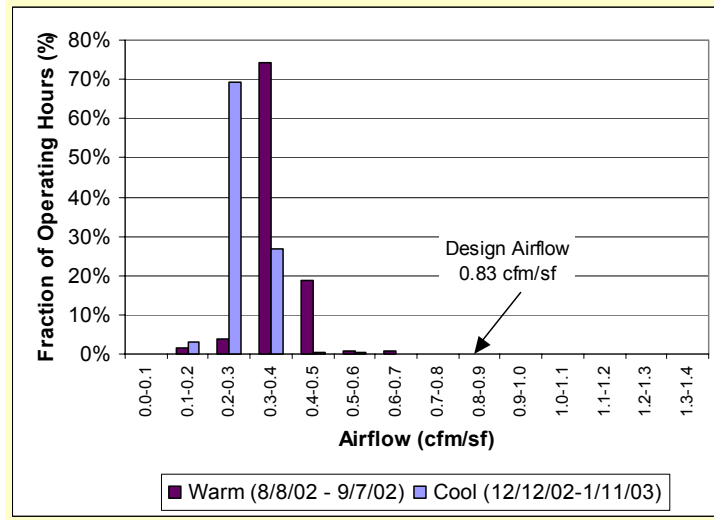

Figure 6. Measured System Airflow, Site 3

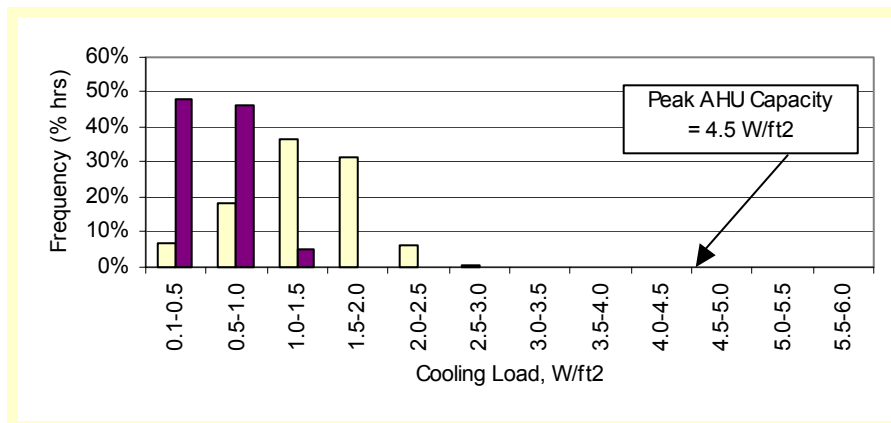

Figure 7. Measured Cooling Delivered by Air Handler, Site 3
(Light bar includes Aug-Oct 2002, dark bar covers Nov 2002 – Jan 2003)

HVAC System Selection

Mechanical system selection is as much art as science. The choice that the designer makes must balance a wide range of issues including first cost, energy cost, maintenance effort and cost, coordination with other trades, spatial requirement, acoustics, flexibility, architectural aesthetics, and many other issues. First costs depend on local labor rates for various trades, and operating costs depend on climate and energy costs. Most senior engineers over time develop a feel for what works based on past experience with the building type, climate, location, and client requirements. Although this allows them to make a decision on a timely basis it doesn't necessarily lead to the right decision in terms of optimal performance. On the other hand a pure life-cycle cost analysis ignores substantive but hard to quantify issues like ease of maintenance, occupant satisfaction and architectural aesthetics.

Like beauty, performance is in the eye of the beholder. What engineers need is a method to compare mechanical system performance over a wide range of quantitative and qualitative issues that can be customized and adjusted to the preferences of particular clients and jobs. A system selection matrix can accomplish this comparison, providing both quantitative and qualitative assessments. An example selection matrix is presented in Table 4 below. This matrix allows attributes of different systems to be compared by weighting the importance of each attribute and providing a ranking of each system with respect to each attribute. The product of the attribute weight and the system rank for each attribute and each system are then summed and compared. The higher the total score, the better the system.

A system selection matrix can accomplish this comparison, providing both quantitative and qualitative assessments.

The system selection matrix works as follows:

1. Performance attributes (important system performance characteristics) are listed in the leftmost column. These include the considerations previously discussed like costs, acoustics, aesthetics, etc....
2. In the next column is a weight representing the relative importance of each attribute. Selection of these weights will be discussed in detail later.
3. A short list of alternative systems (typically two to four) is selected by the engineer in conjunction with the other project team members.
4. For each HVAC system, a rank is assigned for each attribute. The scale ranges from 1 (worst) to 10 (best). A score of 0 could be used for total non-compliance. These scores can be on an absolute scale with a rank of 10 representing the perfect system. More commonly a relative scale is used where the system that performs best for each attribute is awarded a rank of 10 and other systems are ranked relative to that system.
5. A column is also provided for commentary on each system as it applies to each attribute.
6. The first row (System Description) is provided to give a text description of each system.
7. The bottom row is the sum of the weight times the rank ($\sum weight_i \times rank_i$) for each system.

Table 4 provides an example of a selection matrix comparing three systems (single fan VAV reheat, dual-fan dual-duct VAV and underfloor VAV with VAV fan coils) for a high-tech office building in a mild climate. This example is not a definitive comparison of these three system types for all applications but is specific to how these system types compared for a particular application using attribute weights agreed upon by the owner and members of the design team. The purpose of the example is to illustrate the process.

Table 4 reveals that this project put a high emphasis on first cost, as indicated by the very high weight (20) assigned to this attribute. By comparison, energy efficiency and maintenance were assigned weights of only 10 each. Clearly this owner was most concerned about bringing the project under budget, which is typical of most commercial projects. Other heavily-weighted categories are impact on the other trades (general contractor), comfort, and indoor air quality.

The selection of weights is meant to reflect the relative importance of each attribute to the owner. Although the weights could be assigned at any relative level, the total of the weights should be limited to 100. This has two important effects: 1) it forces the team to reflect on the relative importance of the selection criteria, and 2) the weights represent a % of total score across attributes. Often in assigning the weights the team discovers attributes that are unimportant and can be eliminated.

Walking through the example in Table 4, the first row has the descriptions of the systems being compared. The second row contains a comparison of the first cost of these three systems. In our example, this attribute has a weight of 20 (out of 100 total). The VAV reheat and dual-fan dual-duct VAV systems were awarded the same rank of 8 out of 10. As indicated in the comments, the core and shell costs for VAV reheat are lower than the dual-fan dual-duct VAV system but the dual-fan dual duct system has lower zone costs (due in part to the differential in labor cost between sheet metal and piping). Overall installed costs of these two systems are about the same but they are higher than the underfloor system (for the HVAC costs). The under-floor system has significantly lower core and shell costs, lower internal zone costs but higher perimeter zone costs. It received a rank of 10 out of 10. For this row the scores are the weight times the system score, or 160 for the VAV reheat and dual-duct VAV systems and 200 for the raised floor system.

Adding up the weights times the system ranks for each row produces the final scores in the last row: 810 for the VAV reheat; 815 for the dual-fan dual-duct VAV system, and; 883 for the under floor system. The system with the highest score “wins.”

The advantages of this method are:

1. The design team and owner are forced to focus and agree on what system features are most important for the project. This is embodied in the weights that are applied to each attribute and in the selection of the attributes to consider.
2. Both soft and hard factors can be compared in an objective manner. Scores can reflect relatively precise factors, such as simulated energy performance and first costs, as well as hard to measure factors such as perception of comfort.
3. It inherently documents the design intent. It also communicates the design intent to the other design team members.
4. It has more rigor than simply choosing a system based on “experience.”

Similar matrices can be used to select contractors. Experience has shown that it does not take much time to set up or evaluate and that owners and architects appreciate the effort. It also has been a learning experience that sometimes provides

unexpected results: what the designer expects to be the answer is not necessarily the end result in each case. The process of developing the matrix and filling it in informs designers about the strengths and weaknesses of various systems and alternatives.

Table 4. Example System Selection Table

Performance Attribute	Weight	VAV Reheat System	Rank	Dual Fan Dual Duct System	Rank	Raised Floor System	Rank
System Description		Central cooling fan systems on roof supply 55°F to 60°F air in ceiling mounted ducts to VAV reheat boxes in perimeter zones, cooling-only or reheat boxes in interior zones. Return air by ceiling plenum. Cooling fans have 100% outdoor air economizers.		Central cooling fan systems on roof supply 55°F to 60°F air, and central heating fans supply 95°F to 100°F air, in ceiling mounted ducts to dual-duct VAV boxes in perimeter zones, cooling-only or dual-duct boxes in interior zones. Return air by ceiling plenum. Cooling fans have 100% outdoor air economizers. Heating fans supply 100% return air.		Central cooling fans supply 63°F to 65°F air to 14” to 18” raised floor plenum using minimal ductwork. Air to interior zones is delivered by individually adjustable “swirl” diffusers. Perimeter zones are served by underfloor variable speed fan-coils that draw air from the underfloor plenum. Return air by reduced height ceiling plenum or by central shafts with no ceiling at all. Cooling fans have 100% outdoor air economizers.	
HVAC First Costs	20	Low shell & core costs. Highest zone costs.	8	Low zone costs usually offset higher shell & core cost resulting in slightly lower overall costs compared to VAV reheat	8	Elimination of ductwork typically results in lowest shell & core costs. Interior zone costs lowest due to eliminated VAV boxes and ductwork. Perimeter zone costs highest due to cost of fan-coil and small zones. Overall costs should be \$1 to \$2/ft ² or so lower than others.	10
Impact on Other Trades: General Contractor	10	Smallest equipment rooms or wells and shafts. Furred columns required for hot water piping.	10	Larger penthouse space required for heating fans.	9	Raised floor raises cost significantly (\$7 to \$8/ft ²). (Net overall add including mechanical and electrical is about \$3/ft ²). Penthouse space similar to reheat system. Typically more vertical shafts required.	1
Impact on Other Trades: Electrical Contractor	5	Fewer units to wire mechanically. Poke-through system for tenant improvement.	7	Slightly higher cost compared to reheat due to added heating fan, often offset by eliminating boiler. Poke-through system for tenant improvement.	7	Perimeter fan-coils require power. Underfloor wiring reduces tenant improvement wiring costs, particularly with future revisions.	10
Floor Space Requirements	5	Smallest shafts required.	10	Somewhat larger shafts required for additional heating duct.	9	More shafts required in order to properly distribute air with minimal underfloor ducts; total area slightly larger than VAV reheat.	9

Performance Attribute	Weight	VAV Reheat System	Rank	Dual Fan Dual Duct System	Rank	Raised Floor System	Rank
Ceiling Space Requirements	5	Significant duct space required above ceiling.	9	Usually extra heating duct can fit into same space as cooling duct (with cross-overs between beams) but will not work well with flat slab structure.	8	May reduce floor-to-floor height a few inches if exposed structure (no ceiling). Works very well with concrete flat-slab without ceiling.	10
Energy Efficiency Normal Operation	10	Reheat system causes high heating costs.	7	Reduced reheat and heat recovery from recessed lights reduces overall energy costs compared to reheat system	8	Reduced duct losses provide central fan energy savings, offset somewhat by perimeter fan-coil fan energy. Better economizer and chiller plant performance due to high supply air temperature. Coupling of mass with supply air can reduce cooling peaks. Reduced reheat in exterior spaces due to low minimum volumes required due to floor supply.	10
Energy Efficiency Off-hour Operation	2	VAV boxes may be used to isolate unoccupied areas to minimize off-hour usage.	10	VAV boxes may be used to isolate unoccupied areas to minimize off-hour usage.	10	No VAV boxes to isolate flow to unoccupied areas. Each floor may be isolated using smoke dampers. Unlikely to need chillers at night due to high supply air temperature.	9
Smoke Control (7 story buildings)	3	Outdoor air economizer and relief fans may be used for smoke control.	10	Same as VAV	10	Same as VAV.	10
Acoustical Impact	5	Noise problems may occur near fan rooms and shafts. Slight VAV box noise and hiss from diffusers	9	Same as VAV reheat	9	Noise problems may occur near fan rooms and shafts. Very quiet interior zone supply. Perimeter fan-coils quieted by heavy floor, low velocity supply.	10
Indoor Air Quality	10	Outside air economizer allows 100% fresh air most of year.	8	Reduced outdoor air supply in winter due to 100% return air on heating fan, but minimum overall circulation rates can be higher.	7	Outside air economizer on longer due to warmer return air temperatures. Excellent ventilation efficiency with floor supply. Perception of improved air quality in interior zones due to control and floor supply	10

Performance Attribute	Weight	VAV Reheat System	Rank	Dual Fan Dual Duct System	Rank	Raised Floor System	Rank
Comfort	10	Good cooling performance on exterior zones. Fair heating performance due to stratification. Can only maintain uniform temperatures in interior open office zones; individual control not possible.	6	Same as VAV reheat	6	Individual cubicles in open office plans can be individually controlled, improving comfort both physically and perceptually. Perimeter zones are similar to VAV systems for cooling but have improved performance for heating since heat is supplied underfloor along the window-wall.	10
Maintenance Costs and Reliability	10	Only rooftop equipment requires frequent maintenance; VAV boxes occasional maintenance. Risk of water damage due to piping above ceiling.	8	No water above ceiling reduces risk of water damage. Dual duct boxes require slightly less maintenance than reheat boxes.	10	No VAV boxes in interior, but perimeter fan-coils require most maintenance, especially if fitted with optional filters. Risk of water damage due to piping below floor.	8
Flexibility	5	Any number of zones may be used, but at high cost per zone.	7	Any number of zones may be used and zone costs are less than for reheat	8	Outlets may be moved easily to accommodate changing interior layouts. Air tends to be naturally drawn to high heat load areas.	10
Total	100		810		815		883

Location and Size of Airshafts

The location and size of airshafts is an extremely important coordination item to begin early in the design process. The issue can have tremendous implication on the cost and efficiency of the mechanical systems as well as architectural space planning and structural systems. Poor shaft design or coordination will result in higher system static pressure and fan energy use.

There are a couple of general principles to employ in sizing and locating shafts:

1. Keep shafts adjacent to the building cores but as close to the loads as possible. The architect will generally prefer the shafts near the cores where there are some distinct advantages for access, acoustics, and servicing.
2. Consider multiple shafts for large floor plates (e.g. greater than 15,000 to 20,000 ft²) and under-floor systems. This can greatly reduce the installed cost of mechanical systems and reduce problems coordinating services at the shaft exits.
3. To the extent possible, place the shafts close to, but not directly under, the air-handling equipment. Leave plenty of space to fully develop airflow from the fans prior to the ductwork turning down the shaft. As described in the section on air handlers, the best acoustics result from a lined, straight horizontal run of duct before turning down the shaft. If using relief fans or return fans, prevent these fans from having line of sight to the shaft to minimize fan noise transmission down the shaft.
4. Decide on a return air scheme, either fully ducted from the fan to each return air grille, ducted only in the riser with the ceiling cavity used as a return air plenum on each floor, or fully unducted using both the ceiling cavity and architectural shaft as a return air plenum. See additional discussion in the following section. This may have an impact on the shaft area required.
5. Size the shaft for the constraints at the floor closest to the air handler. This is where the supply, return and exhaust airflows and ducts will be largest. Shaft size can be reduced as loads drop off down the shaft, but this is typically only done on high-rise buildings for simplicity.
6. Be conservative when sizing shafts initially. It is always easier to give up space than expand the shafts in the late stages of design. Also there will almost always be other items like tenant condenser water piping, reheat piping, plumbing risers, and toilet exhaust risers that will make their way into the shaft.
7. Make sure to leave ample room between the supply duct riser and the shaft wall at riser taps to provide space for a fire/smoke damper and a smooth transition from the riser into the damper. Typically at least 11" is required between the inside of the shaft wall and the edge of the duct riser. This provides 6" for a 45° riser tap, 3" for the fire/smoke damper sleeve, and 2" to connect the tap to the sleeve with a slip connection. (See Figure 9.) The more room provided between the tap and the fire/smoke damper, the lower the pressure drop through the damper since the air

velocity profile will be more uniform through the damper. However, the longer duct tap blocks the return air shaft and increases lost shaft space.

8. Coordinate with the structural engineer early on to make sure that the ceiling space where ducts tap off of risers is not blocked by beams. Structural engineers will typically select the lightest and deepest steel beams to reduce steel costs, but where added space is essential such as at shafts, beams can be made heavier and shallower with only a minor structural cost impact.
9. Look beyond the inside dimension of a duct or opening. It is critical in shaft sizing to account for physical constraints like duct flanges, hanging brackets, transitions, fire damper flanges and fire damper sleeves. If the shaft is serving as an unducted return air plenum, be sure to account for the free area lost by horizontal ducts tapping into supply and exhaust risers (see Figure 8).

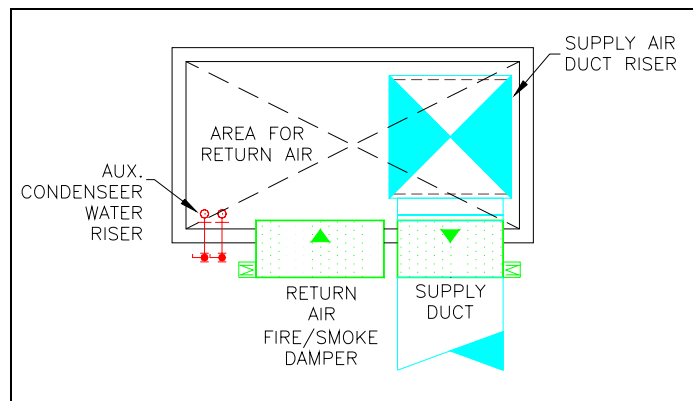

Figure 8. Typical Duct Shaft with Unducted Return

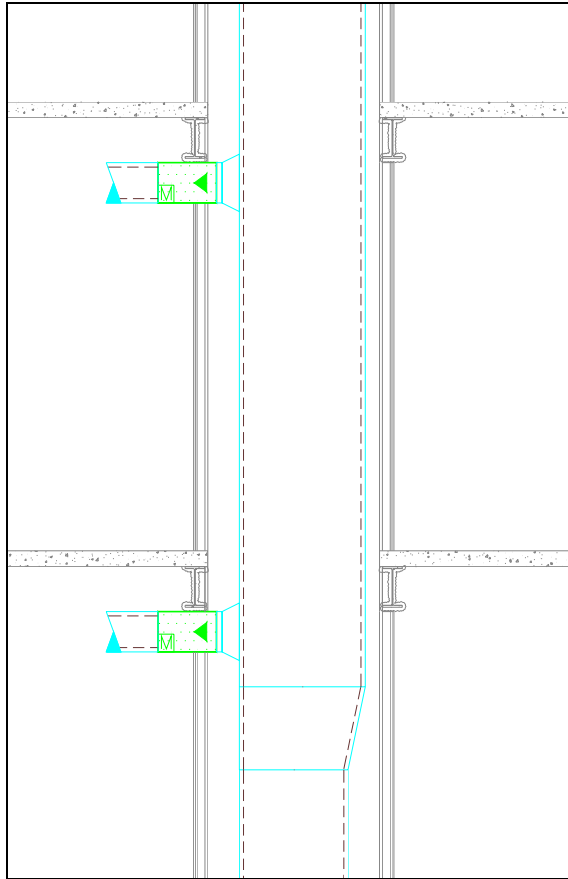

Figure 9. Typical Duct Riser

Return Air System

It is important to establish a return air system design scheme very early in the design process. It has a significant impact on the cost and complexity of the mechanical system, the size of the shafts, coordination of fire and smoke zones, space requirements for the penthouses or mechanical rooms, and operating efficiency of the mechanical system. The three most common options are:

1. Fully unducted using both the ceiling cavity and architectural shaft as return air plenums.
2. Partially ducted return, generally ducted from the fan, down the riser, and part way onto each floor into local return air plenums. (This option may be used when floors are substantially blocked by full height walls, making a low pressure fully unducted return more difficult.)
3. Fully ducted return from the fan to each return air grille.

These options will also impact the type of economizer relief system selected. Plenum returns have a very low pressure drop in general and thus either non-powered (e.g., barometric) relief or low pressure relief fans may be used. With partially or fully ducted return air systems, the pressure drop of the return air path will be relatively high, favoring the use of return air fans.

For more discussion on this issue see Taylor, S. "Comparing Economizer Relief Systems," ASHRAE Journal, September 2000.

Fully unducted plenum returns have the following advantages:

1. Plenum returns reduce energy usage due to the following factors:
 - a. Reduced fan static pressure (plenums are essentially a very large ducts) will reduce fan energy. Typically, plenum returns have static pressure drops in the range of 0.25" to 0.75" H₂O compared to a range of about 1" to 2" for fully ducted returns.
 - b. Some of the heat gain from recessed lighting and envelope will be picked up by the return air rather than becoming a space load. This reduces supply fan energy and, by increasing return air temperatures, it can extend the effectiveness of airside economizers and improve the efficiency of packaged cooling equipment.
 - c. Non-powered relief or relief fans are viable options due to the low pressure drop of the plenum return, and these types of relief systems use less energy than return air fans.
2. Plenum returns significantly reduce installed mechanical costs due to the elimination of all return air ductwork, reduced fan motor and VFD horsepower, and reduced relief system costs (non-powered relief and relief fans are less expensive than return fans).
3. Plenum returns are essentially self-balancing and thus obviate the need for balancing labor. For VAV systems, this feature also ensures that individual spaces will not be negatively pressurized as supply air flows change. With fully ducted returns, return airflow does not track supply air flow changes at the zone, and as a result air balance to spaces and floors varies with changes in supply airflow.
4. Return plenums typically reduce the required depth of the ceiling space and shafts can be smaller because the entire free area of the shaft and ceiling are available for return airflow.
5. Return plenums greatly reduce ceiling coordination among trades by eliminating the large return air ducts and the need to cross over supply and return mains to serve zones.

However, there are some distinct disadvantages to plenum returns:

1. Using building cavities as return air plenums can draw them below atmospheric pressure if not properly designed, causing outdoor air to be drawn into the building fabric. In humid climates, this can result in condensation of moisture from outdoor air within architectural cavities, and consequently result in mold and mildew growth. Ensuring that building space pressurization (e.g., 0.05") exceeds the pressure drop from the space to the return air plenum (e.g., <<0.05") so that all building elements remain pressurized above ambient air will mitigate this problem.
2. Most building codes only allow architectural cavities to be used as air plenums if the materials exposed to the plenum meet certain flame spread and smoke generation limits. This means that ceiling plenums that are exposed to wood joists or plywood decks usually cannot be used as return air plenums.

3. Wiring (electric, control, and telecommunication) must be plenum rated.
4. Individual space pressurization control is not possible, which is a critical issue in laboratories and health care buildings.
5. Care must be taken at full height walls to be sure that adequate openings are provided for return air transfer and that the openings are acoustically treated where necessary (e.g., with lined elbows or boots).
6. Some indoor air quality (IAQ) experts have concerns that return air plenums can lead to IAQ problems due to the debris and dust that can accumulate on ceiling tiles, etc. This same dirt can also accumulate in return air ducts, of course, but ducts are more easily cleaned than large plenums. The counter-argument is that the return air plenum is upstream of particulate filters in the supply air system so dirt entrained in return air can be substantially filtered out. No studies we are aware of have shown that return air plenums result in higher particulate concentrations than ducted return air systems.

Clearly, plenum returns should not be used where codes prohibit them (e.g., due to combustible structure) or in occupancies where individual space pressures must be controlled (e.g., hospitals). They also should not be used in humid climates without very careful design to ensure that all parts of the building remain pressurized. In other applications, return air plenums are recommended because they reduce both energy costs and first costs.

Auxiliary Loads

Most buildings will require auxiliary cooling systems to serve 24/7 process loads, such as server rooms or telecom closets, and other loads that do not operate on the normal HVAC system schedule. It is important to evaluate the performance of the HVAC system when serving only these loads, which typically are a small percentage of the total building load.

There are a number of options to serve these loads:

1. Dedicated chilled water fan-coil units. With this design, the chilled water plant must be able to operate efficiently at the lowest expected auxiliary load. Typically this will require variable flow (2-way valve) distribution with variable speed pumps and unequally sized chillers or perhaps a small “pony” chiller sized for the 24/7 loads alone. Having the smaller chiller will also generally improve the chilled water plant part-load performance during low load conditions. Because these loads occur even in cold weather, energy efficiency can be improved either by installing a water-side economizer to reduce chiller load and number of operating hours or by recovering condenser heat to serve heating loads that use low-temperature hot water (90°F to 110°F), such as radiant floor heating or domestic water pre-heating.
2. Dedicated water-cooled AC units. These units are served from either the main cooling tower serving chillers (appropriately up-sized) or a dedicated cooling tower or fluid cooler. Using a heat exchanger or fluid cooler to create a closed-circuit loop is beneficial from a maintenance standpoint since it reduces condenser cleaning requirements. If the main cooling tower is used, tower cells may need to be fitted with weir dams or low-flow nozzles to allow for adequate water distribution across the tower

at low flow rates. Also, head pressure control must be considered if the tower is controlled to provide low condenser water temperatures for optimum chiller operation (e.g., for variable speed chillers) or waterside economizer operation. This is most easily done by installing head pressure control valves at each air conditioning (AC) unit or by providing a controlled tower bypass to the loop serving the AC units. Consider using waterside economizer pre-cooling coils, offered on water-cooled computer room units as a standard option. This option is probably the most common for speculative buildings because it is inexpensive to oversize towers for future loads, and any number of auxiliary AC units can be added to the system without affecting efficiency (unlike option 1 above where the plant will not be efficient unless loads are sufficient to load the smallest chiller to 25% or so.) Like the first option this system can be configured to utilize heat recovery. It can also be configured to use a waterside economizer but that should be carefully evaluated as the extra coil cost and air-side pressure drop will offset the benefit of compressor cooling.

3. Air-cooled split systems. This is not the most efficient option but is inexpensive for small, distributed loads in low rise buildings. It is not usually practical in buildings over 5 stories or so due to distance limitations between rooftop condensing units and fan-coils.
4. VAV boxes from the central VAV air system. This option can either be the most efficient or least efficient depending on the details of the system design. To be efficient, first the system must have the ability to shut off unoccupied areas so that only auxiliary loads can be served without wasting energy serving unoccupied areas. This is easily done with modern DDC controls at the zone level; VAV boxes are simply commanded to close (or temperature setpoints are set back/up and minimum airflow setpoints set to zero) when spaces are scheduled to be unoccupied. Second, the central VAV fan system must be evaluated to see if it can operate stably when only serving auxiliary loads. If the fan system has variable speed drives, it can operate very efficiently down to about 10% of design airflow. (Note that some VFDs are configured from the factory with very high minimum speeds, such as 30% to 50%. These minimum setpoints should be reduced to 10%, which is all that should be required for motor cooling.) If the fan system has multiple fans with backdraft dampers, the fans may be staged to provide efficient operation at even lower airflow rates. Third, the cooling plant must be capable of operating efficiently at low loads as described for option 1 above. If all three of these capabilities are provided, this option can be the most efficient because fan energy is very low (the variable speed drives will provide cube-law performance as the airflow drops, partially offset by reduced motor efficiency at low load) and the central airside economizer can be used to provide free cooling in cool and cold weather (which is a common condition during nighttime operation). However, if large areas must be conditioned to operate the fans or chiller plant stably, this option becomes the least efficient.

Design Airside Supply Temperature

What's the best choice for supply air temperature? A designer needs to answer that question at a fairly early stage in order to calculate airflow

requirements and equipment size. The short answer for VAV systems in California is, “somewhere around 55°F”, which happens to be a common rule-of-thumb. The long answer is a bit more complex; a designer might say, “it depends...” It depends on factors like chilled water system efficiency at different temperatures. It depends on the cost of real estate (i.e. space for shafts and ducts within the building). It depends on the local climate and the number of potential economizer free cooling hours and the need for dehumidification. Therefore, choosing an optimal design temperature can involve a complex tradeoff calculation.

It turns out that “somewhere around 55°F” (e.g. 52°F to 57°F) is a good choice for air handler design in California office buildings. It results in a good balance between efficiencies of the chilled water plant and the air distribution system at peak cooling conditions. The exact selection is not critically important. If physical space for the air handling equipment is very constrained or humidity may be a concern during cooling conditions, then choose on the lower side. Or choose a lower temperature if the building has relatively high loads in order to avoid the need for excessive peak airflow at the zone level. Otherwise, a temperature close to 55°F is appropriate, which allows the chilled water plant to operate more efficiently (through higher chilled water temperature and/or lower chilled water flow). It also reduces the likelihood that reheat will be required in some zones. A higher temperature also saves some energy by reducing unneeded latent cooling (this is only a benefit in fairly dry climates) and by extending the number of hours the economizer can handle the entire cooling load, which reduces the number of hours the chiller plant operates at low loads.

What happens at higher or lower supply air temperature? If the air handler is selected to provide higher temperature, say 60F, at peak periods, then the additional fan energy typically exceeds the savings from more efficient chiller operation and extended economizer operation. If the supply air temperature is lower, then fan energy drops while chiller and reheat energy increases. Systems designed for very low air temperatures (40° to 50°F) are generally not a good choice in mild California climates. (See Bauman et al.) Low supply air temperature can be a better choice in warm and humid climates where there are fewer potential economizer hours and dehumidification is important.

The optimal supply temperature is usually in the mid 50s at peak conditions.

Table 5. Tradeoffs Between Lower and Higher Supply Air Design Temperature (SAT)

Lower SAT	Higher SAT
Less fan energy, due to lower airflow. However, if series fan-powered boxes are used to prevent the direct supply of cold air to spaces, fan energy will be higher than 55°F air systems.	Less chiller energy due to greater chiller efficiency at higher chilled water temperature.
More dehumidification (desirable in humid climates, but a potential waste of energy in dry regions).	Less reheat energy.
Lower construction cost (potential for smaller air-side system components that require less space and may be less expensive).	Potential for higher chilled water delta-T, which leads to lower pumping energy.
	Larger airflow capacity increases opportunity for economizer savings under mild conditions.
	Higher airflow rates which may improve indoor air quality and comfort.

An important point to note is that supply air temperature reset control is ultimately more important than the choice of design air temperature. A system designed for 55°F can still operate at 60°F. Title 24 currently requires supply temperature setpoint reset, and appropriate reset control strategies are described in detail below in the section Supply Air Temperature Control.

Supply Air Temperature for Interior Zone Sizing

For interior zones, Title 24 currently requires that the supply air temperature used for zone airflow calculations and VAV box sizing shall be the fully reset (warmest) temperature. If this was not done, one or more interior zones could require 55°F air when the perimeter zones have little cooling load, causing excessive reheat and increased the chiller operation.

Code Ventilation Requirements

For commercial buildings in California other than UBC type “I” occupancies (principally prisons and hospitals), Title 24 sets the ventilation requirements. Section 121 (b) 2. requires mechanical ventilation systems be capable of supplying an outdoor air rate no less than the larger of:

- A. The conditioned floor area of the space times the applicable ventilation rate from Table 1-F¹²; and
- B. 15 cfm per person times the expected number of occupants. For spaces without fixed seating, the expected number of occupants shall be assumed to be no less than one half the maximum occupant load assumed for exiting purposes in Chapter 10 of the CBC. For spaces with fixed seating, the expected number of occupants shall be determined in accordance with Chapter 10 of the CBC.

The outdoor air requirement thus has two components: an occupant-based component and a building- or area-based component. The design outdoor air

¹² This table is now Table 121-A in the 2005 Standards.

rate must be the larger of the two. Based on the lowest allowed occupancy density assumption allowed by Section 121 (b) 2. A., the code-minimum ventilation rate is calculated for a few common occupancy types in Table 6.

Table 6. Minimum Ventilation Rates for a Few Occupancy Types

Space Type (without fixed seating)	Ventilation based on Occupants			Ventilation based on Area from Table 1-F CFM/ft ²	Overall Minimum Ventilation Rate (CFM/ft ²)
	CBC Occupant Load Factor from Table 10-A (ft ² /person)	Expected Occupant Load = Twice CBC (ft ² /person)	Outdoor air Rate (CFM/ft ²)		
Auditorium	7	14	1.07	0.15	1.07
Conference room	15	30	0.50	0.15	0.50
Classroom	20	40	0.38	0.15	0.38
Office	100	200	0.08	0.15	0.15
Retail - ground floor	30	60	0.25	0.2	0.25
Retail - upper floors	60	120	0.13	0.2	0.20
Library - reading area	50	100	0.15	0.15	0.15

There is a very important exception to Section 121 (b) 2. that states

EXCEPTION to Section 121 (b) 2: Transfer air. The rate of outdoor air required by Section 121 (b) 2 may be provided with air transferred from other ventilated spaces if:

- A. None of the spaces from which air is transferred have any unusual sources of indoor air contaminants; and
- B. Enough outdoor air is supplied to all spaces combined to meet the requirements of Section 121 (b) 2 for each space individually.

This exception simplifies the calculation of outdoor air rates by assuming that once outdoor air is brought into a system, it will be properly distributed to each zone served by the system. Two results of this exception include:

- The minimum outdoor air to be provided at an air handling system is equal to the sum of the ventilation requirements of each zone served by the system. So-called “multiple spaces” effects (see ASHRAE Standard 62-2001 section 6.1.3.1) do not have to be taken into account.
- The minimum rate of air supplied to a space is equal to the minimum ventilation rate even if the supply air is partly or fully composed of air returned or transferred from other ventilated spaces. It need not be air supplied directly from the outdoors.

Even with the simplified assumption at the zone level, the Title 24 ventilation rates are very similar to the rates that from the recently approved Addendum 62n to Standard 62 so they should result in acceptable air quality. Also in the mild climates of California the ventilation rates at the system level often exceed the minimum due to operation of air-side economizers.

Determining Internal Loads

An understanding of internal loads (lighting, plug loads, and heat from occupants) is important both for sizing equipment and for determining the required part-load performance. This section provides guidance on

estimating internal heat gains from lighting, plug loads and occupants. In addition to addressing peak loads, this section also addresses the frequency and range of internal loads to emphasize the importance of designing systems for efficient part-load operation. Appendix 4 includes measured loads from several buildings, providing examples of cooling load profiles.

Oversizing

The effects of equipment oversizing depend on the system or component being considered. An oversized chiller or boiler will have higher first costs, require more space, have higher standby losses, and may use more energy than a properly sized unit depending on how it unloads. As discussed below, an oversized fan may be more efficient at design conditions, but if it is not properly controlled it will use more energy at part-load and may spend significant time in surge. Oversized cooling towers and coils in general will reduce operating costs but may cause control problems at low loads due to unstable heat transfer characteristics. Oversized ductwork and pipes will always reduce energy cost but at a first cost premium. In all cases, oversizing will cost the owner more and gross oversizing will be easily recognized in the field by observation of equipment performance. Most owners don't like paying for equipment that sits idle. However, they also want the flexibility of systems that can accommodate changes in building loads or operation.

Systems should always be designed to turn down efficiently. This can accommodate moderate over sizing, reduction of loads due to changes or reductions in tenant spaces and operation at off design conditions. Almost all systems will have some amount of over sizing due to inaccuracies in the load assumptions and techniques, the desire of engineers to be conservative to avoid liability and the need of owners to have future flexibility. Designs can accommodate some over sizing and turndown without a significant energy penalty by doing the following:

- Provide multiple pieces of central equipment (chillers, boilers, towers, fans and pumps) in parallel to allow staging at low loads. Staging reduces standby losses and inefficient operation at low loads from motors and fixed speed equipment.
- Using variable speed drives which can effectively reduce equipment capacity automatically and very efficiently down to about very low loads. With variable speed drives equipment staging is less of an issue.

Simulation can be used to evaluate system operation over the range of anticipated loads and to test the system performance over a range of design loads.

Lighting Loads

Lighting is the easiest of the internal heat gains to predict. Data regarding the energy consumed by lighting systems is widely available, and lighting power limits are specified by Title 24. Even the controls—the one uncertain aspect of lighting load—are fairly easy to characterize.

There has been a steady downward trend in lighting power, and traditional lighting load assumptions may no longer be valid (see Table 7). Many office spaces are now designed with less than 0.8 W/ft² of lighting. Recent

technologies such as higher output “second generation” T-8 lamps and high efficiency electronic ballasts reduce lighting power by more than 15% compared to the industry standard T-8s and electronic ballasts. In addition, motion sensor and daylighting controls are becoming more prevalent due in part to better controls and field proven technology.

Two numbers are needed to estimate peak lighting loads for sizing calculations: the total installed lighting power and the diversity factor accounting for controls. The installed lighting power comes from the lighting plans and fixture schedule (which must indicate the input power for each type of luminaire). At early stages of design, plans may not be complete, and in that case the assumed lighting power should be no greater than the code allowance for each space type. Although this is a start, the final lighting power densities should be lower and the engineer should request revised numbers from the lighting designer at each stage in the project development. Ideally, the design team will set lighting power targets at the beginning of the design process, and there are references available to help provide reasonably attainable targets that are significantly lower than code allowances.¹³

Table 7. Lighting Power Allowances for Office Buildings

Standards	Office Building LPD (W/ft²)
ASHRAE 90.1-2001	1.3
ASHRAE 90.1-1999	1.3
ASHRAE 90.1-1989	1.5 to 1.9 depends on building size
ASHRAE 90.1-1975	2.2
CA Title 24-2005	1.1
CA Title 24-2001	1.2
CA Title 24-1999	1.2
CA Title 24-1995	1.5
CA Title 24-1992	1.5
CA Title 24-1988	2.0

The diversified lighting loads on central equipment is generally lower than the total installed power; not all lights are on all the time. Recommendations for lighting load profiles and diversity factors were developed as part of ASHRAE Research Project 1093 “Compilation of Diversity Factors and Schedules for Energy and Cooling Load Calculations.” That research provides a set of schedules and diversity factors for energy simulations (the 50th percentile schedules) and design cooling load calculations (the 90th percentile schedules). Figure 10 shows the data for offices based on measured data in 32 buildings. The schedules are grouped by building floor area:

- Small: 1,001 - 10,000 ft²,
- Medium: 10,001 - 100,000 ft², and
- Large: > 100,000 ft².

¹³ Advanced Lighting Guidelines, www.newbuildings.org.

These results show that the appropriate diversity factor for energy simulations is roughly 80% and for design cooling load calculations is about 90%.

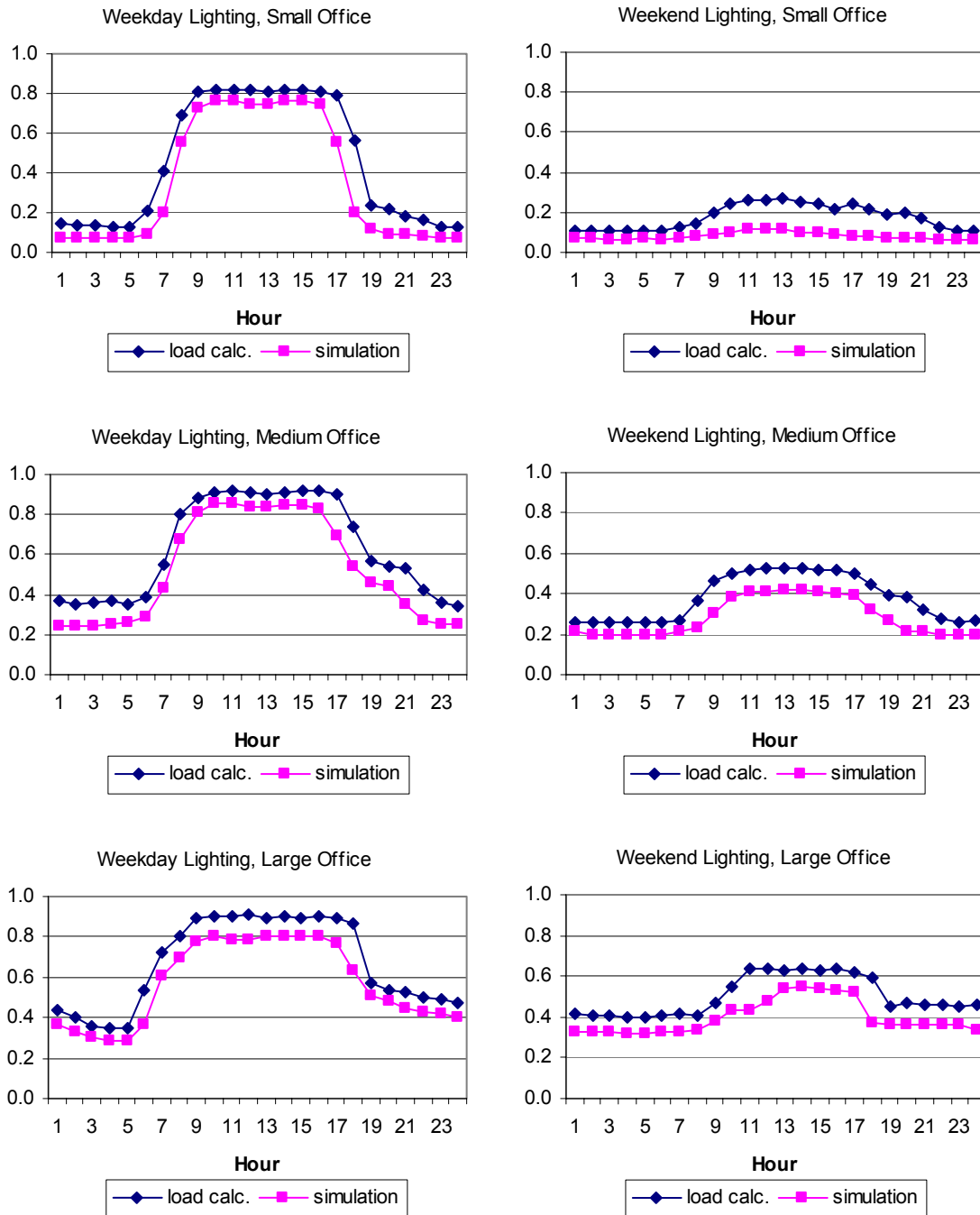

Figure 10. Measured Lighting Schedules (90th percentile for design load calculation and 50th percentile for energy simulations) for Small, Medium and Large Office Buildings – ASHRAE 1093-RP.

Where applicable, it is recommended that lighting load calculations include the impact of daylighting controls. These controls are likely to have the greatest impact during the cooling peak. If credit is taken for this peak

reduction, it is critical to get buy in from the owner and design team and to clearly document the fact that load calculations assume functioning lighting controls. Therefore, they can take some equipment downsizing credit for the lighting controls, and they will understand that eliminating the controls will require that loads be recalculated. Some may argue that peak load calculations must assume that automatic daylighting controls are not working (i.e., the lights are always on). This was not an unreasonable assumption in the early years of daylighting controls due to their notorious lack of reliability. Modern control systems are, fortunately, much more reliable particularly if thoroughly commissioned.

Motion sensor lighting controls have a big impact on lighting loads, and though it may not be appropriate to assume the lights are off for purposes of zone air flow calculations, it is appropriate to assume some level of diversity at the central equipment.

The recommendations for lighting load assumptions can be summarized as follows:

- Use peak load assumptions no greater than the installed lighting power, or no greater than the energy code allowance if lighting designs are not complete.
- Encourage the design team to set lighting power targets that are lower than code, accounting for improvements in lighting technology. Use those targets for load calculations. Use simulations to show the HVAC system impact and the economic benefits of a low lighting power density.
- Include a diversity factor for lighting loads because it is rare that all lights are on at the same time. Include consideration of occupancy sensors if they are part of the lighting design.
- Account for daylighting control savings in peak load calculations.

Monitored Lighting Loads

Measured lighting loads (15 minute intervals from 9/14/2001 to 8/15/2002) for Site 1 show a peak of 0.43 W/ft² for the third floor office area of 32,600 ft², while the installed power is about 1.2 W/ft². Therefore, actual lighting power never exceeds about 1/3 of the total installed power. These results are not representative of all buildings, but they represent what may be encountered in the field. During the monitoring period, the office areas were only about 60% occupied and every office had occupancy sensors to control the lights. The measured profile for weekdays and weekends are shown in Figure 11 and Figure 12.

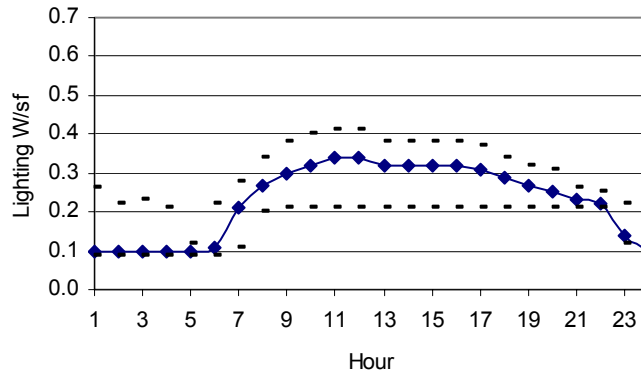

Figure 11. Measured Weekday Lighting Profile – Site 1 Office Area Showing Average (line) and Min/Max (dashes)

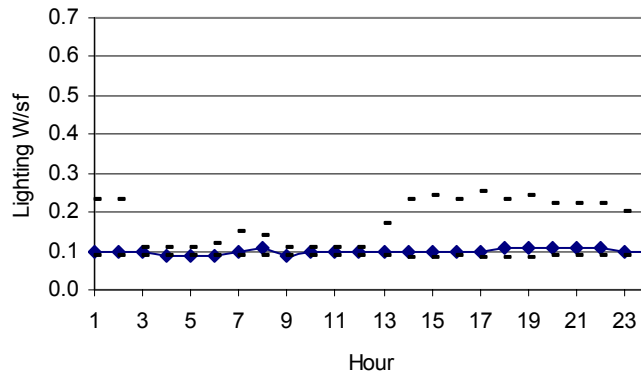

Figure 12. Measured Weekend Lighting Profile – Site 1 Office Area Showing Average (line) and Min/Max (dashes)

Plug Loads

The energy consumed by office equipment such as computers, printers, and copiers is harder to predict than lighting loads because the quantity of equipment is seldom known with certainty. However, there is a great deal of information and data available to assist with estimates. Almost all studies where plug loads were measured show that actual loads are much lower than what is indicated from nameplate ratings and much lower than commonly used design values.

An important point to remember is that equipment nameplate power is not the actual power consumed by the equipment either at peak or part load conditions; it is typically just the rating of the power supply. The heat gains from internal equipment are always much less than the nameplate power (Figure 13).

The general recommendation to the designer is that zone airflow be sized to handle reasonably anticipated peak plug loads (which requires some judgment), but that the more likely typical plug loads be used to evaluate system performance at normal loads.

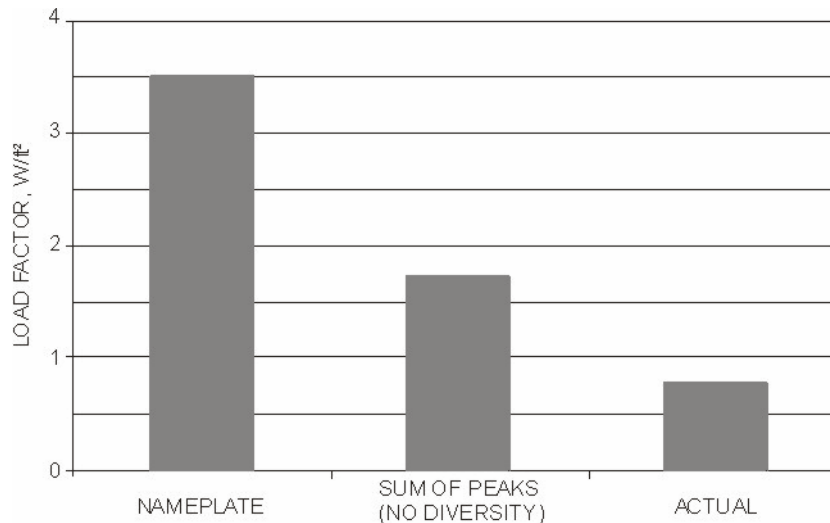

Figure 13. Office Equipment Load Factor Comparison – Wilkins, C.K. and N. McGaffin. ASHRAE Journal 1994 - Measuring computer equipment loads in office buildings

Although new commercial buildings have more office equipment installed, the equipment consumes less energy. For standard PCs and copiers, Energy Star compliant “idle” modes reduce energy usage when the equipment is unused for a period of time. Loads are also falling due to the increased use of LCD computer monitors rather than traditional CRT monitors, laptop computers rather than desktop computers, and shared network equipment such as printers.

The final report of ASHRAE Research Project 1093 reported that equipment power density (EPD) ranges from 0.18 to 0.66 W/ft² for office buildings based on measured data from eight buildings. Another study measured EPDs ranging from 0.4 to 1.1 W/ft² based on 44 typical office buildings with a total

floor area of 1.3 million ft².¹⁴ These data indicate that typical assumptions of 2 to 5 W/ft² are far off the mark. If no better data are available for EPD, the following tables provide EPD estimates for different building types from a few different sources.

Table 8. EPD – US DOE Buildings Energy Databook (All States) 2002

Building Type	EPD (W/ft ²)	
	Large (>=25,000 ft ²)	Small (<25,000 ft ²)
Office	1	1
Retail	0.4	0.5
	Pre-1980	Post-1980
School	0.8	0.8
Hospital	2.2	2.2

¹⁴ Paul Komor, ASHRAE Journal December 1997 paper “Space Cooling Demands From Office Plug Loads.”

Table 9. EPD – ASHRAE Standard 90.1 – 1989 Average Receptacle Power Densities (for compliance simulations)

Building Type	EPD (W/ft²)
Assembly	0.25
Office	0.75
Retail	0.25
Warehouse	0.10
School	0.50
Hotel or Motel	0.25
Restaurant	0.10
Health	1.00
Multi-family	0.75

Table 10. ASHRAE Handbook 2001 Fundamentals, Recommended EPD (note that these values assume CRT monitors; the use of LCD monitors would result in significantly lower values)

Load Density of Office	Load Factor W/ft²	Description
Light	0.5	Assumes 167 ft ² /workstation (6 workstations per 1000 ft ²) with computer and monitor at each plus printer and fax. Computer, monitor, and fax diversity 0.67, printer diversity 0.33.
Medium	1	Assumes 125 ft ² /workstation (8 workstations per 1000 ft ²) with computer and monitor at each plus printer and fax. Computer, monitor, and fax diversity 0.75, printer diversity 0.50.
Medium/Heavy	1.5	Assumes 100 ft ² /workstation (10 workstations per 1000 ft ²) with computer and monitor at each plus printer and fax. Computer, monitor, and fax diversity 0.75, printer diversity 0.50.
Heavy	2	Assumes 83 ft ² /workstation (12 workstations per 1000 ft ²) with computer and monitor at each plus printer and fax. Computer, monitor, and fax diversity 1.0, printer diversity 0.50.

As with lighting, ASHRAE research for plug loads has provided hourly diversity factors for equipment power. Figure 14 shows equipment schedules for office buildings of different sizes. The recommended diversity factors range from 70% to 95% for load calculations and range between 40% and 90% for purposes of energy simulations.

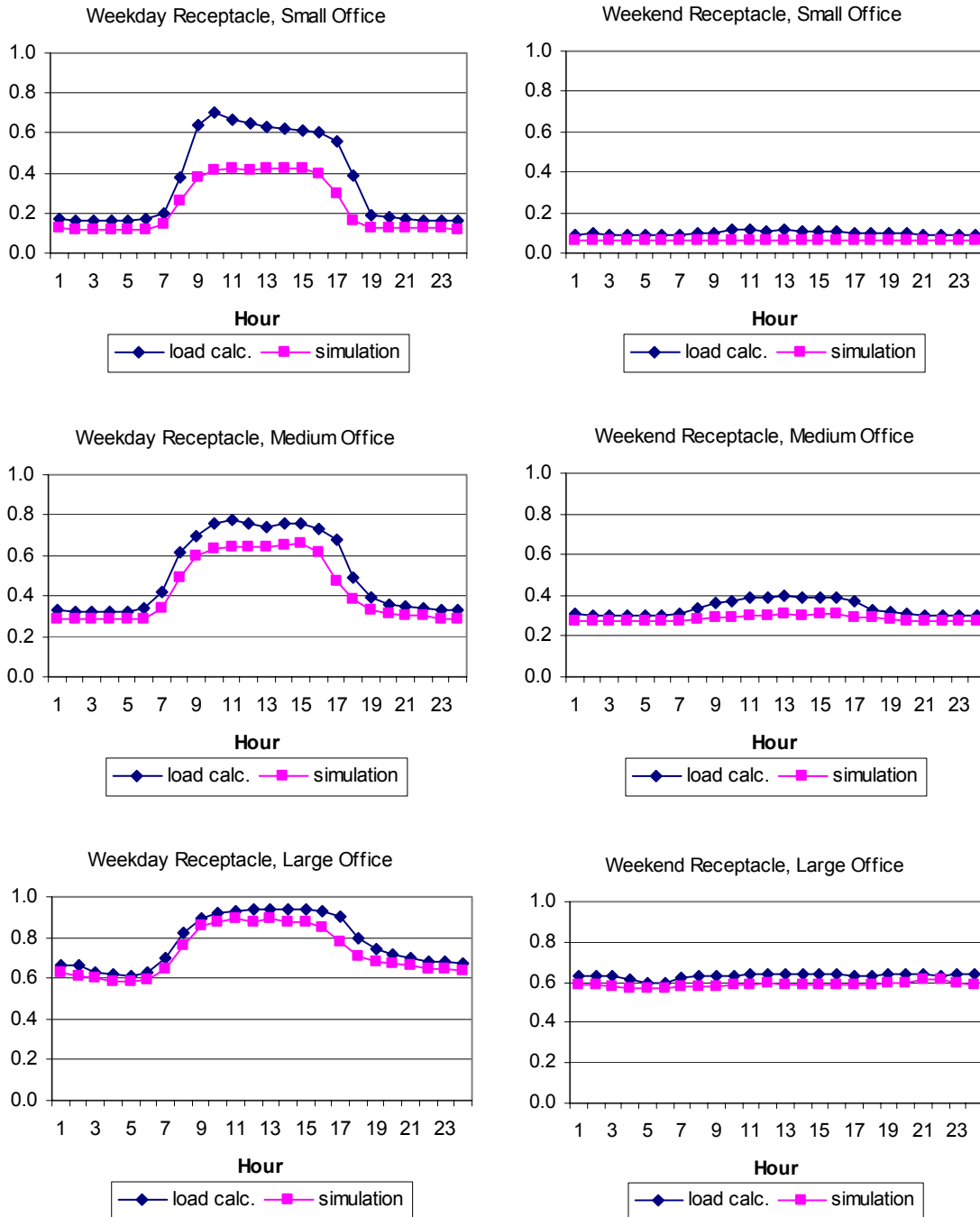

Figure 14. Measured Equipment Schedules (90th percentile for design load calculations and 50th percentile for energy simulations) for Small, Medium and Large Office Buildings – ASHRAE 1093-RP

Monitored Plug Loads

Measured plug loads (15 minute intervals from 9/14/2001 to 8/15/2002) for site 1 shows a peak of 0.67 W/ft² for the third floor office area. The profiles are shown for weekdays and weekends in Figure 15 and Figure 16.

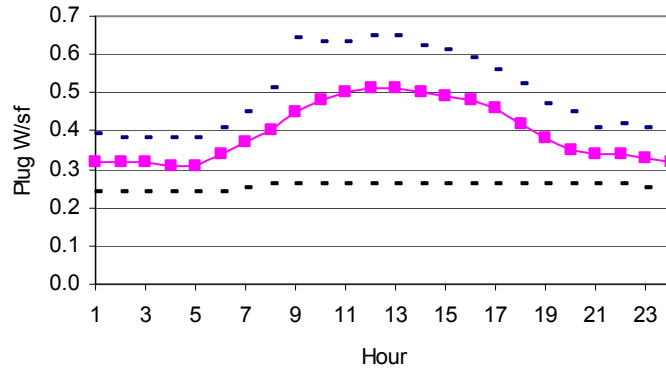

Figure 15. Measured Weekday Profile of Plug Power Density – Site 1 Office Area Showing Average (line) and Min/Max (dashes)

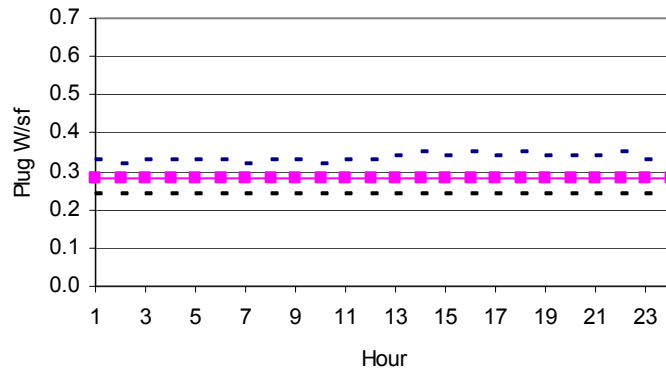
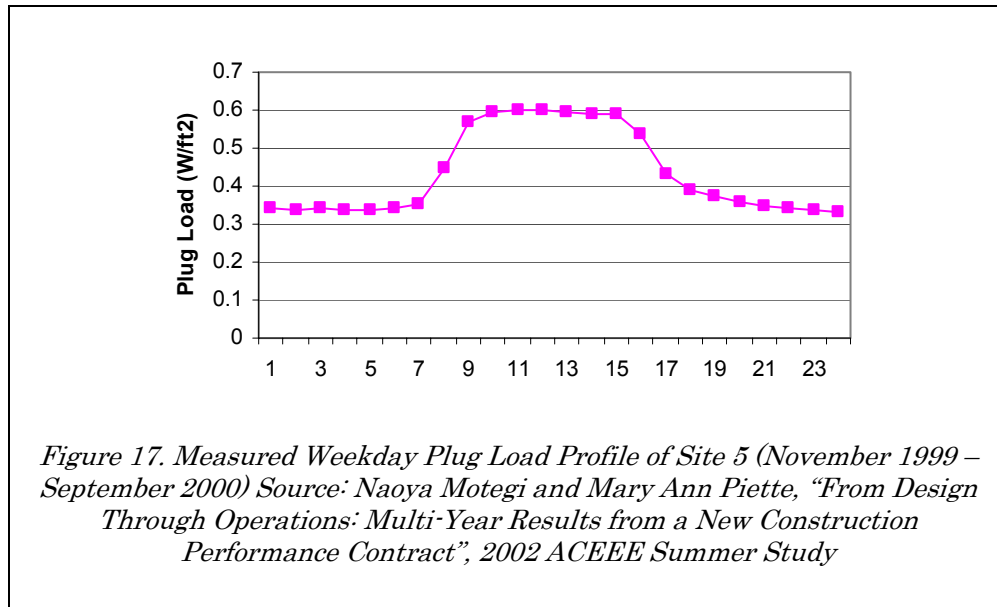

Figure 16. Measured Weekend Profile of Plug Power Density – Site 1 Office Area Showing Average (line) and Min/Max (dashes)

At Site 5, the daytime (9AM – 6PM) average plug load density is 0.57 W/ft², and 0.35 W/ft² in nighttime. The computer room has an average load of 2.4 W/ft², which causes the high nighttime load.



Occupant Loads

Occupant load assumptions can have a large impact on equipment sizing because it affects space loads as well as ventilation loads. For a typical office space, the sensible heat produced by occupants can be as high as 0.75 W/ft² (equal to 250 Btu/person at 100 ft²/person density), which is comparable in magnitude to lighting and plug loads. In a high-density space like a conference room, the occupant heat load can reach 5 W/ft² (at 15 ft²/person), which dominates the peak load calculation.

Due to the impact of occupant density assumptions, it is important to make an estimate of the likely numbers of occupants as well as peak numbers. With those two density estimates it is possible to ensure that the zone airflow can meet reasonable peak loads while the system can also operate efficiently under more likely conditions.

Simulation and Performance Targets

Simulation and performance targets can be useful tools to focus a design team and deliver whole building performance. The most commonly used simulation targets for new construction are building energy standards, which are referenced by programs such as LEED and Savings By Design. These programs seek to encourage integrated design by rewarding energy savings beyond minimum code requirements.

There are other approaches being used to set whole building performance targets. The University of California is using the past performance of existing buildings to set targets for a new campus (see sidebar). Other sources of potential targets include benchmarking programs such as Energy Star or the CalArch database (see sidebar).

A third approach is the E-Benchmark system from the New Buildings Institute, which takes a step beyond energy codes with a system of basic, prescriptive and “extra credit” design criteria. This approach utilizes a combination of simulation targets for the design phase and performance

targets for building operations. All of these approaches can be documented using the Design Intent Tool developed by Lawrence Berkeley National Laboratory (LBNL), available online (<http://ateam.lbl.gov/DesignIntent>).

Performance Targets at the University of California

The University of California took advantage of feedback from existing buildings in developing a new campus in Merced. Actual peak cooling loads for similar buildings from other campuses were used as a benchmark for design of new buildings. Design targets for total energy consumption and peak electric demand were also based on existing buildings. These targets, listed in Table 11, are based on savings compared to the existing campus average, increasing from 20% to 35% to 50% between 2004 and 2008.

It should be noted that the targets in this table were adjusted for anticipated space usage and climate. The reader is referred to the source paper for details on how this was done.

Table 11. UC Merced Building Energy Budgets for Classrooms, Office, and Library Buildings

	Maximum Power	Maximum Chilled Water	Annual Electricity	Maximum Thermal	Annual Thermal
	W/gft ²	Tons/kgft ²	kWh/gft ² /yr	Th/hr/kgft ²	Th/gft ² /yr
Opening in 2004	2.9	1.6	12	0.10	0.16
2005 – 2007	2.4	1.3	10	0.08	0.13
2008+	1.8	1.0	7.6	0.06	0.10

Source: Karl Brown, Setting Enhanced Performance Targets for a New University Campus: Benchmarks vs. Energy Standards as a Reference?, 2002 ACEEE Summer Study.

Energy Benchmarking

Tools are available to compare a building’s energy consumption to other similar facilities and can be helpful in setting performance targets. One such tool is CalArch, an Internet site allowing a user to plot energy consumption distributions for different building types and locations within California. See <http://poet.lbl.gov/cal-arch/> for California information or see <http://poet.lbl.gov/arch/> for U.S. national data.

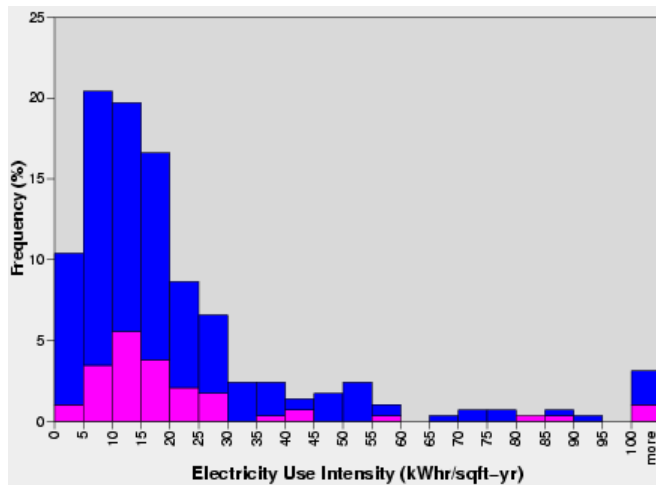

Figure 18. CalArch Benchmarking Tool Results, Office Building Electricity Use Intensity, PG&E and SCE Data (indicated by different colors) for Total of 236 Buildings

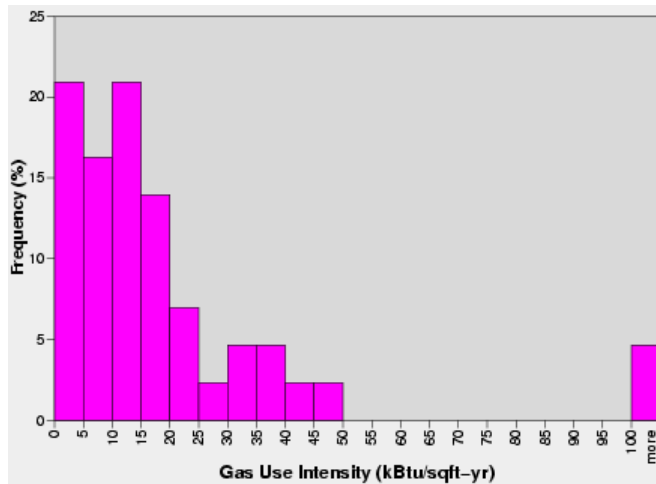
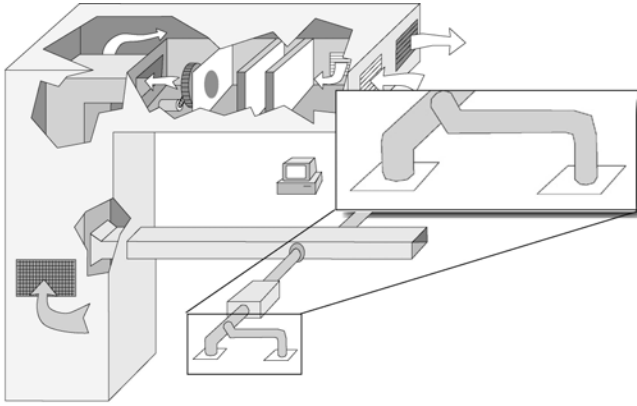

Figure 19. CalArch Benchmarking Tool Results, Office Building Gas Use Intensity, PG&E Data for Total of 43 Buildings

Zone Issues



- Thermal Comfort
- Zoning and Thermostats
- Demand Control Ventilation
- Occupancy Controls
- Window Switches
- Design of Conference Rooms

This section covers zone design issues such as thermal comfort, zoning, thermostats, application of CO₂ sensors for demand control ventilation, integration of occupancy controls, and issues affecting the design of conference rooms.

Thermal Comfort

The placement of thermostats is both crucial to comfort and can greatly affect the performance of an HVAC system. Numerous reports from the Building Owners and Managers Association (BOMA)¹⁵ and the University of California's Center for the Built Environment (CBE)¹⁶ document that second only to access to elevators, HVAC comfort is a top concern for tenants and often the reason that they change buildings. Since the thermostat is the HVAC systems proxy for occupant comfort, it is critical to make sure that it accurately represents the needs of the occupant.

Comfort is defined in ASHRAE Standard 55¹⁷ as a "condition of mind that expresses satisfaction with the thermal environment." It is a complex sensation that reflects a heat balance between the occupant and their environment, but tempered by personal preferences and by many environmental and social factors including job satisfaction. There are six primary factors that affect thermal comfort:

1. Metabolic rate.
2. Clothing insulation.

¹⁵ See for instance Building Owners and Managers Association (BOMA) International and ULI—the Urban Land Institute. *What Office Tenants Want: 1999 BOMA/ULI Office Tenant Survey Report*. Washington, D.C., BOMA International and ULI—the Urban Land Institute, 1999. Results of a survey of 1800 office building tenants across the U.S and Canada. Survey asks respondents to rank the importance of and their satisfaction with key building features, amenities and services.

¹⁶ See the CBE website <http://www.cbe.berkeley.edu/RESEARCH/briefs-feedback.htm>.

¹⁷ ASHRAE Standard 55-1992, *Thermal Environmental Conditions for Human Occupancy*

3. Air temperature.
4. Radiant temperature
5. Air speed.
6. Humidity.

With most commercial HVAC systems, space temperature is the only one of these six factors that is directly controlled, typically with a wall-mounted thermostat. Humidity is indirectly limited on the high side as part of the cooling process, and can be limited on the low side with humidifiers. For the mild, dry climates of California, humidity is not a major factor in comfort in most commercial buildings.

While temperature and humidity are relatively constant throughout most conditioned spaces, the radiant temperature may vary significantly from surface to surface. This variation, called radiant asymmetry, is seldom directly controlled by the HVAC system¹⁸. Radiant asymmetry can be significant in perimeter offices. An occupant in a west-facing zone with floor to ceiling single pane glass may be hot in the summer and cold in the winter almost regardless of the space temperature because of the asymmetric radiant environment. Luckily, this is less of an issue since Title 24 now requires double pane low-e glass in all climates. However when dealing with a highly asymmetric radiant environment, the best strategies, in order of preference, are 1) provide better glazing, less glazing and/or external shading; 2) use a mean radiant temperature sensor to reset the zone thermostat setpoint.

Zoning and Thermostats

Zoning of mechanical systems is determined through a delicate balance between first cost and comfort. Ideally one zone would be provided per room or workspace, but the cost is prohibitive for most building owners. The cost/comfort balance typically results in zones of 500 ft² to 1,200 ft², encompassing five to 10 workstations per zone. Given that zones cost between \$2,000 and \$3,500 per installed VAV box with controls, it is hard to convince an owner to add an additional \$3/ft² to \$6/ft² to the mechanical system costs to increase the number of zones. The unfortunate reality is that personal space heaters and fans are often brought in by tenants to fix zoning problems at a tremendous cost to the owner in energy bills.

Before ganging rooms or workstations together into a single zone, make sure they have similar load characteristics. Perimeter zones should only group offices with the same orientation of glass, and interior spaces should not mix enclosed conference rooms or equipment rooms with general office space.

Lower cost options to subzoning include the use of self-powered VAV diffusers and the addition of multiple temperature sensors in a zone. VAV diffusers can individually modulate the room airflow to provide some level of subzoning. They cost approximately \$200 to \$250 per diffuser more than a

¹⁸ It can be controlled using window shades (internal or external) or through thermostat setpoint adjustment using a radiant globe sensor. Typically, window shades are provided on the interior of windows and are manually operated. Radiant space sensors are expensive and rarely applied in the field. Another option is radiant heating and/or cooling systems.

conventional ceiling diffuser. For a space with one diffuser, this might be a reasonable option for subzoning. Multiple temperature sensors can be used with a signal selector to allow the room farthest off setpoint to control the box. Most VAV DDC zone controllers have at least one spare analog input which could be used for additional temperature sensors. The cost of additional sensors using spare points will be on the order of \$150. If additional sensors require additional DDC zone controllers, the cost can increase to as much as \$1,000/point. If the zone control system is based on LonWorks technology, it is possible to tie sensors directly to the network at approximately \$200/point.

Thermostats should be located on the plans and specified to be mounted at 3' to 4' above the finished floor with gasketing on the control wiring to prevent bias of sensors from air leaking from the wall behind the thermostat. Avoid mounting thermostats on exterior walls where exterior heat gains and losses and infiltration can result in false readings. If mounting thermostats on exterior walls is unavoidable, specify rigid insulation between the thermostat backplate and the wall. When placing thermostats in the space, review the furniture plans and avoid locations near heat producing equipment like coffee pots, computers, or copy machines. Avoid locations that can receive direct solar radiation and require a shield on the thermostat if this cannot be arranged. A poorly located thermostat guarantees comfort complaints (unhappy customer) and excessive energy bills (a really unhappy customer).

Demand Control Ventilation (DCV)

Title 24 currently requires demand ventilation controls in very dense occupancies (10 ft²/person or less). In the 2005 version of Title 24, demand ventilation controls using CO₂ sensors are required on all single zone systems serving dense occupancies (less than or equal to 40 ft²/person) that have an airside economizer. This requirement was based on a detailed life-cycle cost analysis¹⁹. Although not required, almost any VAV reheat zone serving an expected occupant load denser than about 40 ft²/person can potentially benefit from CO₂ control. If a space has a CO₂ sensor, the minimum ventilation setpoint is set to the Table 1-F²⁰ value from Title 24 (0.15 CFM/ft² for most spaces). The outdoor air rate is then modulated upward from this lower limit as required to maintain the CO₂ concentration at 1,000 ppm.²¹

With multiple zone systems, the zone CO₂ controls should first increase the airflow rate at the space then increase the outdoor air rate at the air handler as described in the following sequence:

At the zone: during Occupied Mode, a proportional-only control loop shall maintain CO₂ concentration at 1,000 ppm. The output of this loop (0 to 100%) shall be mapped as follows: The loop output from 0 to 50% shall reset the minimum airflow setpoint to the zone from the design minimum (see "Minimum airflow setpoints") up to the maximum cooling airflow

¹⁹ For detailed life-cycle cost study refer to the report: Part 1, Measure Analysis and Life-Cycle Cost, 2005 California Building Energy Efficiency Standards. California Energy Commission. P400-02-011. April 2002.

²⁰ This table is now Table 121-A in the 2005 Standards.

²¹ Although a setting of 1,100 ppm of CO₂ or 700 ppm above ambient is closer to 15 cfm/person at typical metabolic rates of 1.2 met, the setpoint was reduced to 1,000 ppm in response to concerns raised by CalOSHA. This is also the historical setpoint established in ASHRAE Standard 1989 before it was updated in 1999.

setpoint. The loop output from 50% to 100% will be used at the system level to reset outdoor air minimum.

At the Air handler: The minimum outdoor air setpoint shall be reset based on the highest zone CO₂ loop signal from absolute minimum at 50% signal to design minimum at 100% signal. Design minimum is the sum of the code minimums as if there were no CO₂ control. Absolute minimum is the sum of the following:

1. For zones with CO₂ controls: Table 1-F²² value from Title 24 (e.g., 0.15 cfm/ft²) times the occupied area.
2. For zones without CO₂ controls: the design minimum outdoor air rate which is the greater of the Table 1-F value from Title 24 (e.g., 0.15 cfm/ft²) times the occupied area and 15 CFM per person times the design number of occupants. See Table 6.

The 2005 Title 24 requirements also include the following requirements where CO₂ sensors are used: One CO₂ sensor must be provided for each room that has a design occupancy of less than 40 ft²/person. The sensors must be mounted between one and six feet above finished floor, which is the occupant breathing zone. (Locating sensors in return air ducts or plenums is not allowed since the sensor reading will be skewed by outdoor air leakage into the duct, mixing with return air from other zones, and possible short-cycling of supply air from diffusers into return air inlets. See sidebar.) CO₂ sensors must have an accuracy of no less than 75ppm and be certified from the manufacturer to require calibration no more frequently than every five years.

²² This table is now Table 121-A in the 2005 Standards.

DCV Data

Site 4, a Federal courthouse, has a 31,000-ft² floor plate with ~23% of the area dedicated to three courtrooms and/or meeting rooms on a typical floor. The HVAC system was designed with a fixed minimum outdoor air damper sized for ~0.2 cfm/ft². The designer put in a CO₂ sensor in the return that would reset the economizer if the CO₂ levels exceeded 1,100 ppm in the return air. As part of our project, the team installed new calibrated CO₂ sensors in the return, the outdoor air intake, and in three high occupant density spaces (two meeting rooms and a courtroom).

During a three-week period of monitoring at this site, we overrode the economizer, forcing the outdoor air flow to its minimum setpoint, to examine the space CO₂ levels and ventilation system design. For the entire period, the courtroom and meeting rooms were always below 1,100 ppm CO₂ even with the economizer closed. During that time there were several days with the meeting rooms overflowing with people. Title 24 requires a minimum ventilation rate of about 0.19 cfm/ft² (80 ft²/person) for courtrooms and approximately 1.0 cfm/ft² (15 ft²/person) for the meeting rooms. With CO₂ controls this could be reduced to 0.15 cfm/ft² minimum with modulation upward based on zone demand.

This study yields several interesting results:

1. There is enough dilution in this building to handle the peak courtroom and meeting room occupant densities with an outdoor air intake of only 0.2 cfm/ft².
2. The VAV box minimums being set at 50% helped the space dilution but at the cost of large amounts of fan and reheat energy.
3. With demand ventilation (CO₂) controls, the minimum outdoor air dampers can be rebalanced to 0.15 cfm/ft². This is approximately a 25% reduction in the present ventilation load.
4. The CO₂ sensor in the return was useless. It measured the building's diluted concentrations of CO₂, which did not track the peaks in the individual densely occupied spaces. Figure 20 shows data from February 7th, 2003, the highest space levels of CO₂ in the three-week monitoring period. The return air CO₂ concentration is as low as half the peak concentration. The 2005 Title 24 explicitly requires sensors to be located at the breathing level in each space for this reason.

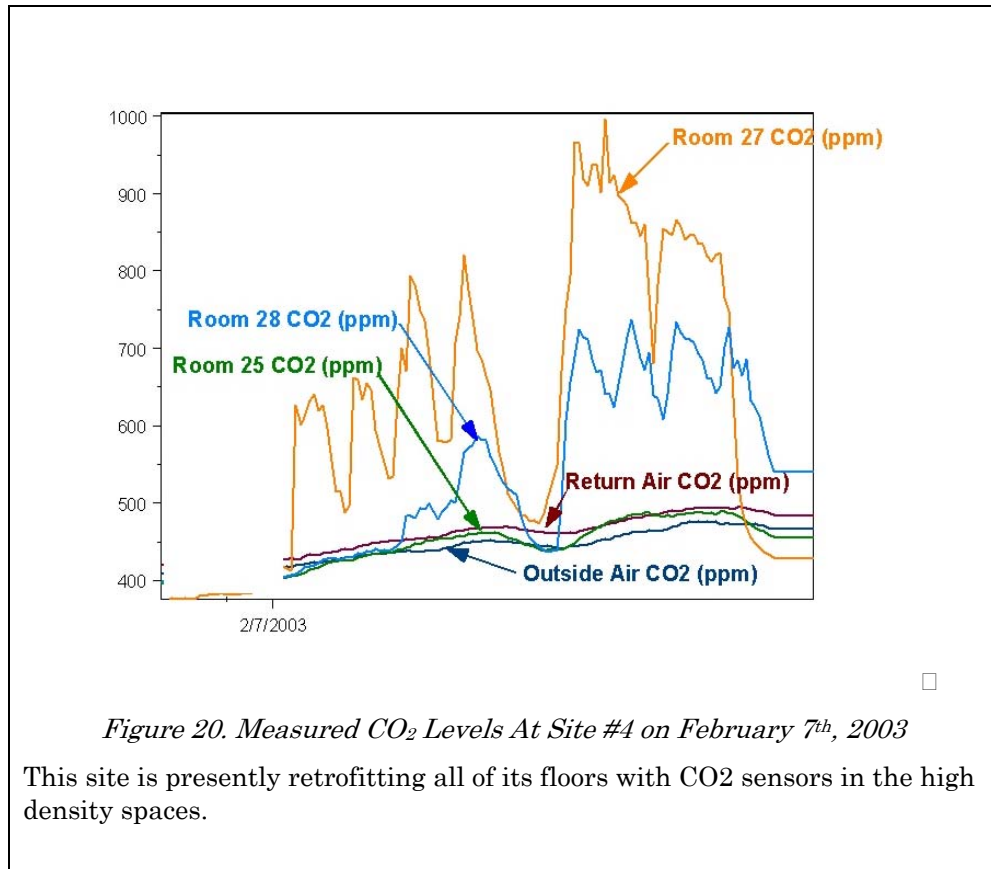

Occupancy Controls

Occupant sensors have come of age. Due to their prevalence in lighting systems, they are stable in design and reliability and relatively inexpensive. In addition to controlling the lighting, they can be used to control the occupancy status of individual zones. By setting back temperature and airflow setpoints when the space served is unoccupied, central fan airflow is reduced and zone reheat is minimized. Where zones are provided with sub-zone sensors, the occupant sensor can be used to eliminate the sub-zone sensor reading from the signal selection controlling the VAV box.

Unfortunately Title 24 requires that zones provide the code-required minimum outdoor airflow rate when spaces are “usually occupied.” To comply with this, VAV box minimum airflow setpoints cannot be set to zero in response to an occupant sensor. The box minimum can be reset to a minimum setpoint equal to the Table 1-F value from Title 24 (e.g., 0.15 cfm/ft²) times the occupied area, and the temperature setpoints can be widened. To allow spaces to return to comfortable temperatures fairly quickly after they are reoccupied, the setpoints should not be set more than a few degrees off of occupied setpoints.

Window Switches

Where VAV boxes serve rooms with operable windows, consider the use of position indicating switches on the windows interlocked with the VAV box

controls. This interlock is similar to the one described under occupant sensors above, but in this case, when the switch indicates the window is open, the VAV box can be shut off to a zero airflow minimum (since ventilation is provided by the windows) and setpoints can be extended even further from occupied setpoints (to ensure energy is not wasted if windows are left open or opened in extreme weather). Position switches are typically reed switches that operate with a magnet to indicate the status of a window. They are used extensively in security systems. The reed switch is typically only a few dollars in cost, the largest cost of the reed switches is the labor to mount and wire them to the control system. Window manufacturers will often mount and wire them as part of the window assembly but this requires coordination with the architect or general contractor who specifies the window assembly.

Design of Conference Rooms

Conference rooms, because of their variable occupancy and high occupant design densities, present a challenge to the designer. Minimum ventilation rates at the design occupancy represent a high percentage of the overall supply air rate, particularly for interior conference rooms. At low occupancies and low loads, design minimum ventilation rates may be above the required supply air flow, potentially causing the room to be overcooled. Maintaining minimum rates and temperature control simultaneously can be done using one of the following options:

1. Set the minimum airflow setpoint on the zone VAV box to the design occupancy ventilation rate. For interior conference rooms, this minimum rate will equate to 75% to 100% of the design cooling maximum supply rate. Clearly, this option wastes fan energy as well as cooling and heating energy through reheat. It can also require the heating system to operate even in warm weather to prevent over-cooling conference rooms that are only partially occupied. If the minimum ventilation rate represents more than about 40% of the design cooling supply rate, this option is not recommended. This typically limits the application to perimeter zones with high solar loads.
2. Use a VAV box with a high minimum as above, but integrate it with the lighting system occupant sensor to reduce the box minimum to the Title 24 Table 1-F level (e.g. 0.15 cfm/ft²) during unoccupied times. This option is better than option 1 above but it still wastes energy when the conference room is lightly loaded (less than the design number of occupants are in the room).
3. Use a VAV box with a CO₂ sensor to reset the zone minimum between the Title 24 Table 1-F level (e.g. 0.15 cfm/ft²) and the design ventilation minimum. This option uses less mechanical system energy than the occupant sensor solution because it is effective when the space is partially occupied as well as unoccupied.
4. Use a series fan-powered VAV box with a zero minimum airflow setpoint. Because Title 24 allows transfer air to be used to meet ventilation requirements (see Code Ventilation Requirements), minimum ventilation can be provided by the series-fan supplying only plenum air, eliminating central air and reheat. This is the simplest option from a controls perspective and it is one of the most efficient.

VAV Box Selection

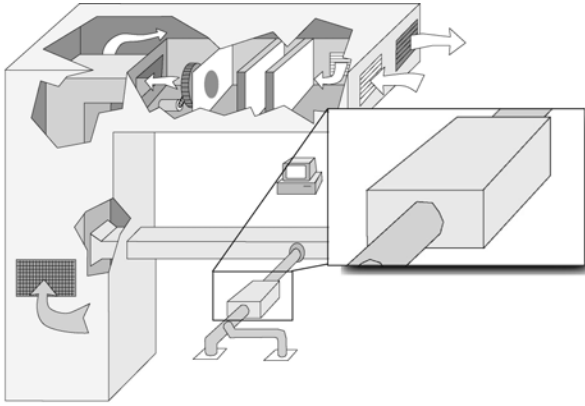

- VAV Box Selection Summary
- VAV Reheat Box Control
- Minimum Volume Setpoints
- Sizing VAV Reheat Boxes
- Other Box Types
- Other Issues

Selecting and controlling VAV reheat boxes has a significant impact on HVAC energy use and comfort control. The larger a VAV box is, the lower its pressure drop, and in turn, the lower the fan energy. However, the larger VAV box will require a higher minimum airflow setpoint, which in turn will increase the amount of reheat and fan energy. In addition to these energy trade-offs, smaller boxes also generate more noise than larger boxes at the same airflow but they can provide more stable control because they have a greater damper “authority” or α -value (see ASHRAE Handbook of Fundamentals Chapter 15 for details). However, within the selection range discussed below, damper authority is seldom a significant selection consideration.

This section gives guidance on selecting and controlling VAV boxes with hot water reheat. Other types of VAV boxes (e.g., electric reheat, dual duct, fan-powered) are covered in sections that follow, but in less detail. This document only applies to VAV boxes with pressure independent controls²³.

VAV Box Selection Summary

The discussion that follows can be summarized as follows, with details in later sections:

1. Use a “dual maximum” control logic, which allows for a very low minimum airflow rate during no- and low-load periods (see the section below, “Recommended Approach (Dual Maximum)”).
2. Set the minimum airflow setpoint to the larger of the lowest controllable airflow setpoint allowed by the box controller (see the section below, “Determining the Box Minimum Airflow”) and the minimum ventilation requirement (see the section below, “Minimum airflow setpoints”).

²³ Pressure independent controls include two “cascading” (also called master and sub-master) controllers, one controlling space temperature and one controlling supply airflow rate. The output of the space temperature controller resets the setpoint of the airflow controller within the maximum and minimum airflow setpoints.

- For all except very noise sensitive applications, select VAV boxes for a total (static plus velocity) pressure drop of 0.5" H₂O. For most applications, this provides the optimum energy balance (see the section below, "Sizing VAV Reheat Boxes").

VAV Reheat Box Control

Common Practice (Single Maximum)

Common practice in VAV box control is to use the control logic depicted in Figure 21. In cooling, airflow to the zone is modulated between a minimum airflow setpoint and the design cooling maximum airflow setpoint based on the space cooling demand. In heating, the airflow is fixed at the minimum rate and only the reheat source (hot water or electric heater) is modulated. The VAV box minimum airflow setpoint is kept relatively high, typically between 30% and 50% of the cooling maximum airflow setpoint (see Code Limitations").

Advocates of this approach argue that it:

- Insures high ventilation rates.
- Provides adequate space heating capacity.
- Prevents short circuiting due to stratification in heating mode by keeping supply air temperature relatively low (e.g., less than 90°F).
- Prevents "dumping" by keeping air outlet velocities from getting too low.
- Works for all box direct digital controller manufacturers and control types (i.e., pneumatic, analog electronic or digital).

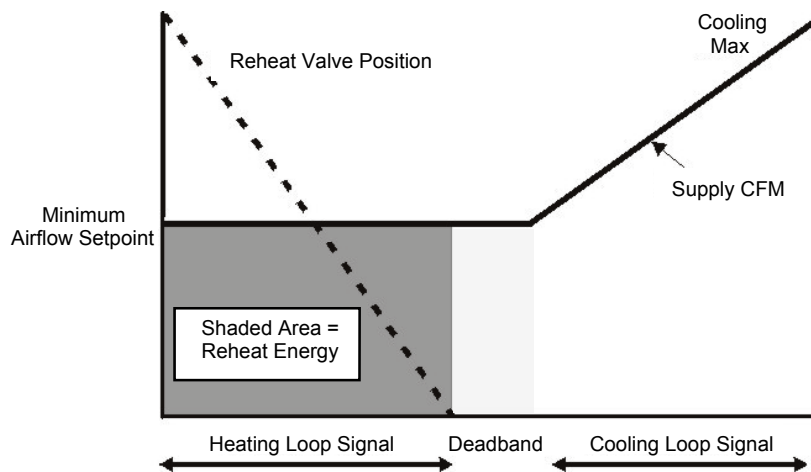

Figure 21. VAV Hot Water Reheat Box Control - Single Maximum

Recommended Approach (Dual Maximum)

A more energy efficient VAV box control logic is the “dual maximum” strategy depicted in Figure 22. In addition to a minimum airflow setpoint and a cooling maximum airflow setpoint, there is also a heating maximum airflow setpoint; hence the name “dual maximum”. The heating maximum airflow setpoint is generally equal to the minimum airflow setpoint in the conventional approach described above; in both cases they would be determined based on meeting heating load requirements. That allows the minimum airflow setpoint to be much lower (see “Minimum airflow setpoints”).

The control logic of the dual maximum approach is described by the following sequence of operation:

1. When the zone is in the cooling mode, the cooling loop output is mapped to the airflow setpoint from the cooling maximum to the minimum airflow setpoints. The hot water valve is closed.
2. When the zone is in the deadband mode, the airflow setpoint shall be the minimum airflow setpoint. The hot water valve is closed.
3. When the zone is in the heating mode, the heating loop shall maintain space temperature at the heating setpoint as follows:
 - a. From 0%-50% loop signal, the heating loop output shall reset the discharge temperature from supply air temperature setpoint (e.g., 55°F) to 90°F. Note the upper temperature is limited to prevent stratification during heating.
 - b. From 50%-100% loop signal, the heating loop output shall reset the zone airflow setpoint from the minimum airflow setpoint to the maximum heating airflow setpoint. The supply air discharge temperature remains at 90°F.
4. The hot water valve shall be modulated using a PI control loop to maintain the discharge temperature at setpoint. Note that directly controlling the hot water valve from the zone temperature PI loop is not acceptable since it will not allow supply air temperature to be under control and limited in temperature to prevent stratification.
5. The VAV damper shall be modulated to maintain the measured airflow at setpoint.

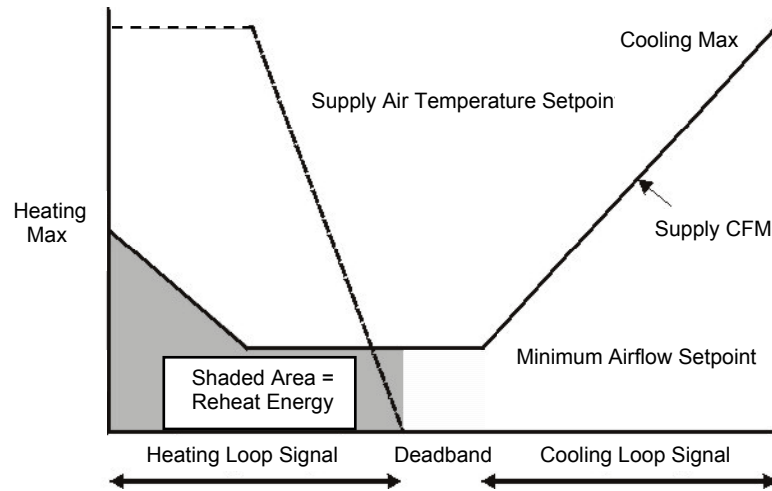

Figure 22. VAV Hot Water Reheat Box – Dual Maximum

While the hatched area (which is proportional to the magnitude of the reheat energy) in

Figure 21 and Figure 22 may not appear to be very different, the difference can be quite significant on an annual basis since VAV boxes typically spend much of their time in the deadband and mild heating modes. For example, suppose a zone has a cooling design maximum of 1.5 CFM/ft². With a single maximum VAV box control and a 30% minimum, 0.45 CFM/ft² would be supplied in deadband. With a dual maximum VAV box control and a properly selected minimum (see “Minimum airflow setpoints”), this rate could drop to about 0.15 CFM/ft². In this case, the single maximum results in three times more airflow and three times more reheat energy than the dual maximum approach in all but the coldest weather.

The arguments supporting the dual maximum approach include:

- It allows for much lower airflow rates in the deadband and first stage of heating while still maintaining code ventilation requirements. This reduces both reheat energy and fan energy.
- By reducing the deadband minimum airflow rate, spaces are not over-cooled when there is no cooling load and “pushed” into the heating mode.

- By controlling the reheat valve to maintain discharge supply temperature rather than space temperature, supply air temperature can be limited so that stratification and short circuiting of supply to return does not occur. This improves heating performance and ventilation effectiveness (see Figure 22). It also keeps the HW valve under control at all times, even during transients such as warm-up. With two-way valves, this makes the system completely self-balancing, obviating the need for balancing valves and associated labor. (See also Taylor, S.T. Balancing Variable Flow Hydronic Systems, "ASHRAE Journal, October 2002.)²⁴

Disadvantages include:

- Only a few direct digital control manufacturers that have “burned-in” programming in their controllers (often called “preprogrammed” “configurable” controllers) offer dual maximum logic as a standard option. However, there are many fully programmable zone controllers on the market and all of them can be programmed to use this logic.
- There is a greater airflow turndown and potential risk of dumping and poor air distribution with improperly selected diffusers. See “Minimum airflow setpoints”.
- While ventilation codes are met, airflow rates are reduced which results in higher (although acceptable) concentrations of indoor contaminants.

Minimum airflow setpoints

Code Limitations

Title 24 places limits on both the lowest and highest allowable VAV box minimum airflow setpoints.

The lowest allowable setpoints are those required to meet ventilation requirements (see Code Ventilation Requirements). Note that since Title 24 allows air transferred or returned from other ventilated spaces to be used for ventilation, the minimum airflow setpoint need not be adjusted for the fraction of “fresh” air that is in the supply air. In other words, if the minimum ventilation rate is 0.15 cfm/ft², then the minimum airflow setpoint may be set to that value even if the supply air is not 100% outdoor air, provided the design minimum outdoor air at the air handler is delivered to some other spaces served by the system (again, see Code Ventilation Requirements).

Title 24 Section 144 limits the highest allowable minimum airflow setpoints in order to minimize reheat energy. In Section 144, the minimum setpoint is mandated to be no greater than the largest of the following:

1. 30% of the peak supply volume; or

²⁴ In a traditional control sequence, the maximum call for heating would open up the heating valve fully. During warm-up, the coils closest to the pump would likely take more than their design share of the hot water flow, partially starving the coils furthest from the pump. By controlling leaving air temperature instead of valve position each reheat coil is limited to its design flow.

2. The minimum required to meet the ventilation requirements of Section 121; or
3. 0.4 cubic feet per minute (cfm) per square foot of conditioned floor area of the zone; or
4. 300 cfm.

In common practice, VAV box minimums are set much higher than even this code limit, and much higher than they need to be. In the buildings surveyed for this document, the box minimums ranged between 30% and 50% of design airflow (see Table 12). Unfortunately, this common practice significantly increases reheat fan, and cooling energy usage.

Table 12. VAV Box Minimums from Five Measured Sites

Site	Average	Type
#1	No data	
#2	28% +/- 19%	VAV reheat with dual maximums
#3	30%	VAV interior with parallel fan-powered boxes with electric reheat
#4	50%	VAV reheat with single maximum
#5	40%	VAV reheat with single maximum

With the dual maximum strategy (see “Recommended Approach (Dual Maximum)”), the minimum airflow setpoint need not be based on peak heating requirements. To minimize energy usage while still complying with Title 24 ventilation requirements, the minimum airflow setpoint should be set to the greater of:

1. The minimum airflow at which the box can stably control the flow (see “Determining the Box Minimum Airflow”); and
2. Ventilation requirement (see “Code Ventilation Requirements”).

Although the dual maximum strategy saves energy, meets the Title 24 Section 144 requirements and maintains code required ventilation, some engineers remain concerned about the following issues:

- Minimum air movement and stuffiness
- Diffuser dumping and poor distribution problems
- Air change effectiveness

These concerns are largely anecdotal and unsupported by research, as shown in the following paragraphs.

Minimum Air Movement and Stuffiness

ASHRAE Standard 55-1992 states clearly that “there is no minimum air speed necessary for thermal comfort” if the other factors that affect comfort (drybulb temperature, humidity, mean radiant temperature, radiant and thermal asymmetry, clothing level, activity level, etc.) are within comfort ranges. People routinely experience this at home: they can be perfectly comfortable with no air movement (windows closed, furnace and AC unit off) yet for some reason many HVAC engineers insist that these same people need air movement at work. They use this to justify higher minimum airflow setpoints (e.g., 0.4 CFM/ft², the maximum allowed by Title 24).

There are virtually no studies that support this perception, however. Even if perceptible air motion was associated with comfort, higher airflow rates out of a given diffuser are unlikely to increase perceived air velocities in the occupied region simply because the velocities are below perceptible levels even at full airflow by design – that is, after all, what diffusers are designed and selected to do.

Simply put, studies to date show fairly conclusively that complaints of “stuffiness” and poor air motion are not due to lack of air movement but instead indicate that spaces are too warm. Lower the thermostat (e.g., to <72°F) and the complaints almost always go away.

Dumping and Poor Distribution

Another concern when using a relatively low box minimum is degradation of diffuser performance. There are two potential issues with low minimums: stratification and short-circuiting in heating mode (see discussion of air change effectiveness) and dumping in cooling mode. A diffuser designed for good mixing at design cooling conditions may “dump” at low flow. Dumping means that the air leaving the diffuser does not have sufficient velocity to hug the ceiling (the so-called Coanda effect) and mix with the room air before reaching the occupied portion of the room. Instead, a jet of cold air descends into the occupied space creating draft and cold temperatures which in turn creates discomfort. The industry quantifies diffuser performance with the Air Diffusion Performance Index (ADPI). Maintaining nearly uniform temperatures and low air velocities in a space results in an ADPI of 100. An ADPI of 70 to 80 is considered acceptable. The ASHRAE Handbook of Fundamentals gives ranges of T_{50}/L for various diffuser types that result in various ADPI goals. L is the characteristic room length (e.g., distance from the outlet to the wall or mid-plane between outlets) and T_{50} is the 50 FPM throw, the distance from the outlet at which the supply air velocity drops to 50 feet per minute. For a perforated ceiling diffuser, the Handbook indicates that acceptable ADPI will result when T_{50}/L ranges from 1.0 to 3.4. This basically means that best turndown possible while still maintaining an acceptable ADPI is $1/3.4 = 30\%$ turndown. Other types of diffusers have greater turndown. A light troffer diffuser, for example, can turndown almost to zero and still maintain acceptable ADPI.

Note that ADPI tests are always done under a cooling load. For all diffuser types, the lower the load, the greater the turn-down percentage while still maintaining acceptable ADPI. The lowest load catalogued in the ASHRAE Handbook of Fundamentals is 20 Btu/h/ft², equal to roughly 1 cfm/ft² which is a fairly high load, well above that required for interior zones and even well shaded or north-facing perimeter zones. To achieve good air distribution when the load is substantial, maintaining diffuser throw is important. However, when the low airflow rates occur with the dual maximum strategy, loads are by definition very low or zero. Under these conditions, acceptable ADPI may occur with even zero airflow. Again, consider experiences in the home: temperatures around the home can be very uniform with no air circulation when AC and heating equipment is off at low or no loads.

Concern about dumping may be overblown (no pun intended). There are many buildings operating comfortably with lower than 30% airflow minimums. Researchers at UC Berkeley and Lawrence Berkeley National Laboratory performed several laboratory experiments with two types of perforated diffusers and two types of linear slot diffusers (Fisk, 1997;

Bauman, 1995). They measured air change effectiveness (using tracer gas) and thermal comfort (using thermal mannequins) in heating and cooling mode and at various flow rates (100%, 50%, and 25% turndown). They also measured throw and space temperature and velocity distribution from which they calculated ADPI. They found that in cooling mode ADPI depended more on the diffuser type than the flow rate. For example, the least expensive perforated diffuser had an ADPI of 81 at 25% flow. They also found that in nearly all cooling tests thermal comfort was within the acceptable range and air change effectiveness was consistently at or above 1.0.

Air Change Effectiveness

Air change effectiveness measures the ability of an air distribution system to deliver ventilation air to the occupied (breathing) zone of a space. A value of 1.0 indicates perfect mixing; the concentration of pollutants is nearly uniform. A value under 1.0 implies some short-circuiting of supply air to the return. Values greater than 1.0 are possible with displacement ventilation systems where the concentration of pollutants in the breathing zone is less than that at the return. Studies have shown that air change effectiveness is primarily a function of supply air temperature, not diffuser design or airflow rates. Measurements by all major research to-date (e.g. Persily and Dols 1991, Persily 1992, Offerman and Int-Hout, 1989) indicate that air change effectiveness is around 1.0 for virtually all ceiling supply/return applications when supply air temperature is lower than room temperature. Bauman et al 1993 concluded that “a ceiling mounted supply and return air distribution system supplying air over the range 0.2 to 1.0 cfm/ft² [1.0 to 5.0 L/s·m²] was able to provide uniform ventilation rates into partitioned work stations. The range of tested supply volumes represented rates that were below and above the [diffuser] manufacturer’s minimum levels for acceptable performance.” Fisk et al 1995 concluded that “when the supply air was cooled, the [air change effectiveness] ranged from 0.99 to 1.15, adding to existing evidence that short-circuiting is rarely a problem when the building is being cooled.” This study was based on air flow rates ranging from 0.2 to 0.5 cfm/ft² (1.0 to 2.5 L/s·m²) using linear slot diffusers as well as two types of inexpensive perforated diffusers.

These studies indicate that low air change effectiveness is only an issue in heating mode; the higher the supply air temperature above the space temperature, the lower the air change effectiveness. This suggests that the low minimum airflow setpoints we propose will result in lower air change effectiveness for a given heating load since the supply air temperature must be higher. But air change effectiveness will stay around 1.0 if the supply air temperature is no higher than about 85°F²⁵. With the dual maximum approach with the hot water valve controlled to maintain supply air temperature (rather than directly from room temperature), the supply air temperature can be limited below 85°F, thus mitigating or even eliminating this problem. Note that some zones may require higher supply air temperatures to meet peak heating load requirements. If so, the problem will be the same for both the dual maximum and conventional single maximum approach since at peak heating (the far left side of the control diagram), both have the same airflow setpoint. For these spaces, fan-powered mixing boxes can be used to increase heating airflow rates while at the same time limiting

²⁵ See ASHRAE Standard 62, Addendum 62n, Table 6.2. 85°F limit assumes 70°F space temperature (15°F ΔT).

supply air temperatures below 85°F and maintaining low minimum airflow setpoints to minimize reheat losses.

Engineers and operators who may not be convinced by these arguments are encouraged to experiment with low minimums to see for themselves if problems occur. Minimum airflow setpoints are easily adjusted up to higher levels if comfort complaints do arise. There are many buildings in operation with this form of control and high degrees of perceived comfort.

Determining the Box Minimum Airflow

As mentioned previously one limitation on the minimum for the VAV box is the controllability of the box. This section discusses how the designer can determine this value.

VAV box manufacturers typically list a minimum recommended airflow setpoint for each box size and for each standard control options (e.g. pneumatic, analog electronic, and digital). However, the actual controllable minimum setpoint is usually much lower than the box manufacturer's scheduled minimum when modern digital controls are used.

The controllable minimum is a function of the design of the flow probe (amplification and accuracy) and the digital conversion of the flow signal at the controller (precision). These issues are elaborated in the following paragraphs:

The flow probe is installed in the VAV box and provides an air pressure signal that is proportional to the velocity pressure of the airflow through the box. Flow probes, which are typically manufactured by and factory installed in the VAV box by the box manufacturer, are designed to provide accurate signals even when inlet conditions are not ideal (e.g. an elbow close to the inlet) and to amplify the velocity pressure signal to improve low airflow measurement. The amplification factor varies significantly by VAV box manufacturer and box size. The greater the amplification, the lower the controllable minimum. The VAV box manufacturer must balance this benefit with other design goals such as minimizing cost, pressure drop, and noise.

The accuracy of the box controller in converting the velocity pressure signal from the probe to a control signal. To make this conversion, digital controls include a transducer to convert the velocity pressure signal from the probe to an analog electronic signal (typically 4-20 mA or 0-10 Vdc) and an analog-to-digital (A/D) converter to convert the analog signal to "bits," the digital information the controller can understand. To stably control around a setpoint, the controller must be able to sense changes to the velocity pressure that are not too abrupt. One controller manufacturer recommends a setpoint that equates to at least 14 bits. For this manufacturer's controller, which uses a 0-1.5" transducer and a 10 bit A/D converter, 14 bits equates to about 0.004" pressure at the input of the transducer. With a similar transducer and an 8-bit A/D converter, the pressure would be about 0.03".

The steps to calculate the controllable minimum for a particular combination of VAV box and VAV box controller are as follows:

1. Determine the velocity pressure sensor controllable setpoint, VP_m in inches of water (in.w.c.) that equates to 14 bits. This will vary by manufacturer but for lack of better information, assume 0.004" for a 10-

bit (or higher) A/D converter and 0.03" for an 8-bit A/D converter. Ask the VAV box controller manufacturer for the specification of the transducer and A/D converter.²⁶

- Calculate the velocity pressure sensor amplification factor, F, from the manufacturers measured CFM at 1" signal from the VP sensor as follows:

$$F = \left(\frac{4005A}{CFM_{@1''}} \right)^2$$

where A is the nominal duct area (ft²), equal to:

$$A = \pi \left(\frac{D}{24} \right)^2$$

where D is the nominal duct diameter (inches).

See Figure 23 for an example of manufacturer's velocity sensor data. The data on the right side of the graph are the airflows at 1" for various neck sizes (shown on the left). For example using this figure, this manufacturer's sensor has 702 cfm at 1" signal with an 8" neck. Calculate the minimum velocity v_m for each VAV box size as:

$$v_m = 4005 \sqrt{\frac{VP_m}{F}}$$

Where VP_m is the magnified velocity pressure from Step 1.

- Calculate the minimum airflow setpoint allowed by the controls (V_m) for each VAV box size as:

$$V_m = v_m A$$

²⁶ If basing box selection on the performance of a 10 or 12 bit A/D converter, be sure to specify this in the specification section on control hardware. This will somewhat limit the manufacturers that can provide the box controls. Guidance on manufacturers' product offerings can be found on the Iowa Energy Centers, DDC Online Site at <http://www.ddc-online.org/>.

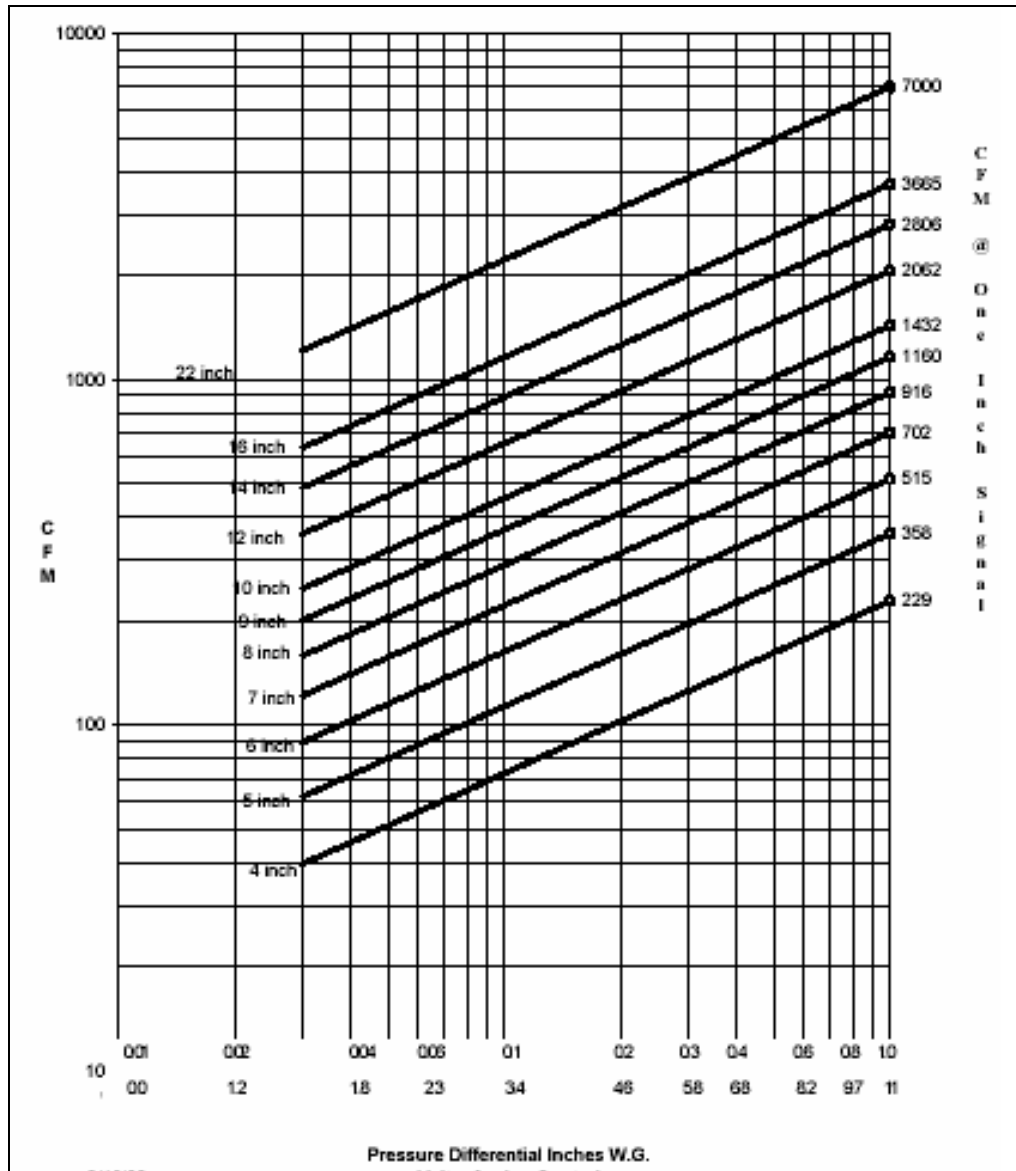

Figure 23. Sample VAV Box Inlet Sensor Performance Chart, CFM vs. Velocity Pressure Signal

We'll illustrate these calculations with an example. Table 13 shows the minimum airflow setpoint V_m for the VAV box probe depicted in Figure 23 with a controller capable of a 0.004" velocity pressure setpoint.

Table 13. Sample Calculation of Box Minimum Flow

Nominal Inlet Diameter, in.	Area, ft ²	Min VP Sensor reading, in. w.g.	CFM @ 1 in. w.g.	Amplification factor	Minimum Velocity, FPM	Minimum Flow, CFM
D	A	VP_m		F	v_m	V_m
4	0.087	0.004	229	2.33	166.02	14
5	0.136	0.004	358	2.33	166.02	23
6	0.196	0.004	515	2.33	166.02	33
7	0.267	0.004	702	2.33	166.02	44
8	0.349	0.004	916	2.33	166.02	58
9	0.442	0.004	1,160	2.33	166.02	73
10	0.545	0.004	1,432	2.33	166.02	91
12	0.785	0.004	2,062	2.33	166.02	130
14	1.069	0.004	2,806	2.33	166.02	177
16	1.396	0.004	3,665	2.33	166.02	232
22	2.64	0.004	7000	2.28	167.71	443

Sizing VAV Reheat Boxes

The key consideration in sizing VAV reheat boxes are determining the box minimum and maximum airflows for each neck size for a given product line. The minimum airflows are determined by the ventilation and controllability issues addressed in the previous section, “Determining the Box Minimum Airflow.” The maximum airflow rate the box can supply is determined from the total pressure drop and sound power levels as discussed below. For a given design airflow rate, more than one box size can meet the load, so the question is which size to use.

Design Maximum Airflow Rate

Before a selection can be made, the design airflow rate must be determined from load calculations. Caution should be taken to determine these loads accurately as VAV box oversizing can lead to significant energy penalties particularly if the conventional single maximum logic (see “Common Practice (Single Maximum)”) is used. For example, assume a VAV box is selected for 1000 cfm with a 30% (300 cfm) minimum. If the box is actually oversized by a factor of 2, then the true design airflow rate is 500 cfm and the effective minimum setpoint is not 30% but 60%, almost a constant volume reheat system. For most operating hours, this box will operate at its minimum airflow rate and temperature will be controlled by reheating the cold supply air.

Noise

VAV box manufacturers provide two types of sound data: discharge and radiated. Discharge noise is rarely an issue if the box has hard duct on the inlet, a lined outlet plenum and flex duct between the plenum and diffusers. As a general rule, VAV boxes located above standard acoustical ceilings should have radiated Noise Criteria (NC) levels no more than ~5 NC above the desired room NC rating. For example, a typical office application with a desired NC level of 30, the VAV box should be selected for a 35 NC.

Note that the assumptions used by manufacturers in determining resulting NC levels should be checked to make sure they apply (see catalog data and ARI rating assumptions). If not, then a more complex calculation using radiated sound power data must be done.

It is important to base the selection on the latest sound power data for the particular box being used. One of the most important contributors to box noise is the design of the flow sensor, which differs from one manufacturer to the next. Since the manufacturers routinely modify the design of their flow sensors, the latest catalog information from the manufacturer's website or local sales representative should be used.

Total Pressure Drop

The total pressure drop (ΔTP), which is equal to the static pressure drop (ΔSP) plus the velocity pressure drop (ΔVP), is the true indicator of the fan energy required to deliver the design airflow through the box. Unfortunately, manufacturers typically only list the static pressure drop which is always lower than the total pressure drop since the velocity at the box inlet is much higher than the outlet velocity, resulting in static pressure regain. Therefore, in order to size boxes when ΔTP is not cataloged, the designer needs to calculate the velocity pressure drop using the following equation:

$$\begin{aligned}\Delta TP &= \Delta SP + \Delta VP \\ &= \Delta SP + \left[\left(\frac{v_{in}}{4005} \right)^2 - \left(\frac{v_{out}}{4005} \right)^2 \right]\end{aligned}$$

The velocity (FPM) at the box inlet and outlet are calculated by dividing the airflow rate (CFM) by the inlet and outlet area (ft²), which in turn is determined from dimensions listed in catalogs)²⁷.

Total Pressure Drop Selection Criteria

As noted above, smaller VAV boxes will have a higher total pressure drop, increasing fan energy, and higher sound power levels. On the other hand, larger boxes cost more and are more limited in how low the minimum airflow setpoint can be set, which can increase fan energy and reheat energy under low load conditions.

Simulations were made to determine the optimum balance from an energy perspective between pressure drop and minimum setpoint limitations. For most applications, the analysis (described in Appendix 6 – Simulation Model Description) indicates that boxes should be selected for a total pressure drop of about 0.5" H₂O.

Table 14 shows the maximum airflows and sound data for a particular box manufacturer based on a total pressure drop of 0.5". The maximum airflow for each box in this table was developed by iterating on the VAV box selection with the manufacturer's selection software: for each box, the maximum CFM

²⁷ Inlet dimensions are typically quite easy to calculate as they are just circular cross sections at the scheduled neck size. Outlets areas can be more difficult since they are typically rectangular flange connections that are much larger than the inlet connections but not always clearly marked in catalogs. VAV box submittal data should be consulted for outlet dimensions.

was sought to obtain both a total pressure drop of less than 0.5" and a radiated NC rating of less than 35. For each iteration, the calculation of total pressure was done in a spreadsheet using the box inlet and outlet size to determine the velocity pressures. Table 14 demonstrates that noise is not an issue for this particular line of VAV boxes. The radiated NC values are quite low at 0.5" total pressure drop. For other manufacturers this may not be the case.

Table 14. VAV Box Maximum Airflows

Nominal size	Inlet diameter (in.)	Outlet width (in.)	Outlet height (in.)	Static pressure drop (in. w.g.)*	Velocity pressure drop (in. w.g.)	Total pressure drop (in. w.g.)	Max CFM	Radiated NC*
4	4	12	8	0.08	0.42	0.50	230	21
5	5	12	8	0.15	0.35	0.50	333	20
6	6	12	8	0.24	0.25	0.49	425	21
7	7	12	10	0.25	0.25	0.50	580	20
8	8	12	10	0.33	0.17	0.50	675	22
9	9	14	13	0.27	0.23	0.50	930	17
10	10	14	13	0.32	0.18	0.50	1100	19
12	12	16	15	0.32	0.17	0.49	1560	19
14	14	20	18	0.31	0.19	0.50	2130	18
16	16	24	18	0.32	0.18	0.50	2730	22

*From selection software

One might think that the 0.5" pressure criterion need only apply to the box with the greatest need for static pressure. This will determine the fan static pressure and hence the fan power. Arguably then, VAV boxes closest to the fan hydraulically (where excess pressure may be available) could be sized for a greater pressure drop than the most remote boxes. However, as described in the following paragraphs, the 0.5" criteria should be applied to all boxes regardless of location.

As loads shift throughout the day and year the most demanding box will change. Figure 24, Figure 25, and Figure 26 are images of VAV box zone demand at different times of day for an office building in Sacramento, California (Site 4). All three images are taken on the same day, August 5, 2002. At 7am, Zone 14 on the southeast corner of the building has the most demand. Later that morning at 9am, Zone 36 in the interior of the building experiences the most demand. At 5pm, the high demand has shifted to Zone 30 in the northwest corner. Throughout the period monitored (the better part of a year), the peak zone changed throughout the floor plate, including both interior and perimeter zones. Hence the zone requiring the most static pressure could vary throughout the day. If fan static pressure is reset to meet the requirements of only the zone requiring the most pressure (see Demand-Based Static Pressure Reset), and if boxes close to the fan are undersized to dissipate excess pressure that is available at design conditions, then fan pressure and fan energy would increase when these boxes become the most demanding during off-design conditions.

Therefore, since the most demanding box changes throughout time, all boxes on a job should be sized using a consistent rule for maximum total pressure drop at design conditions. This is also much simpler and more repeatable.

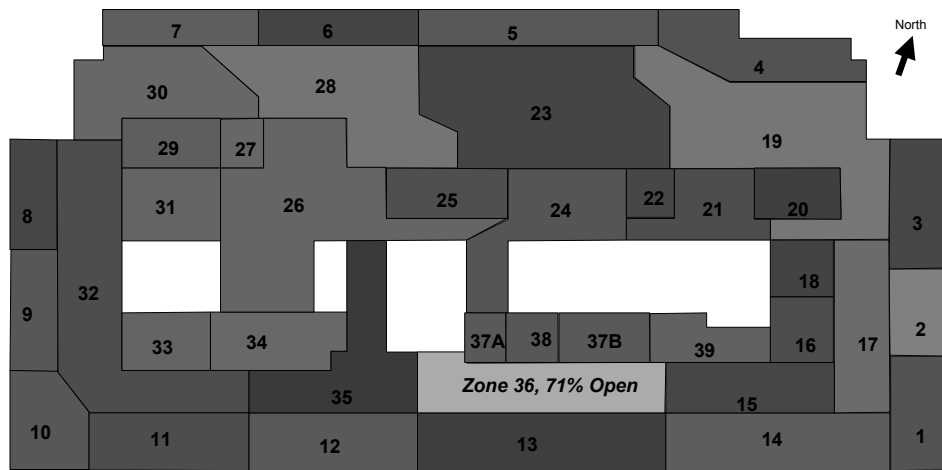
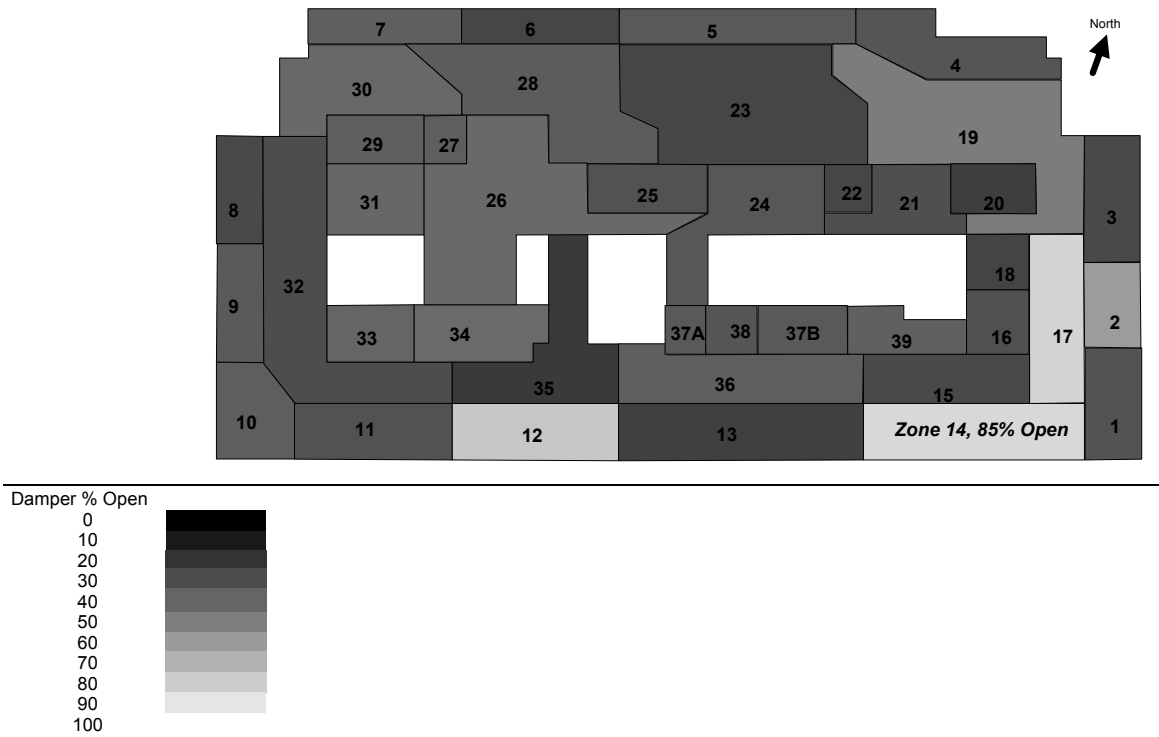



Figure 26. Site 3 VAV Box Demand, 5pm Monday August 5, 2002

Table 15 summarizes the turndowns for typical selection of VAV boxes using the minimum box airflow setpoint (“min CFM”) calculated in Table 13 and the maximum design airflow rates (“max CFM”) calculated in Table 14. The column, “best turndown” is the ratio of the min CFM to the max CFM as if the box size is selected just at the maximum allowable flow rate. Worst turndown is the ratio of the min CFM for that box size to the max CFM of the next smaller box size as if the box had the smallest airflow in it’s size range. These values for best and worst represent the range of potential selections within a given box neck size. They are computed both for all sizes of boxes and, to the right of the table, just for even neck sizes of boxes. Many local VAV box suppliers only stock even sized boxes in their warehouses and thus the lead-time to get odd size boxes (e.g., 5”, 7”, or 9”) to job site can be much longer. Using only even sizes results in less turndown but Appendix 6 – Simulation Model Description shows that the penalty for using only even sizes is fairly small.

Table 15. Summary of Sample Box Max and Min

Nominal size	Max CFM	Min CFM	Odd and Even Sizes		Even Sizes Only	
			Best turndown	Worst turndown	Best turndown	Worst turndown
4	230	14	6%	n/a	6%	n/a
5	333	23	7%	10%		
6	425	33	8%	10%	8%	14%
7	580	44	8%	10%		
8	675	58	9%	10%	9%	14%
9	930	73	8%	11%		
10	1,100	91	8%	10%	8%	13%
12	1,560	130	8%	12%	8%	12%
14	2,130	177	8%	11%	8%	11%
16	2,730	232	8%	11%	8%	11%
Average			9%		10%	

Note: These values were developed using a controller/sensor accuracy of 0.004" w.c.

Other Box Types

Dual Duct Boxes

Dual duct VAV boxes are traditionally purchased with flow sensors in both the hot and cold inlet. However, boxes with flow sensors in the cold inlet, the hot inlet, and/or the outlet are also available. Three controls are recommended: snap-acting with a single sensor in the outlet; mixing control with a single sensor in the outlet; and mixing control with a sensor on the outlet and the cold inlet. All of these configurations are readily available with the sensors mounted from the factory as a standard option.

Snap Acting Controls with a Single Sensor on the Outlet

Figure 27 and Figure 28 show the snap acting dual-duct VAV control scheme, followed by a sample control sequence:

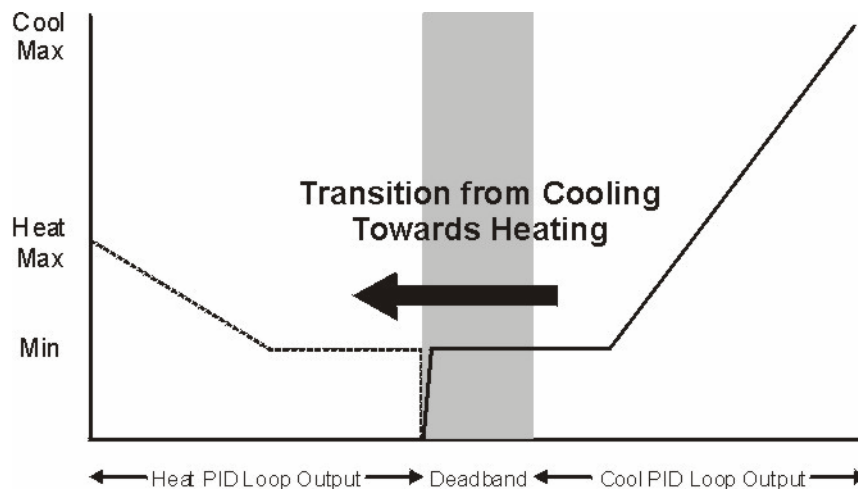

Figure 27. Dual Duct - From Cooling to Heating

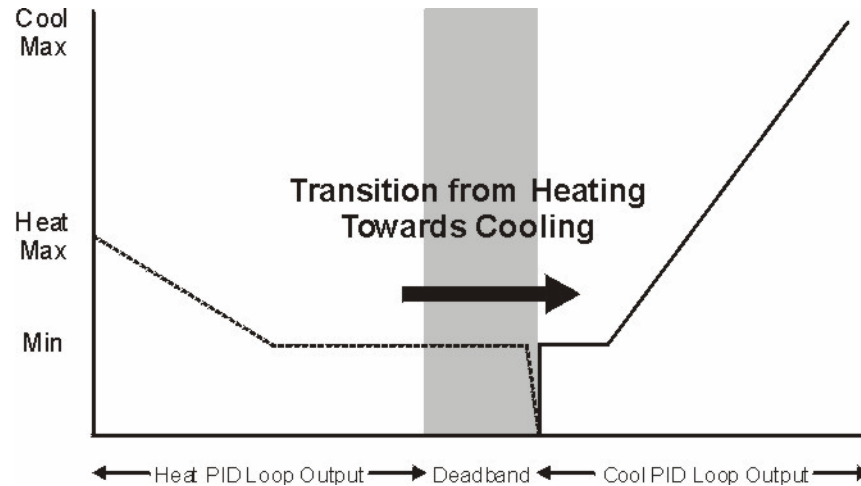

Figure 28. Dual Duct - From Heating to Cooling

Temperature Control

1. When the zone is in the Cooling Mode, the Cooling Loop output shall reset the discharge supply airflow setpoint from the minimum to cooling maximum setpoints. The cooling damper shall be modulated by a PI loop to maintain the measured discharge airflow at setpoint. The heating damper shall be closed.
2. When the zone is in the Heating Mode, the Heating Loop output shall reset the discharge supply airflow setpoint from the minimum to heating maximum setpoints. The heating damper shall be modulated by a PI loop to maintain the measured discharge airflow at setpoint. The cooling damper shall be closed.
3. In the Deadband Mode, the discharge airflow setpoint shall be the zone minimum, maintained by the damper that was operative just before entering the Deadband. The other damper shall remain closed. In other words, when going from Cooling Mode to Deadband Mode, the cooling damper shall maintain the discharge airflow at the zone minimum setpoint and the heating damper shall be closed. When going from Heating Mode to Deadband Mode, the heating damper shall maintain the discharge airflow at the zone minimum setpoint and the cooling damper shall be closed. This results in a snap-action switch in the damper setpoint as indicated in the figures above.

Mixing Controls with a Single Sensor on the Outlet

Figure 29 and Figure 30 show the mixing dual-duct VAV control scheme, followed by a sample control sequence:

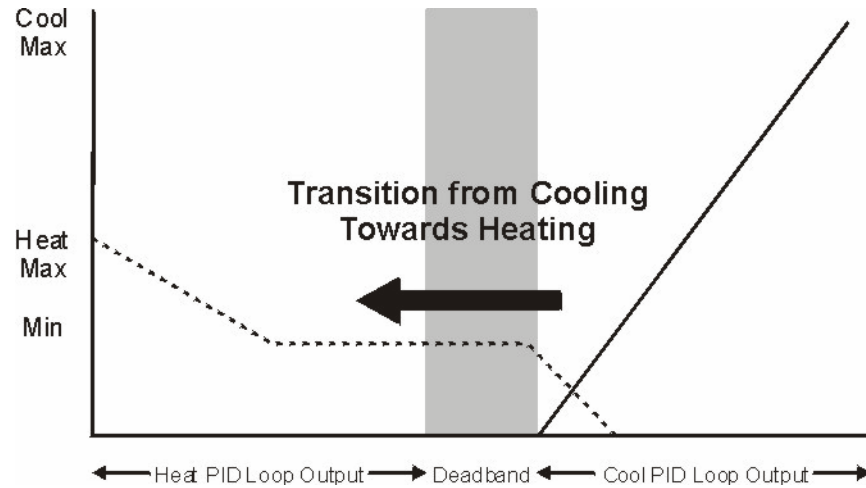

Figure 29. Dual Duct Mixing - From Cooling to Heating

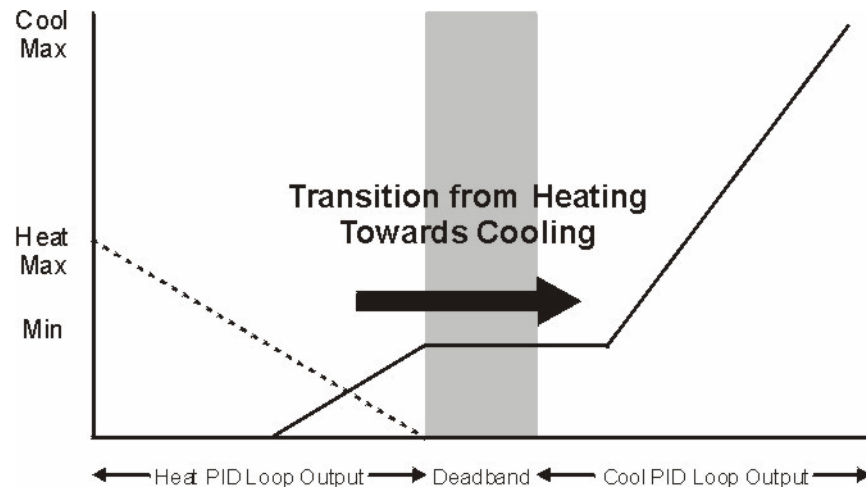

Figure 30. Dual Duct Mixing - From Heating to Cooling

Temperature Control

1. If the system is in the Heating Mode, the Heating Loop output shall be mapped to the heating damper position.
2. If the system is in the Cooling Mode, the Cooling Loop output shall be mapped to the cooling damper position.
3. In the Deadband Mode, the cooling and heating dampers are controlled to maintain minimum airflow, as described below.

Minimum Volume Control

1. In the Heating Mode, the cooling damper is modulated to maintain measured discharge airflow at the minimum airflow setpoint.
2. In the Cooling Mode, the heating damper is modulated to maintain measured discharge airflow at the minimum airflow setpoint.

3. In Deadband Mode, the last damper that was used to maintain minimum airflow continues to do so (e.g., in transitioning from Heating into Deadband Mode, the cooling damper would continue to maintain minimum airflow).

Maximum Volume Control

1. This control takes precedence over Temperature Control command of outputs so that supply air volume does not exceed the maximum regardless of the temperature control logic.
2. In the Heating Mode, if the discharge supply airflow rises above the maximum heating airflow setpoint, the heat temperature control loop shall no longer be allowed to open the damper. If the discharge supply airflow rises above the maximum heating airflow setpoint by 10%, the heating damper shall be closed until the airflow falls below setpoint.
3. In the Cooling Mode, if the discharge supply airflow rises above the maximum cooling airflow setpoint, the cool temperature control loop shall no longer be allowed to open the damper. If the discharge supply airflow rises above the maximum cooling airflow setpoint by 10%, the cooling damper shall be closed until the airflow falls below setpoint.

Comparison of Dual Duct Control Logic

Table 16 below discusses the advantages and disadvantages for each of these controls.

Table 16. Comparison of Dual-Duct VAV Controls

Issue	Snap-Acting with a Single Sensor in the Outlet	Mixing Control with a Single Sensor in the Outlet	Mixing Control with a Sensor on the Outlet and the Cold Inlet
Pressure Independent Control	Yes	No	Yes
First Cost	Low	Low	High
Works with Demand Ventilation (CO ₂ Reset) Controls	No	Yes	Yes
Reheat Energy	None	Yes	Yes
Thermal Comfort	Ok	Better	Better

As shown in Table 16, advantages and disadvantages exist for each scheme. The snap acting control has both low cost and low reheat energy, but it experiences wider zone temperature fluctuations and will not work with demand ventilation controls and other applications where the minimum airflow setpoint is a large fraction of the design maximum setpoint. The mixing controls have better thermal comfort and will work with demand ventilation controls, but the designer has to either save money and sacrifice pressure independent control or buy another sensor (and analog input point) to get the highest thermal performance. In general, the recommended approach is the single outlet sensor with snap-acting controls for zones without DCV and mixing control with a single discharge sensor for zones with DCV.

The reason that snap-acting controls cause higher temperature fluctuations is that they change rapidly between minimum flow with hot air and with cold air, which also prevents them from working with demand ventilation controls. The temperature fluctuations are relatively imperceptible at minimum design airflow. Demand ventilation controls increase this minimum as more people enter the space. At an extreme, this situation could cause the box to fluctuate between full cooling and full heating with no dead band in between.

The loss of pressure independence with the single sensor mixing scheme is not significant when coupled with a demand limit on cfm (see Demand-Based Static Pressure Reset). Compared with the premium of \$500 to \$1,000 per zone for an extra sensor and analog input, it usually makes sense to use this configuration unless cost is not a concern for the client.

The sections below describe each configuration.

Sizing Dual Duct Boxes

Dual duct boxes should be sized in the same manner as the single duct: the maximum CFM per box is based on a uniform rule for total pressure drop (e.g. ≤ 0.5 " w.c.), provided noise levels are acceptable. As with reheat boxes, the minimum controllable airflow setpoint is a function of the amplification factor of the velocity sensor, the minimum velocity pressure setpoint capability of the controller, and the duct area at the sensor location. It is important to use the area of the outlet in this calculation if the sensor is in the outlet. Outlet sizes are typically larger than inlet sizes but this varies by manufacturer).

The pressure drop across dual duct boxes differs widely depending on the style of box and the placement of the velocity pressure sensors. Boxes that have mixing baffles to ensure complete mixing of the hot and cold airstreams have the highest pressure drops. Complete mixing is only a factor when mixing control logic is used (it is not an issue with snap-acting since the hot and cold dampers are never open at the same time) and it is only an issue when the VAV box is serving multiple rooms where inconsistent supply air temperature can upset balance. When discharge velocity pressure sensors are used, the discharge outlet is often reduced from the size used when dual inlet velocity pressure sensors are used. This is intended to increase velocity and improve airflow measurement, but it also results in better mixing of the two airstreams and it increases pressure drop. The pressure drop for this design varies widely among manufacturers; the bid list should be limited to the best one or two or require that boxes be increased in size to match the pressure drop performance of the specified manufacturer. With a discharge airflow sensor, we have found mixing to be sufficient from a comfort perspective for most applications. Mixing baffles, which add significantly to both first costs and pressure drop, should only be used for the most demanding applications (e.g. hospitals).

In calculating the velocity pressure loss from a dual duct VAV box, note that although the outlet sensor is typically in a round duct, the connecting duct is typically a larger rectangular duct connected to a flange on the discharge plate. The manufacturers use this larger rectangular duct size in rating the duct static pressure loss so its area should be used to determine outlet velocity pressure.

Series Fan Powered Boxes

Series fan powered boxes should be avoided, with the exception of a few specific applications, because the small fans and motors in fan-powered boxes are highly inefficient (as low as 15% combined efficiency compared to central fans with 60% or greater combined efficiencies).

Series fan powered boxes are recommended for the following zones within a VAV-reheat system:

- Series boxes are one of the recommended options for interior conference rooms; see Design of Conference Rooms for an explanation and discussion of other options.
- Series boxes should be used for any space that requires a high minimum flow rate in order to maintain good mixing, to prevent dumping, or to meet the heating load at a reasonable supply air temperature (e.g. <90°F). For example, a large two-story lobby or atrium might have a sidewall diffuser at the height of the first story. Without a ceiling above the diffuser to provide the Coanda effect, the diffuser might “dump” at low flows and not be able to “throw” across the entire space. A series box maintains constant velocity under all load conditions.

Controls on systems with series-style boxes should stage the boxes on before the central fans are activated in order to prevent the box fans from running backwards. Single phase motors will run backwards at reduced airflow rates if they are spinning in reverse when they are started.

ECM Motors

Series fan powered boxes are available with high efficiency electrically commutated motors (ECM). While these cost more than conventional fixed speed motors, they generally pay for themselves in energy savings.

In the proposed 2005 version of the Title 24 Standard, ECM motors are required for all series style boxes with motors under 1 HP.

Parallel Fan Powered Boxes

Parallel fan powered boxes can reduce or eliminate reheat, but the first cost and maintenance cost are higher than reheat boxes. The cycling of parallel box fans also may be an acoustical nuisance.

The efficiencies of the parallel fan and motor are not a significant issue as they are with series boxes because the fan generally operates only in the heating mode. Since all the fan energy is supplied to the space, it is simply a form of electric resistance heat and not “lost” or reheated.

If the dual maximum control strategy is used along with maximum and minimum airflow setpoints determined as described above, VAV reheat boxes are almost always a better option than parallel fan powered boxes on a life-cycle cost basis. The exception may be if fan-powered boxes can be operated with zero minimum airflow setpoints (see Zero Minimums), thus completely eliminating reheat losses and significantly reducing fan energy.

Unlike series-style boxes, parallel-style boxes do not need special controls to prevent them from running backwards. They are provided with integral

backdraft dampers that prevent system air from escaping out of the plenum when the box fan is off.

Other Issues

Zero Minimums

Some will argue that VAV boxes can have zero minimum airflow setpoints because if there is a need for ventilation, i.e., the space is occupied, there will also be a cooling load in the space, so the thermostat will call for cooling and the VAV box will provide the necessary ventilation. However, this does not strictly meet Title 24 which requires that the minimum ventilation rate be provided whenever the space is “expected” to be occupied, including times during the day when the space may not be occupied and at low load (see “Code Ventilation Requirements”). Nevertheless, zero minimum airflow setpoints are acceptable under some circumstances:

- Multiple zones serving open office plan. The code allows some VAV boxes serving a space to go to zero airflow, provided other boxes serving that space are controlled to provide sufficient minimum ventilation for the entire space. For example, a large open office plan might be served by two boxes, one in the interior and one along the perimeter. Suppose the perimeter were 1000 ft² and designed for 2000 cfm (2 CFM/ft²) while the interior was 1000 ft² and designed for 500 cfm (0.5 CFM/ft²). The minimum airflow rate required for ventilation is 0.15 cfm/ft² or 300 cfm. Code could be met using an cooling-only box in the interior with a zero minimum airflow setpoint, and a reheat box serving the perimeter with a 15% (300 cfm) minimum setpoint. If the interior box is controlled to maintain its ventilation rate alone (equal to 30% of its maximum), then a reheat coil would need to be added to this box to prevent overcooling the space at minimum flow. Therefore, combining interior cooling-only boxes with perimeter reheat boxes in open office plans saves first cost and energy. (This concept does not apply when the interior and perimeter are separated from each other with full height partitions.)
- Multiple zones serving a large zone. Another application where zero minimum airflow setpoints are allowed is for large zones (e.g., large meeting rooms) where more than one box may be needed to meet the load. In this case, one or more of the boxes could have a zero minimum, as long as at least one box has a non-zero minimum that can meet the minimum ventilation requirements for the entire zone.
- Fan-powered boxes. Zero minimum volume setpoints are an option on series and parallel style fan-powered boxes since the box fan can be used to supply the minimum ventilation rate using plenum air. Title 24 specifically allows transfer air to be used to meet ventilation requirements provided the system as a whole is provided with the sum of the outdoor air rate required for all spaces served by the system. This design will only work, however, if there are always some zones served by the system that are supplying sufficient air that the minimum outdoor air for the system can be maintained at the air handler. For example consider a system serving a combination of interior and perimeter zones with fan-powered boxes with zero

minimum airflow setpoints at the perimeter. In cold weather, all the perimeter boxes will be in the heating mode and shut off. The load in interior spaces must always be equal to or greater than the minimum ventilation rate to provide enough airflow for the entire system ventilation requirements. If this is not the case, non-zero minimums must be used at the perimeter. (A heating coil may also be needed at the air handler to prevent supply air temperature from falling too low since the minimum outdoor air may be nearly 100% of the supply air under this cold weather design condition.)

Cooling-Only Boxes

In times past when interior lighting and PC loads were substantially higher than they are now, interior spaces did not need heat and therefore could be served by cooling-only VAV boxes. The loads were sufficient to allow boxes to be set to minimum rates required for ventilation without overcooling. But with the very low lighting and plug load power densities now common, overcooling is very possible, even likely. Except where zero minimums may be used (see discussion above in “Zero Minimums”), reheat is probably required to ensure both comfortable temperatures and adequate ventilation for interior areas. Reheat is also required for interior zones with floor heat loss, such as from slabs on grade or over an unconditioned basement/garage.

Electric Reheat

Title 24 has a prescriptive requirement that significantly limits the use of electric resistance heat. There are a few exceptions and electric heat can be used if compliance is shown using the Performance Approach where additional source energy from the electric heat can be offset by other energy conservation measures. Still, few applications for electric resistance heat exist in California commercial buildings. Federal facilities, hospitals, and prisons use different energy codes and may be able to use electric heat. Site 3, a State building, had electric heat with series fan-powered boxes. In mild and warm climates with good envelopes (i.e., where there are low heating loads), electric heat may be the best life-cycle cost choice, but it will have difficulty complying with Title 24.

Where electric resistance heat is used, the National Electric Code (NEC) requires both airflow switches and thermal switches on electric coils. The airflow switches provided with electric coils are often low quality and require a relatively high airflow to prove flow. As a result, the effective minimum airflow for electric coils is higher than that for hot-water coils. As a general rule, a minimum VP sensor reading of 0.03” is recommended for electric reheat. Table 17 shows typical turndown ratios for electric reheat.

All electric coils are required to have automatic reset thermal switches. On large coils a second manual reset thermal switch is required. Where electric heat is used, the controls should ensure that the fans run for several minutes before and after the heating coil has been engaged to prevent tripping of the thermal switches. It only takes a few false trips to convince a building operator to run the system continuously to prevent having to reset thermal switches above the ceiling.

Table 17. VAV Box Turndown with Electric Reheat

Nominal size	Max CFM	Min CFM	Odd and Even Sizes		Even Sizes Only	
			Best turndown	Worst turndown	Best turndown	Worst turndown
			17%	n/a	17%	n/a
5	333	62	19%	27%		
6	425	89	21%	27%	21%	39%
7	580	122	21%	29%		
8	675	159	24%	27%	24%	37%
9	930	201	22%	30%		
10	1,100	248	23%	27%	23%	37%
12	1,560	357	23%	32%	23%	32%
14	2,130	486	23%	31%	23%	31%
16	2,730	635	23%	30%	23%	30%
Average			25%		28%	

Note: These values were developed using a controller/sensor accuracy of 0.004" w.c.

DDC at the Zone Level

Pneumatic controls are extremely simple to maintain and inexpensive to install. Pneumatic actuators are fast acting – a characteristic that keeps them in the market for lab exhaust controls. However, in general, pneumatic controls are less precise than DDC controls and do not easily provide the zone feedback that can make VAV systems truly efficient.

A number of the control sequences in this document rely on zone feedback, including the supply pressure setpoint reset for air-handling units or central fans, and supply temperature setpoint reset for central coils. These sequences can provide significant energy savings, but savings are rarely large enough to justify the ~\$700/zone cost premium of DDC over pneumatic controls. But DDC offers other benefits that make the cost premium worthwhile to most owners and builders; currently DDC is provided for the majority of zone controls and nearly 100% of the market for new buildings.

Benefits of DDC at the zone level other than energy savings include:

- Zone control problems can be remotely detected, alarmed, and diagnosed by building engineers or service technicians
- Elimination of compressed air system and associated maintenance
- More precise zone temperature control
- Ability to restrict thermostat setpoints in software to prevent occupant abuse
- Reduced calibration frequency
- Ability to intertie occupancy sensors, window switches, and CO₂ sensors
- Ability to allow occupants to view and/or adjust their controls from their computer (requires a web-based DDC system)

Given the cumulative effect of energy savings and other benefits, we recommend DDC zone controls for new systems. In existing buildings, we

recommend upgrading central systems to DDC and replacing the zones with DDC controllers only during future tenant build-outs and remodels.

Duct Design

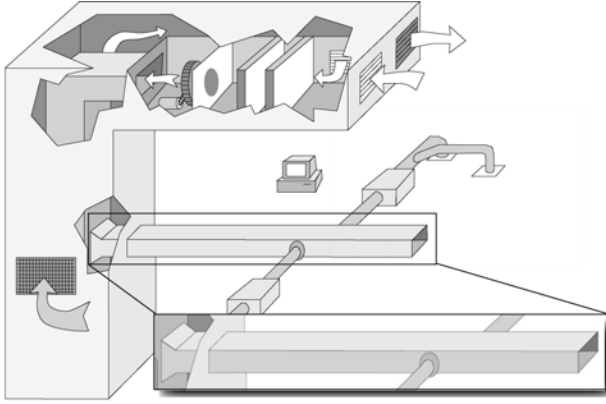

- General Guidelines
- Supply Duct Sizing
- Return Air System Sizing
- Fan Outlet Conditions
- Noise Control

This section provides guidance on designing cost effective, energy-efficient duct distribution systems.

General Guidelines

Duct design is an art as much as it is a science. To design duct systems well requires knowledge of both the principles of fluid flow and the cost of duct and duct fittings. The ideal system has the lowest life-cycle cost (LCC), perfectly balancing first costs (cost of the duct system and appurtenances such as dampers, VAV boxes, etc.) with operating costs (primarily fan energy costs). To rigorously optimize LCC is impractical even with a very large engineering budget; there are simply too many variables and too many unknowns. For instance, first costs are not simply proportional to duct size or weight. Fittings cost more than straight duct and round ducts generally cost less than rectangular ducts. Some fittings that serve the same purpose are more expensive than others, depending on duct size and the capabilities of the sheet metal shop. It is therefore difficult for a designer to optimize the design of the duct system absent knowledge of who will be building the system. Estimating operating costs is also inexact to a large part because duct system pressure drops cannot be accurately calculated (see additional discussion below).

Still, some rules of thumb and general guidelines can be developed to help designers develop a good design that provides a reasonable, if not optimum, balance between first costs and operating costs, including the following:

1. Go straight! This is the most important rule of all. The straighter the duct system, the lower both energy and first costs will be. From an energy perspective, air “wants” to go straight and will lose energy if you make it bend. From a cost perspective, straight duct costs less than fittings. Fittings are expensive because they must be hand assembled even if the pieces are automatically cut by plasma cutters. So, when laying out a system, try to reduce the number of bends and turns to an absolute minimum.

2. Use standard length straight ducts and minimize both the number of transitions and of joints since the sheet metal is not as expensive as the labor to connect pieces together and seal the joints. Straight, standard length ducts are relatively inexpensive since duct machines, such as coil lines for rectangular ducts, automatically produce duct sections. Standard sheet metal coils are typically 5 feet wide, so standard rectangular duct lengths are 5 feet long (somewhat less for machines that bend flanges and joints out of the coil metal). Any rectangular duct that is not a standard length is technically a fitting since it cannot be made by the coil line. While spiral round duct can be virtually any length, it is commonly cut to 20 feet to fit in standard trucks. Oval duct standard lengths vary depending on the fabricator but manufactured ducts are typically 12 feet long. It is not uncommon for an inexperienced design to include too many duct size reductions with false impression that reducing duct sizes will reduce costs. In Figure 31, four transitions are reduced to one with each remaining duct section sized for multiples of the standard 5-foot rectangular duct length, which reduces both first costs and energy costs.
3. Use round spiral duct wherever it can fit within space constraints. Round duct is less expensive than oval and rectangular duct, especially when run in long, straight sections. Round duct fittings are relatively expensive, so this rule would not apply where there are many transitions, elbows, and other fittings close together. Round spiral duct also leaks less than rectangular duct due the lack of longitudinal joints and generally fewer transverse joints when run in long straight duct sections. Round duct also allows less low frequency noise to break-out since it is round and stiff. The flat sections of rectangular duct and wide flat oval duct behave like a drum, easily transmitting low frequency duct rumble. Flat oval duct is often the next best option when space does not allow use of round duct. The cost, however, will vary by contractor since some have the machines to fabricate oval duct while others must purchase factory-made duct and fittings. Rectangular duct should usually be limited to ducts that must be acoustically lined (lining rectangular duct is least expensive since it can be done automatically on coil lines), for duct sections containing many fittings (rectangular duct fittings are usually easier to assemble than round and oval fittings), and for large plenums.

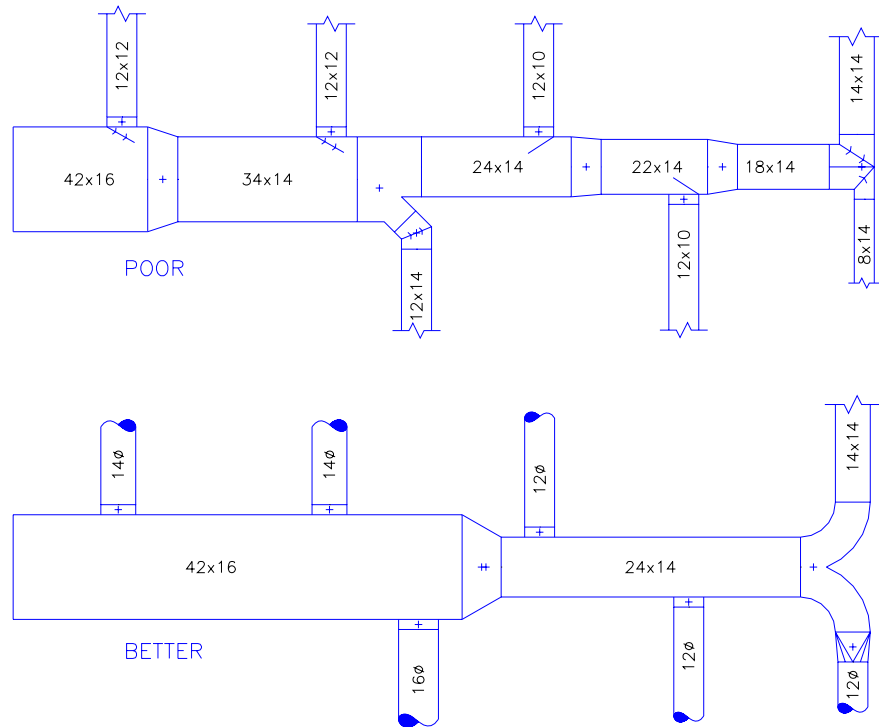

Figure 31. Examples of Poor and Better Duct Design

4. Use radius elbows rather than square elbows with turning vanes whenever space allows. Figure 32 and Figure 33 show the performance of elbows and tees in various configurations. Except for very large ducts (those whose shape cannot be cut on a 5-foot wide plasma cutter), full radius elbows will cost less than square elbows with turning vanes, yet they have similar pressure drop and much improved acoustic properties. Turning vanes generate some turbulence, which can be noisy at high velocities. On medium and high velocity VAV systems, where a full radius elbow cannot fit, a part-radius elbow with one or more splitters should be used. The splitters essentially convert the duct into nested full-radius elbows. This design will have the lowest pressure drop and produce the least noise. Turning vanes should only be used on low velocity systems where radius elbows will not fit. Turning vanes should be single width, not airfoil shaped. Intuitively, airfoil vanes would seem to offer better performance but SMACNA and ASHRAE test data show that they have higher pressure drop as well as higher cost.

DUCT ELBOWS
(EXAMPLES AT 2000 FPM. SQUARE DUCT)

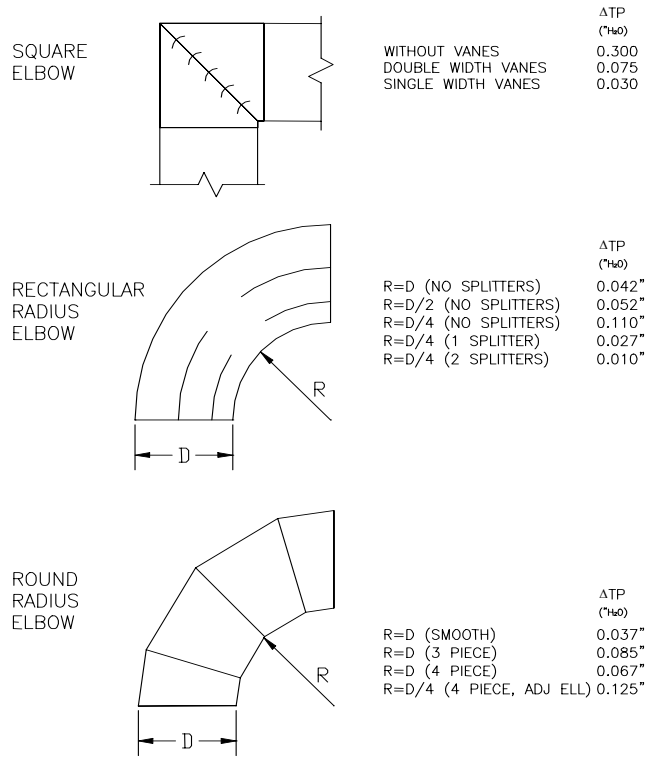
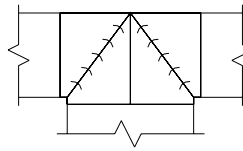

Figure 32. Pressure Drop Through Elbows

RECTANGULAR TEES

(EXAMPLES AT 2000 FPM MAIN, 1800 FPM BRANCH, $Q_1=Q_2=Q_m/2$)SQUARE
W/
VANES ΔTP
($^{\circ}H_2O$)
0.06"

WYE

 ΔTP
($^{\circ}H_2O$)
0.055"NESTED
WYE ΔTP
($^{\circ}H_2O$)
0.05"

Figure 33. Pressure Drop Through Rectangular Tees

5. Use either conical or 45° taps at VAV box connections to medium pressure duct mains. Taps in low velocity mains to air outlets will have a low pressure drop no matter how they are designed. Use of conical taps in these situations is not justified because the energy savings are small. Inexpensive straight 90° taps (e.g., spin-ins) can be used for round ducts and 45° saddle taps are appropriate for rectangular ducts. Taps with extractors or splitter dampers should never be used. They are expensive; they generate noise; and most importantly, they cause an increase in the pressure drop of the duct main. Since fan energy is determined by the pressure drop of the longest run, increasing the pressure drop of the main can increase fan energy. These devices reduce the pressure drop in the branch only, which is not typically the index path that determines fan energy. Also, the pressure drop through the branch will be about the same as with conical or 45° saddle taps, both of which are less expensive. So there are no redeeming qualities that would ever justify the use of extractors or splitter dampers.
6. VAV box inlets should be all sheet metal; do not use flex duct. This will reduce pressure drop because the friction rate of VAV inlet ducts is very high when sized at the box inlet size. It also will ensure smooth inlets to the VAV box velocity pressure sensor, improving airflow measurement accuracy, and reduce breakout noise from the VAV damper (flex duct is virtually transparent to noise).

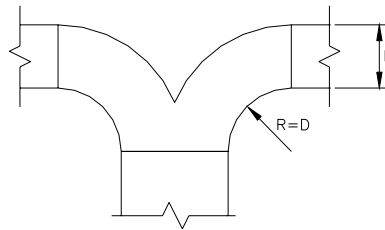
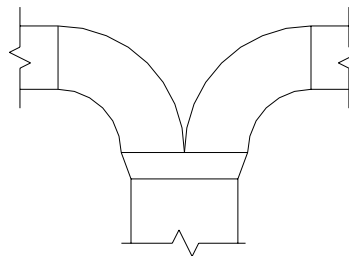
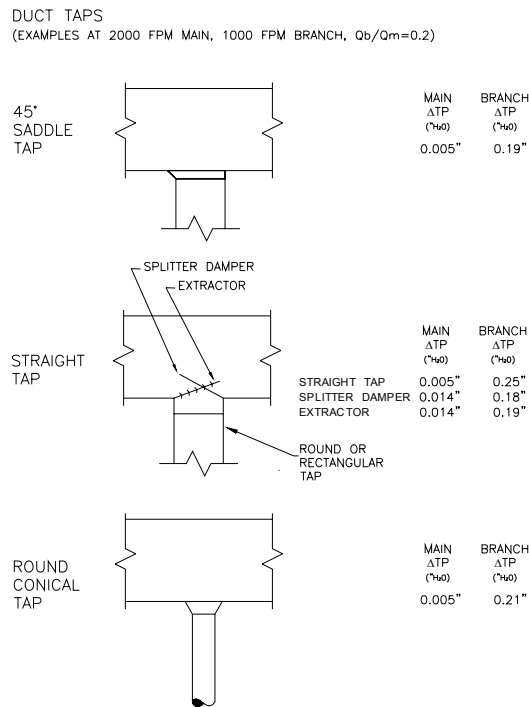

Figure 34. Pressure Drop Through Duct Taps

- Avoid consecutive fittings because they can dramatically increase pressure drop. For instance, two consecutive elbows can have a *50% higher pressure drop* than two elbows separated by a long straight section. A tap near the throat of an elbow can even result in air being induced backwards into the fitting – essentially an infinite pressure drop.

Pressure loss data for duct fittings are available from ASHRAE and SMACNA publications (see the SMACNA HVAC Systems Duct Design Manual, the Duct Design section of the ASHRAE Handbook of Fundamentals or ASHRAE's Duct Fitting Database).

Supply Duct Sizing

Ideally, duct-sizing techniques such as the T-method or the static regain method should be used (ASHRAE Handbook of Fundamentals, 2001, Chapter 34), but they seldom are in actual practice for two primary reasons. First, they are complex and require computer tools to implement, which increases design time and costs. Second, and perhaps most important, the methods are over-simplified because they do not account for duct system effects. System effects include the added pressure drop resulting from consecutive fittings that cannot accurately be estimated by either hand or computer calculations since each fitting combination is unique. Fan system effects result from fans with fittings at their inlets or discharges that result in large pressure drops or uncataloged reductions in performance. System effects, both at the fan and in the duct system, can account for 50% or more of the total system pressure drop. Therefore, using a complex computerized duct sizing method

may not be justified given that the accuracy may be not much better than simpler hand methods.

Low pressure ducts (ducts downstream of terminal boxes, toilet exhaust ducts, etc.) are typically sized using the equal friction method (ASHRAE Handbook of Fundamentals, 2001, Chapter 34) with friction rates in the range of 0.08" to 0.12" per 100 feet. This design condition should be considered an overall average rather than a hard limit in each duct section. For instance, rather than changing duct sizes to maintain a constant friction rate in each duct section as air is dropped off to outlets, it can be less expensive, but result in similar performance, if the duct near the fan has a somewhat higher rate (e.g., 0.15" per 100 feet) and the duct size remains the same for long lengths as air is dropped off. The lower friction rate in the end sections offset the higher rate near the fan, but overall the system costs less because reducers are avoided.

For medium pressure VAV supply ducts, a relatively simple duct sizing technique called the friction rate reduction method is recommended. The procedure is as follows:

1. Starting at the fan discharge, choose the larger duct size for both of the following design limits:
 - a. **Maximum velocity (to limit noise).** Velocity limits are commonly used as a surrogate for limiting duct breakout noise. Many argue it is a poor indicator since noise is more likely to result from turbulence than velocity; e.g., a high velocity system with smooth fittings may make less noise than a low velocity system with abrupt fittings. Nevertheless, limiting velocity to limit noise is a common practice. It is important to consult with the project's acoustical engineer on this issue. Many rules-of-thumb for velocity limits exist depending on the noise criteria of the spaces served and the location of the duct. The typical guidelines for office buildings are:
 - i. 3500 fpm in mechanical rooms or shafts (non-noise sensitive).
 - ii. 2000 fpm for ducts in ceiling plenums.
 - iii. 1500 fpm for exposed ducts.
 - b. **Maximum friction rate (to limit fan power).** A reasonable starting friction rate for VAV systems is 0.25" to 0.30" per 100 feet. The rationale for this range appears below.
2. At the end of the duct system, choose a minimum friction rate, which is typically 0.10" to 0.15" per 100 feet.
3. Decide how many transitions will occur along the hydraulically longest duct main (the so-called "index run," the run with the highest pressure drop that will determine the design pressure drop and fan power) from the fan to the most remote VAV box. Typically, a transition should not be made any more frequently than every 20 feet since the cost of the transition will generally offset the cost of the sheet metal savings. The design is more flexible to accommodate future changes and is more energy efficient with fewer transitions. It is not uncommon to have only three or four major transitions along the index run.
4. Take the difference between the maximum friction rate as determined in step 1 (whether determined by the friction limit or velocity limit) and the

minimum friction rate from step 2 (e.g., 0.3" less 0.1" = 0.2") and divide it by the number of transitions. The result is called the friction rate reduction factor.

5. Size duct along the index run starting with the maximum friction rate, then reduce the friction rate at each transition by the friction rate reduction factor. By design, the last section will be sized for the minimum friction rate selected in step 2.

The method is illustrated in Figure 35 that shows a riser diagram of a simple three-story building:

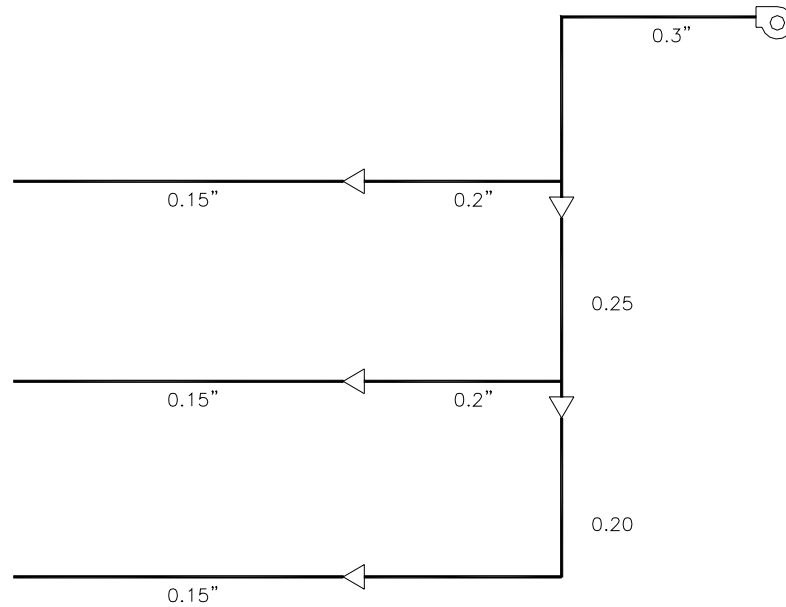

Figure 35. Example of Duct Sizing Using the Friction Rate Reduction Method

In this example, we start with a maximum friction rate of 0.3 and end with a minimum rate of 0.15 at the beginning of the last section. The index run connects to the first floor. Three transitions exist so the friction rate reduction factor is $(0.3 - 0.15)/3 = 0.05$ ". Each section of the run is sized for ever-decreasing friction rates. The other floors should be sized for the same friction rate as the duct on the index floor – 0.2" per 100 feet in this example – primarily for simplicity (typical floors will have the same size ducts).

This technique emulates the static regain method, resulting in somewhat constant static pressure from one end of the duct section to the other, but without complex calculations. It is not intended to be precise, but precision is not possible in most cases due to system effects and the normal changes that occur as design progresses. It is also important to realize that precise duct sizing is not necessary for proper operation because VAV boxes can adjust for a wide range of inlet pressures, generally more than what occurs in medium pressure systems designed using the friction rate reduction method.

Design Friction Rates for VAV Systems

Some may consider the 0.3" per 100 feet initial friction rate to be very high for an energy conserving design. But this design condition represents a reasonable balance between first costs (including cost of sheet metal ducts plus the space required to house them) and energy costs, recognizing that VAV systems seldom operate at their design capacity.

The appropriateness of this friction rate as a design condition can be demonstrated by an analysis of the life-cycle costs of a simple duct distribution system. Assume that the life-cycle cost (LCC) of the duct system is the sum of first costs (FC) and life-cycle energy costs (EC, equal to annual energy costs adjusted by a life cycle present worth factor), as shown in the equation below:

$$LCC = FC + EC$$

First costs are roughly proportional to duct surface area (area of sheet metal). For round ducts, costs would then be proportional to duct diameter D :

$$FC \propto D$$

Assuming that energy costs for a given fan system are proportional to duct friction rate, the friction rate in a standard duct system can be calculated from the following equation that is used in friction rate nomographs like the Trane Ductulator:

$$f \propto D^{-1.2} V^{1.9}$$

where D represents the duct hydraulic diameter and V is the velocity.

For a round duct, the velocity for a given airflow rate is inversely proportional to the square of the diameter, so the friction rate varies with diameter:

$$f \propto D^{-5}$$

Based on the equations above, the life cycle cost as a function of diameter would be:

$$\begin{aligned} LCC &= FC + EC \\ &= K_1 D + K_2 D^{-5} \end{aligned}$$

and as a function of friction, the LCC would be calculated as:

$$LCC = C_1 f^{-0.2} + C_2 f$$

where K and C are constants for a given system.

LCC is minimized for a given friction rate when the derivative of the LCC with respect to friction rate is zero:

$$\frac{\partial LCC}{\partial f} = 0 = -0.2 C_1 f^{-1.2} + C_2$$

Now assume that a constant volume system has a minimum LCC when the friction rate is 0.1" per 100 feet. This is probably the most common design friction rate used for constant volume and low velocity duct systems:

$$0 = -0.2C_1(0.1)^{-1.2} + C_2$$

$$3.2C_1 = C_2$$

The LCC equation can be simplified to:

$$LCC = C_1f^{-0.2} + 3.2C_1f$$

If assuming that the system is variable volume, at an average annual airflow rate of 60%, a VAV system with a variable speed drive will use about 30% of the energy used by a constant volume system of the same design size. The LCC equation then becomes:

$$LCC = C_1f^{-0.2} + 0.3 * 3.2C_1f$$

$$= C_1f^{-0.2} + 0.96C_1f$$

Taking the derivative with respect to friction rate and setting to zero, it is possible to solve for the friction factor that results in the lowest LCC:

$$\frac{\partial LCC}{\partial f} = 0 = -0.2C_1f^{-1.2} + 0.96C_1$$

$$f = (0.21)^{-0.83}$$

$$= 0.27$$

While this analysis is fairly simplistic, it does demonstrate that sizing ducts for a higher friction rate for VAV systems than for constant volume systems is technically justified based on life-cycle cost. If 0.1" per 100 feet is the "right" friction rate for constant volume systems, then 0.25" to 0.3" per 100 feet is "right" for VAV systems. Note that with the friction rate reduction method, this rate is only used for the first section of duct, so average friction rates will be less, but still greater than that for constant volume systems.

Return Air System Sizing

The return airflow rate is equal to the supply rate minus building exhaust and an amount that will mildly pressurize the building to reduce infiltration. The amount of air required for mild pressurization (between 0.03" to 0.08" above ambient) will vary with building construction tightness. Rules of thumb for typical commercial systems are between 0.1" and 0.15 cfm/ft². The 0.15 cfm/ft² rate matches the minimum outdoor air quantities for ventilation required by Title 24 for most commercial buildings. If this air were returned through the shaft, it would have to be exhausted anyway. By reducing the return airflow rate by this amount, return air path space requirements and return/relief fan energy usage are reduced.

Techniques for sizing ducted returns depend on the economizer relief system. For instance, if relief fans are used, the pressure drop should be kept low so ducts are sized using low friction rates much like constant volume systems.

For systems with return fans, return air ducts are typically sized using the same technique used to size supply air ducts.

Unducted return airshafts, as shown in Figure 8, are typically sized for low pressure drop, using either a fixed friction rate, velocity, or both.

To size the shaft on friction rate basis, the hydraulic (or equivalent) diameter of the shaft must be calculated using the formula:

$$HD = \frac{4A_{free}}{P_{wetted}}$$

where A_{free} is the free area and P_{wetted} is the “wetted” perimeter. The “wetted” perimeter is the length of the duct surface that is touching the air stream.

Looking at the example in Figure 8, A_{free} is the plan area of the shaft minus the area of all ducts in the shaft (including the take-off to the floor!). P_{wetted} is the length of the inside perimeter of the shaft wall plus the outside perimeter of the ducts in the shaft. The friction rate is then calculated using the hydraulic diameter and the standard SMACNA/ASHRAE equations for losses (see either the SMACNA HVAC Systems Duct Design Manual or the Duct Design section of the ASHRAE Handbook of Fundamentals).

Typically, shaft area is simply sized using velocity rather than friction rate. Maximum velocities are generally in the 800 fpm to 1200 fpm range through the free area at the top of the shaft (highest airflow rate).

Fan Outlet Conditions

Fan performance is rated using a test assembly with long straight sections of ductwork at the fan discharge. However, in practice, these long duct runs are seldom possible. Fans typically discharge very close to an elbow or other fitting. The result is that the fan will not operate as cataloged, behaving instead as if it were operating against an additional pressure drop. To achieve a given airflow, fan speed and energy use will be higher than what is indicated on performance curves. The extent of this “fan system effect” depends on how close the fitting is to the fan discharge and the orientation of the fitting with respect to the rotation of the fan. SMACNA has cataloged the effect for various fan discharge arrangements (SMACNA HVAC Systems Duct Design Manual), but the magnitude of the effect in real systems is largely unknown.

To avoid system effect, fans should discharge into duct sections that remain straight for as long as possible, up to 10 duct diameters from the fan discharge to allow flow to fully develop. Where this is not possible, the effect can be minimized by:

- Orienting the fan so that an elbow close to the discharge bends in the direction of the fan rotation. Figure 36 shows how the opposite arrangement results in significant system effect.
- Discharging the fan into a large plenum then tap duct mains into the plenum with conical taps in situations like Figure 36 where poor discharge arrangement is unavoidable. Although this discharge will waste the fan’s velocity pressure, it will typically have a net lower energy impact than a poor discharge, and the plenum will reduce fan noise.

Figure 37 shows measured data for a system that suffers from both fan and duct system effect. The fan discharges directly into a sound trap, which was cataloged at 0.25" pressure drop at the rated airflow but actually creates a 1.2' pressure drop. The pressure drop resulting from the velocity profile off the fan is not symmetrical and most of the airflow goes through only one section of the sound trap. The air then goes directly into an elbow with a tap just below the throat of the elbow. Because the streamlines at the exit of the elbow are all bunched to the right side, the pressure drop through the tap and fire/smoke damper is over 0.5" compared to a pressure drop calculated from SMACNA data with less than half that value. Removing the sound trap to separate the fan discharge further from the elbow, and using a shorter radius elbow with splitters to separate the elbow discharge further from the riser tap would have improved the energy performance of this system. Sound levels would likely have been better as well since the system effect losses through the trap caused the fan to operate at much higher speed and sound power levels than it would with the sound trap removed. Another option would have been to discharge the fan into a large plenum then tap the riser into the bottom of the plenum.

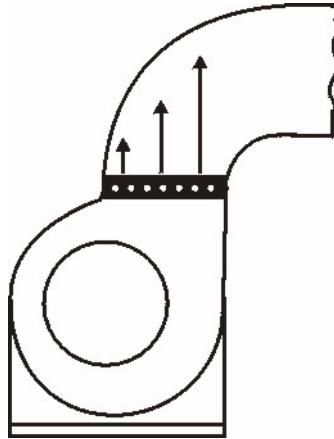

Figure 36. Poor Discharge Configuration Resulting in Significant Fan System Effect

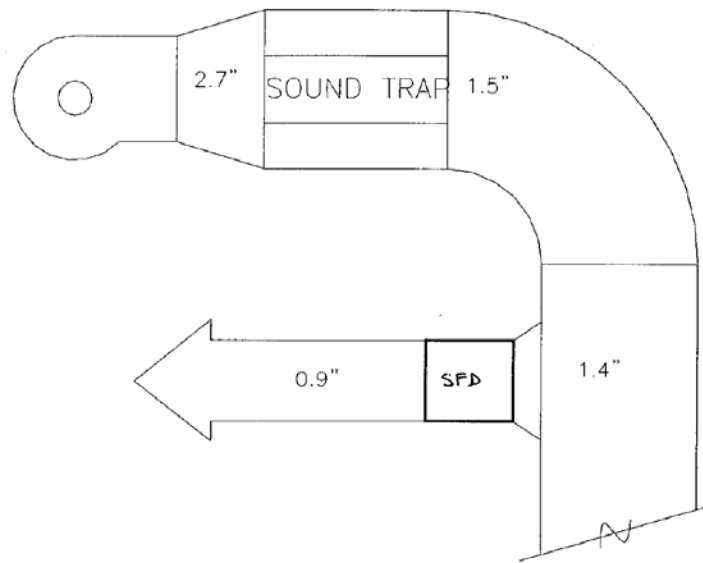

Figure 37. Measured Pressure in a System with Significant Fan and Duct System Effect

Noise Control

Air distribution system noise can be controlled by one or both of the following strategies:

1. Reduce sound power levels at the source (the fan and turbulence in duct systems).
2. Attenuate sound generated by the noise sources.

Typically both issues must be addressed. Reducing source sound power is generally the most efficient, and sometimes results in the lowest first costs.

Sound power can be reduced by considering:

- **Fan selection.** Different fan types have different acoustic performance and the selection of the fan size (wheel diameter) will also affect performance. See Fan Selection Criteria.
- **Pressure drop.** Lowering the system pressure drop allows for lower fan speed which lowers sound power levels. The largest pressure drops are from coils, filters, and dampers, which can be easily reduced by reducing face velocities, although often at high costs. Duct fittings are the next biggest cause of both pressure drop and of noise due to turbulence. These effects can be reduced by minimizing the number of fittings and by proper fitting design as discussed under General Guidelines.

- **Terminal selection.** VAV boxes and air terminals can be noisy but it is relatively easy to avoid problems by following selection procedures from manufacturers and in this document (see “Sizing VAV Reheat Boxes”). Attenuation measures include locating noisy equipment well away from noise-sensitive spaces which reduces noise levels, usually at low cost. Duct lines and attenuator are other strategies for attenuation and are discussed in more detail below.

Duct Liners

Fiberglass duct liner has been used for many years in HVAC duct distribution systems. Until recently, most engineers would not think twice about using duct liner for sound attenuation. But more and more the use of liner is being questioned by indoor air quality specialists and IAQ-conscious design engineers because of some potential problems associated with the product or its application:

- Duct liner can retain both dirt and moisture and thus may be a breeding ground for microbial growth. The problem occurs primarily where humidity is very high for long periods of time or where liquid water is present, such as at cooling coils or humidifiers.
- The binding and air-surface facing of duct liner has been found in some cases to break down over time and ends up being blown into occupied spaces as a black dust.
- Where facing and binding have broken down or been damaged, or at poorly constructed liner joints, fiberglass strands can break free and transferred to occupied spaces. Studies to date have shown that fiberglass used in duct liner is not carcinogenic, but it is still irritating to the skin.
- While dust can collect on any surface in a duct system, including sheet metal ducts, cleaning duct liner can be more difficult than other surfaces because its rough surface traps dirt in crevices and because it is more easily damaged by mechanically cleaning equipment such as brushes.

The jury is still out as to how significant these problems truly are. Clearly, some buildings have had major problems that have been attributed at least in part to duct liner, particularly issues with microbial growth in humid climates. But many more buildings that have considerable lengths of lined duct are apparently “healthy.” Still, publicity about potential problems and concerns about litigation are leading design engineers to look for alternative products and designs to avoid, or at least mitigate, the use of duct liner.

But for sound attenuation, there are no simple substitutions for the benefits of duct liner. Alternative designs and products are almost always more expensive, take up more space, and use more fan energy due to increased pressure drops.

Options to attenuate noise in lieu of fiberglass duct liner include:

- **Sound traps.** While widely mentioned as an alternative, sound traps usually contain fiberglass and can harbor dirt and moisture just as readily as liner. Using a foil or plenum rated plastic facing can protect the fiberglass or packless traps can be used to avoid the fiberglass entirely but at extra cost and reduced effectiveness.
- **Plenums.** Abrupt discharge and intake plenums are effective at attenuating sound even when unlined. However, they can increase pressure drop.
- **Alternative liner materials.** Materials other than fiberglass liner are available, such as closed cell foam. While they may avoid some of the problems with fiberglass liner, they are usually less effective at sound attenuation.

In many, perhaps most, buildings, there simply is not enough space or not enough budget available for these options to be implemented. Fiberglass liner may still be best or the only viable option. Fortunately, the potential problems of duct liner can be at least partially mitigated by covering it with a protective material like:

- **Perforated metal facing.** Like sound traps, perforated liner is commonly considered a good way to mitigate the problems of duct liner, but it too can still trap dirt and moisture and air is still exposed to fiberglass. Foil or other facings can be used inside the perforated liner to protect the fiberglass.
- **Foil and non-metallic facing.** The acoustical benefits of duct liner can be partially retained with foil and non-metallic facing films. These are standard options on most VAV boxes.
- **“Tough” facing.** Most liner manufacturers are producing liner with much more resilient facing/binding materials designed to resist breakdown and damage to mechanical cleaning.
- **Biostats.** Liner can be treated with biostats to resist microbial growth. However, once the biostat is covered with a film of dirt, its effectiveness may be reduced.

Finally, problems with liner can be minimized by locating it where a problem is less likely to occur:

- **“Wet” sections.** Avoid locating liner where it will be in direct contact with liquid water such as at cooling coils and downstream of humidifiers. Most air handlers and many large rooftop AC units can be specified with solid double wall construction in the cooling coil sections to avoid insulation having direct contact with coil frames and condensate pans.
- **Filters.** Placing filters upstream of duct liner minimizes the liner’s exposure to dirt, keeping it cleaner longer. Filters can also be located downstream of liner to prevent degrading facing, binding materials, or fiberglass from being supplied to the space.

All in all, designing HVAC systems without duct liner is a major challenge and often an expensive one. The best designs may be those that use duct liner only where needed for sound attenuation, that locate it in clean and dry areas, and that protect it as best as possible from damage and erosion with protective facings.

The following guidelines are recommended for duct liner:

- Liner should be limited to the amount required for adequate sound attenuation. Advice from an acoustical engineer, and perhaps some time and experimentation, will be needed to determine exactly how much lining is actually necessary. Typically, liner is only needed in fan discharge and inlet plenums, in main duct risers for a story or two, and in VAV boxes. Duct mains on floors up to and after VAV boxes (other than the box's discharge plenum) are generally unlined.
- Liner should not be located in "wet sections" of air handlers (coil sections, humidifier sections) where the manufacturer has an option for solid double-wall construction in these sections. (This is not yet a common option on smaller air handlers and fan-coils, unfortunately.)
- "Tough" liner facings should be specified to improve resistance to erosion and damage.
- In large air handlers where insulation may be damaged by personnel working around it, perforated double wall construction should be specified.
- Liner must be required to be protected from weather during construction and replaced if it becomes wet.

Supply Air Temperature Control

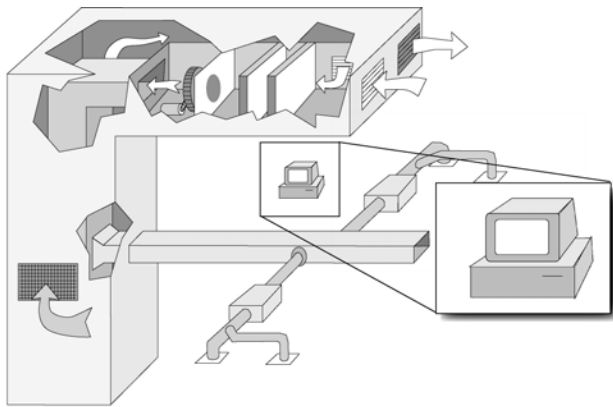

- Optimal Supply Air Temperature
- Recommended Sequence of Operation
- System Design Issues
- Code Requirements

In most buildings the optimal setting for supply air temperature varies over time, often from one hour to the next, and supply air temperature reset controls can provide significant energy savings. This section describes some of the important design issues related to supply air temperature control and includes recommended control sequences.

Optimal Supply Air Temperature

The optimal supply air temperature minimizes the combined energy for fan, cooling, and heating energy. But this is a fairly complex tradeoff, and the optimal setpoint at any point in time is not obvious.

Simulation can provide some insight into an optimal control strategy. Figure 38 and Figure 39 illustrate results for the Sacramento climate on two different days, one hot and the other mild. In both figures, the top three charts show snapshots in time with energy consumption plotted as a function of supply air temperature. These show, as expected, that as supply air temperature increases, the fan energy goes up and cooling energy drops. On the hot day (Figure 38), the supply air temperature that minimizes the total HVAC electricity changes from 60°F in the morning to 50°F in the afternoon. At midday, it's nearly a toss-up where 55°F is optimal but results are very close to those at 50°F and 60°F. The lower three graphs show hourly results over the course of the day.

On the mild day, illustrated in Figure 39, the best choice is 60°F throughout the day because it significantly reduces the amount of cooling energy with only a small increase in fan energy. The 60°F setpoint also results in lower reheat energy.

These results illustrate the following general guidelines:

- Use supply air temperature reset controls to avoid turning on the chiller whenever possible. The setpoint should be the highest temperature that can still satisfy the cooling demand in the warmest zone. Ideally, no chiller operation will be required until outdoor air reaches somewhere between 60°F and 65°F. The warmer supply air temperatures in cool and cold weather also reduces reheat at the zone level.
- Continue to use supply air reset during moderate conditions when outdoor air temperature is lower than about 70°F. In this range, the outdoor air is still providing a portion of the cooling and it is worth spending a little extra fan energy to offset part of the chiller demand.
- Reduce the supply air temperature to its design setpoint, typically 53°F to 55°F, when outdoor air temperature exceeds 70°F. At these warmer temperatures, the outdoor air is providing little or no cooling benefit, and it is unlikely that any zones will require reheat.

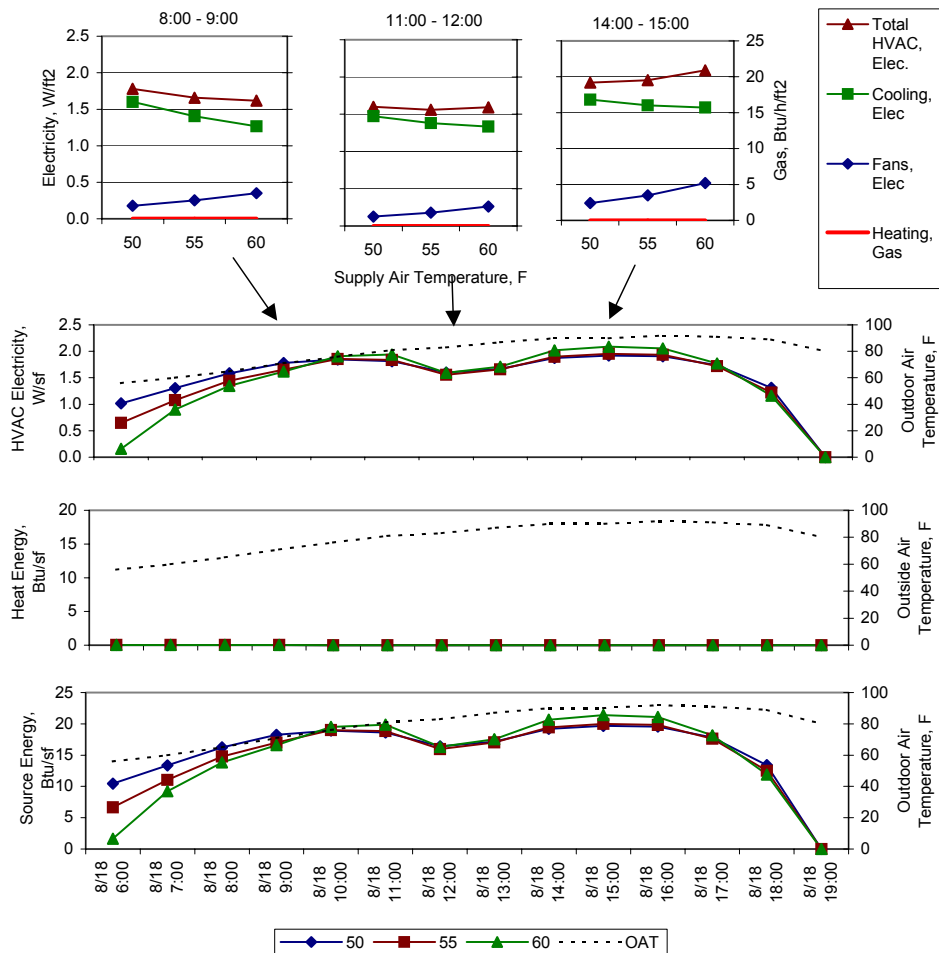

Figure 38. Comparison of Hot Day Simulation Results for Three Supply Air Temperature Setpoints: 50°F, 55°F, and 60°F. August 18. Sacramento Climate.

The top three charts show HVAC electricity and gas consumption at three snapshots in time. The bottom three show hourly profiles for electricity, gas and source energy consumption.

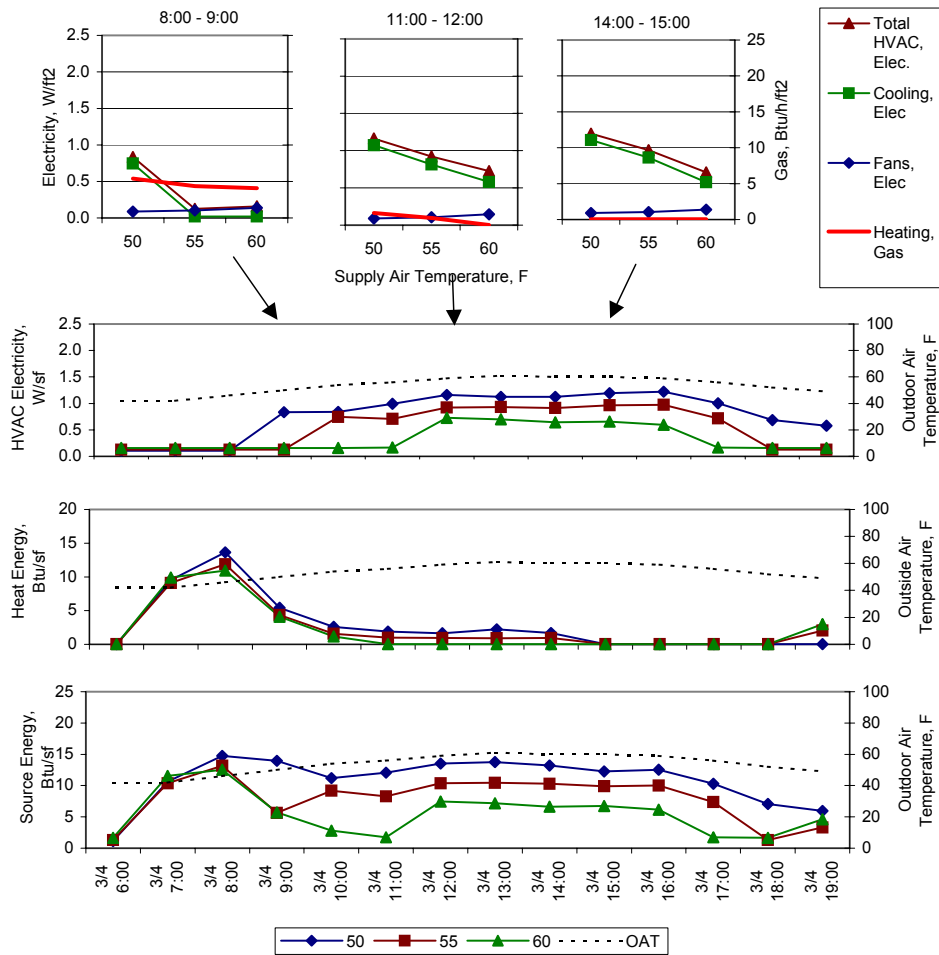

Figure 39 – Comparison of Mild Day Simulation Results for Three Supply Air Temperature Setpoints: 50°F, 55°F, and 60°F. March 4, Sacramento Climate.

The top three charts show HVAC electricity and gas consumption at three snapshots in time. The bottom three show hourly profiles for electricity, gas and source energy consumption. The assumptions in the simulation are detailed in Appendix 6 – Simulation Model Description.

Recommended Sequence of Operation

The recommended control sequence is to lead with supply temperature setpoint reset in cool weather where reheat might dominate the equation and to keep the chillers off as long as possible, then return to a fixed low setpoint in warmer weather when the chillers are likely to be on. During reset, employ a demand-based control that uses the warmest supply air temperature that satisfies all of the zones in cooling.

Supply air temperature setpoint:

During occupied mode, the setpoint is reset from T-min (53°F) when the outdoor air temperature is 70°F and above, proportionally up to T-max when the outdoor air temperature is 65°F and below. T-max shall range

from 55°F to 65°F and shall be the output of a slow reverse-acting PI loop that maintains the Cooling Loop of the zone served by the system with the highest Cooling Loop at a setpoint of 90%.

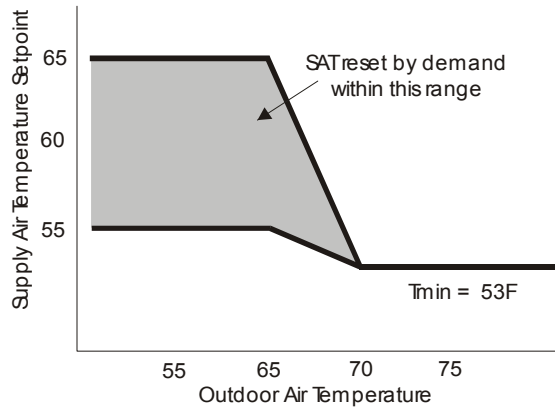

Figure 40. Recommended Supply Air Temperature Reset Method

System Design Issues

Supply air temperature reset is usually a good idea in all California climates, though there are some conditions where there will be limited benefit. Table 18 lists some factors affecting the potential for energy savings.

Table 18. Conditions Affecting the Impact of Supply Air Temperature Reset

Conditions Favoring SAT Reset	Conditions that Reduce the Savings Potential for SAT Reset
Mild climate with many hours below 70°F.	Dehumidification is necessary (typically not an issue for California office buildings).
VAV box minimum air flow setpoints of 30% or higher.	Hot climate with few hours below 60°F.
Low pressure loss air-side design, meaning there is less penalty from higher airflow.	Inefficient air-side system.
Skilled operating staff to maintain controls.	Constant cooling loads that cannot be isolated with a separate system.
Time varying levels of occupancy and interior heat gain.	Efficient part load fan modulation such as that provided by variable speed drives.

Supply air temperature reset is more than just an operational issue. There are several important system design issues to consider to ensure that temperature reset can be implemented successfully.

- Size interior zone air flows so that the likely peak loads can be met at air temperatures higher than the minimum design temperature. This allows reset to occur during cool weather and reduces reheat necessary in perimeter zones while still satisfying cooling needs of interior zones.
- Provide DDC control to the zone level with feedback regarding temperature and setpoint from each zone.
- Use a separate cooling system for unique loads such as computer centers so that they do not force the whole building system to operate at a low fixed temperature.

- Maximize air distribution system efficiency through supply air pressure controls and low-pressure loss design. This strategy reduces the energy penalty for increased air flow when supply air temperature is reset upwards.
- Integrate the sequence of operations with supply air pressure reset control. In the method described below, supply air temperature is reset based on a combination of outdoor temperature and zone cooling demand, while the recommended supply pressure controls are based on VAV box damper position (see “Static Pressure Reset”).
- Include a clear specification for the sequence of operations.
- Include commissioning requirements in the specifications. Reset controls can be highly unstable unless well tuned.

Code Requirements

Supply temperature reset is required by Title 24 for one-fourth of the difference between the supply design temperature and the design space temperature. For example, if the system design leaving temperature is 54°F and the design space temperature is 74°F, $20^{\circ}\text{F}/4=5^{\circ}\text{F}$ of reset (from 54°F to 59°F) is required.

In 2005, reset will no longer be required by Title 24 for VAV systems with variable speed driven fans. This is because variable speed drives are so effective at reducing fan energy at low airflow rates that the fan energy savings resulting from low supply air temperatures offset the savings in reheat energy resulting from higher supply air temperatures. Although no longer required by the energy code, supply temperature setpoint reset as detailed in this section is still cost effective even with variable speed drives.

Fan Type, Size and Control

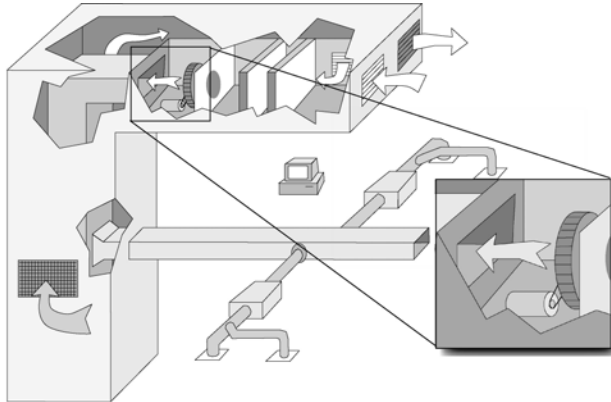

- Fan Selection criteria
- Visualizing Fan Performance
- Fan Selection Case Studies
- Comparing Manufacturers
- Fan Control
- Conclusions

This section This section discusses how to select fans for typical large VAV applications. Information includes the best way to control single and parallel fans, as well as presentation of two detailed fan selection case studies.

Fan Selection Criteria

The factors to consider when selecting a fan include:

- **Redundancy** – a single fan or multiple fans.
- **Duty** – CFM and static pressure at design conditions.
- **First cost** – more efficient fans are often more expensive.
- **Space constraints** – a tight space may limit fan choices.
- **Efficiency** – varies greatly by type and sizing.
- **Noise** – different fan types have different acoustic performance.
- **Surge** – some fan selections are more likely to operate in surge at part-load conditions.

These issues are elaborated on below and in the case studies that follow.

Redundancy

One of the first questions to answer when selecting a fan is whether to use a single fan or parallel fans. The primary advantage of parallel fans is that they offer some redundancy in case one of the fans fails or is down for servicing. Parallel fans are sometimes necessary because a single fan large enough for the duty is not available or because a single fan would be too tall. Of course, parallel fans can also create space problems (e.g., two parallel fans side-by-side are wider than a single fan). Parallel fans are also more expensive and create more complexity in terms of fan control and isolation (as discussed below).

Type

Fans are classified in terms of impeller type (centrifugal, axial, mixed flow), blade type, and housing type. See Table 19. Fan Classification.

The first step when selecting a fan type is to limit the choices based on the application. For example, for medium to large supply or return fans (e.g., >30,000 CFM), the top choices include housed airfoil and plenum airfoil centrifugal fans, but may also include multiple forward curved centrifugal fans or mixed flow fans.²⁸ For small systems (<15,000 CFM), forward curved fans are generally the optimum choice due to low first costs. All these fan types are possible in the middle size range.

²⁸ Vane-axial fans were once a common option as well when variable speed drives were new and expensive because they were very efficient at part load, but they are seldom used anymore due to high first costs, the need for sound traps on inlet and outlet, and high maintenance costs for variable pitch fans. Vane-axial fans were therefore not considered in our analysis.

Table 19. Fan Classification

CENTRIFUGAL (flow radial to fan shaft)
Blade Type
Backward Inclined
Straight/Flat Blade (BI)
Air Foil (AF)
Radial – (typically only for industrial applications)
Forward Inclined
Straight/Flat Blade
Forward Curved
Housing Type
Scroll Type (housed fan)
Single Width (ducted inlet from one side)
Double Width (air enters from two sides)
Plug Type
In-line (tubular)
Roof-top (dome) – (used for low static exhaust)
Plenum
AXIAL (flow parallel to fan shaft)
Blade Type
Slanted Blades
Air Foil
Cambered Twist
Housing Type
Propeller – (common for relief, low pressure exhaust)
Tube-axial
Vane-axial
Fixed Pitch
Adjustable Pitch
Variable Pitch
MIXED FLOW (hybrid – part centrifugal and part axial)
Blade Type
Contoured Single Thickness
Air Foil
Housing Type
In-line (tubular)

With large built-up systems and custom units, the designer's first choice should be a housed airfoil centrifugal fans. This is the most efficient fan type and, for built-up systems when the cost of the discharge plenum is included, a housed fan system will generally be less expensive than a plenum fan system. The major disadvantage of housed airfoil fans is noise; they generate high sound power levels in the low frequency bands which are very difficult to attenuate.

If the housed airfoil fan will not fit or meet the acoustic criteria, the next choice should be a plenum or mixed flow fan. In terms of efficiency, the housed airfoil fan is the best followed by the mixed flow fan. The plenum fan is the least efficient choice

for medium pressure systems unless space constraints would cause a housed fan to be installed in a manner that would lead to high system effects.

The characteristic of the fan types now most commonly used for VAV supply fan applications are summarized in the Table below.

Table 20. Comparison of Common VAV Supply Fan Types

Fan Type	Typical Applications	First Cost	Space Constraints	Efficiency	Noise	Other
Housed forward-curved (FC) centrifugal	CFM <25000 1" <SP<3.5"	Lowest	Requires more space than plenum fans for smooth discharge	Least efficient than housed airfoil for >3", better or same as housed airfoil, BI for <2"	Slower speed than housed airfoil so usually quieter.	Small surge region; may be unstable for parallel fans at low airflow, high static.
Housed backwardly inclined (BI) centrifugal	CFM <70000 2" <SP <6"	Medium Low	Requires more space than plenum fans for smooth discharge	Somewhat less than housed airfoil.	Similar to housed airfoil.	Larger surge region than housed airfoil.
Housed airfoil (AF) centrifugal (double width).	CFM <100000 2" <SP <8"	Medium	Requires more space than plenum fans for smooth discharge	Highest efficiency.	Noisier than plenum and forward-curved	Small surge region; high shut off pressure.
Mixed flow	CFM <60000 2" <SP <6"	Highest	Good for inline use.	Similar to housed airfoil but drops off in surge region.	Quieter than other housed fans.	Small surge region.
Plenum airfoil centrifugal	CFM <80000 2" <SP <6"	High. Cost of discharge plenum also must be included	Requires least space, particularly for multiple fans	Lower efficiency than housed airfoil unless space is constrained.	Quietest when plenum effects included	Large surge region.

Fan Pressure Ratings

There is a great deal of confusion regarding the issue of fan total pressure drop versus fan static pressure drop. This section attempts to clarify the issue of total versus static pressure. The work that a fan must do is proportional to the total pressure rise across the fan. Total pressure consists of velocity pressure and static pressure. The total pressure rise across a fan is:

$$\begin{aligned}\Delta TP &= TP_{LEAVING} - TP_{ENTERING} \\ &= SP_{LEAVING} + VP_{LEAVING} - SP_{ENTERING} - VP_{ENTERING}\end{aligned}$$

Most vane-axial fans are rated based on total pressure drop. However, most other fans types (e.g., centrifugal fans) are not due to historical standard rating practices. It is important to find out from the manufacturer's catalogue under what conditions the fan ratings were developed.

Centrifugal fans are typically rated using a combination of inlet and outlet static and velocity pressures defined as follows:

$$\begin{aligned}SP_{rating} &= TP_{LEAVING} - TP_{ENTERING} - VP_{LEAVING} \\ &= SP_{LEAVING} - SP_{ENTERING} - VP_{ENTERING}\end{aligned}$$

This very confusing rating criterion is usually called the "fan static pressure" because it is equal to the static pressure rise across the fan when the inlet velocity pressure is zero, which is the condition when the fan inlet is in an open plenum (velocity = 0) as is the case when the fan rating test is performed. To confuse matters further, it is also often called the "total static pressure" to differentiate it from the "external static pressure," which is the pressure drop external to a packaged air handler or air conditioner (i.e., the total static pressure drop less the pressure drop of components within the air handler).

As noted under Duct Design, it is difficult to accurately calculate the total pressure drop at design conditions, so engineers typically estimate or "guesstimate" the design pressure drop. Therefore, it does not really matter that the fans are rated in this confusing manner because the drop calculation is an education guess in most cases.

Where total versus static pressure becomes important is when comparing housed centrifugal fans versus plenum fans or axial fans. Housed fans are nominally more efficient because they use the housing to concentrate all the air coming off of the wheel into a small area, which creates higher static pressure at the outlet (leading to higher efficiency) but also higher velocity pressure. If this velocity pressure is dissipated by poorly designed elbows and other fittings at the fan discharge, then a housed fan can actually be less efficient than a plenum fan in the same application because it is operating against a higher total external pressure. A plenum fan is primarily creating static pressure in a pressurized plenum and is less vulnerable to system effects due to high velocities at the discharge.

Visualizing Fan Performance

Fan curves and selection software provided by the manufacturers give a lot of useful information about fan performance. However it is hard to visualize the operation of a fan across the full range of operating conditions using a typical manufacturer's fan curve. In particular, the challenge is in determining the fan efficiency at any point other than the design condition. Figure 41 shows a fan selection for a 60" plenum fan. The data in the upper left hand corner indicates that the fan has a 63% static efficiency at the design point.

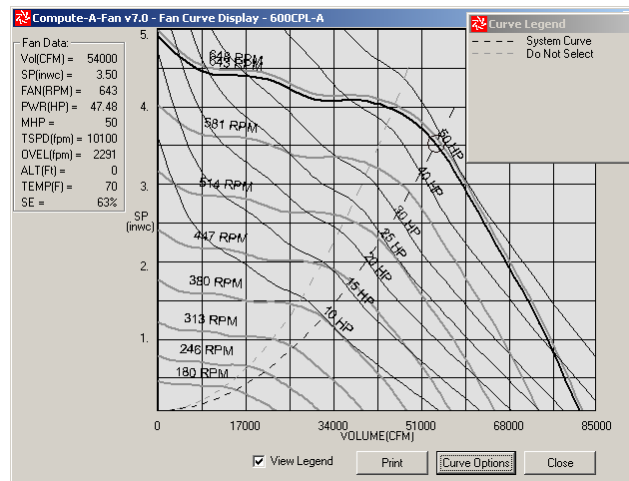

Figure 41. A Typical Manufacturer's Fan Curve (60" Plenum Fan)

While developing the Guidelines, the authors developed the Characteristic System Curve Fan Model (Hydeman and Stein, January, 2004), which can be used to develop three dimensional fan curves. These curves add fan efficiency to the z-axis on top of the pressure (y-axis) and volume (x-axis) of the manufacturer's curve. Figure 42 shows a 66" plenum airfoil fans and Figure 43 shows a 49" housed airfoil fan. Looking at Figure 42 and Figure 43, it is easy to see the breadth of the high efficiency region for the airfoil fan across a range of operating conditions.

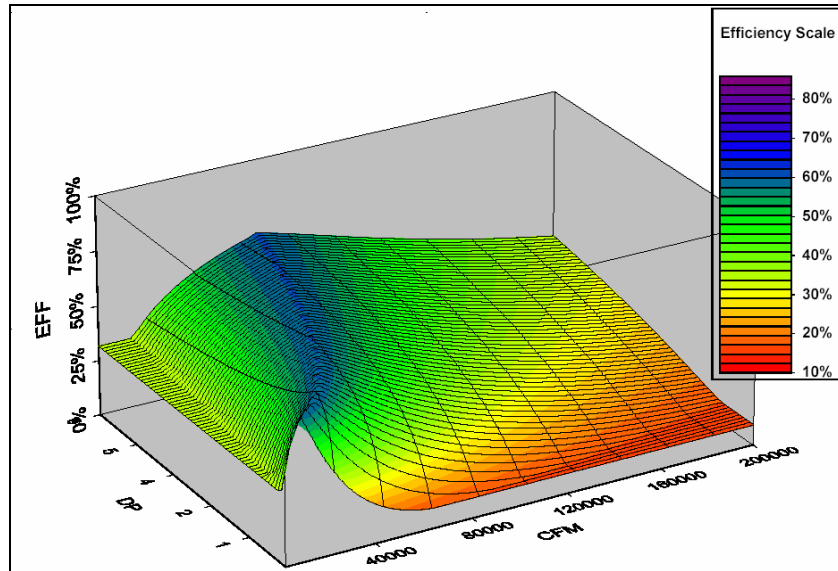

Figure 42. Three-Dimensional Fan Curve for 66" Plenum Airfoil Fan

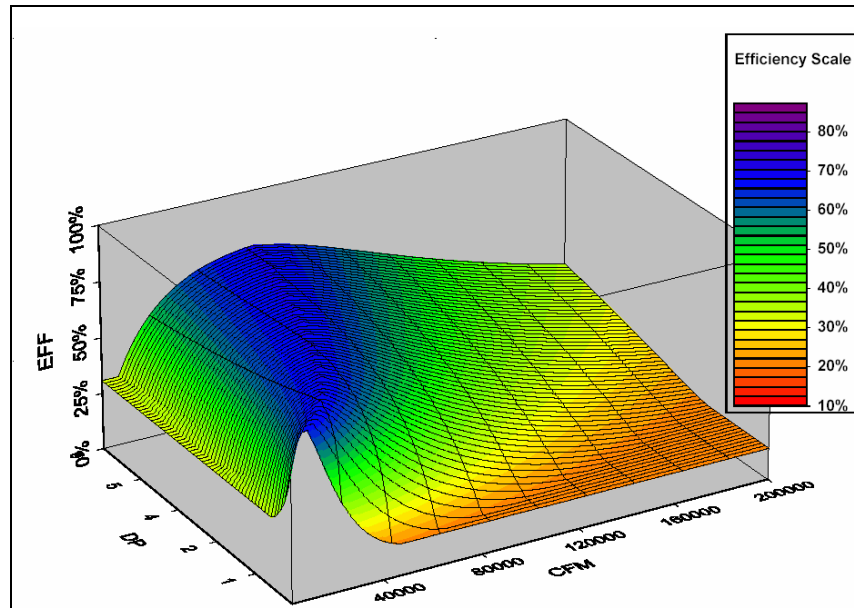

Figure 43. Three-Dimensional Fan Curve for 49" Housed Airfoil Fan

Another way of evaluating and comparing fans is to look at “Gamma Curves”. Any point in fan space (CFM, SP) is on a characteristic system curve (a parabola through that point and through the origin). Each characteristic system curve is defined by a unique system curve coefficient (SCC), which can be calculated from any point on that characteristic system curve. Gamma (γ) is defined as the negative natural log of SCC. (Gamma is easier to view on a linear scale than SCC.)

$$SCC = \frac{\Delta P}{CFM^2} \quad \gamma \equiv -\ln(SCC)$$

Figure 44 is the gamma curve for Cook 60" plenum airfoil fan (600CPL-A). One of the useful features of a gamma curve is that it collapses all of the performance data for a fan into a single curve that can be used to calculate fan efficiency at any possible operating condition. For example, the point 89,000 CFM and 6" w.c. has a gamma value of 21 which corresponds to a fan efficiency of 55%. Similarly, the point 63,000 CFM and 3" w.c. also has a gamma value of 21 and a fan efficiency of 55%. Gamma curves can be developed using a handful of manufacturer's data points and then used to quickly compare several fan types and sizes (see Figure 45 and Figure 46). Figure 46, for example, shows three sizes of plenum fans. It also shows that the 49" housed airfoil is more efficient than any of these plenum fans under any operating conditions. Gamma curves are also useful for seeing the relationship between the peak efficiency and the surge region. For plenum fans, for example, the peak efficiency is right on the border of the surge region (see Figure 45). For airfoil fans, however, the peak efficiency is well away from the surge region (see Figure 45 and Figure 47).

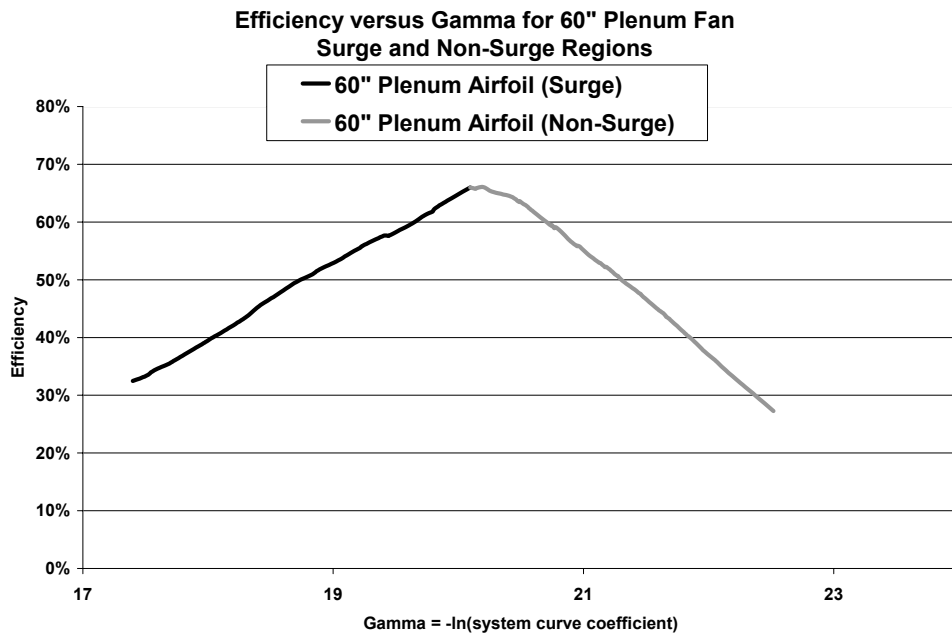

Figure 44. Gamma Curve

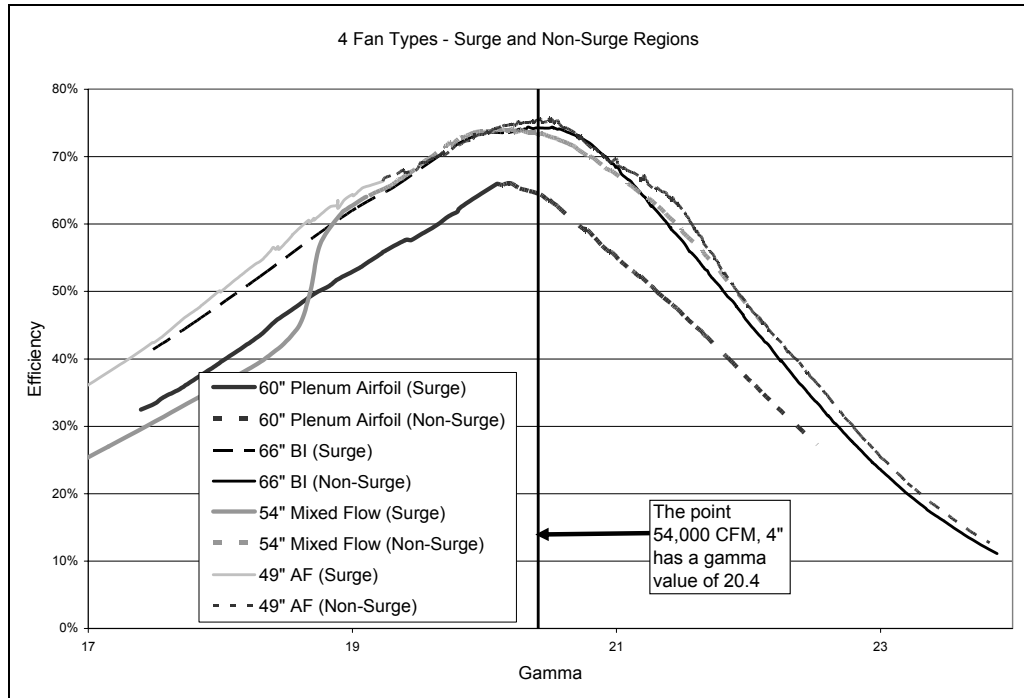

Figure 45. Gamma Curves for Four Fan Types

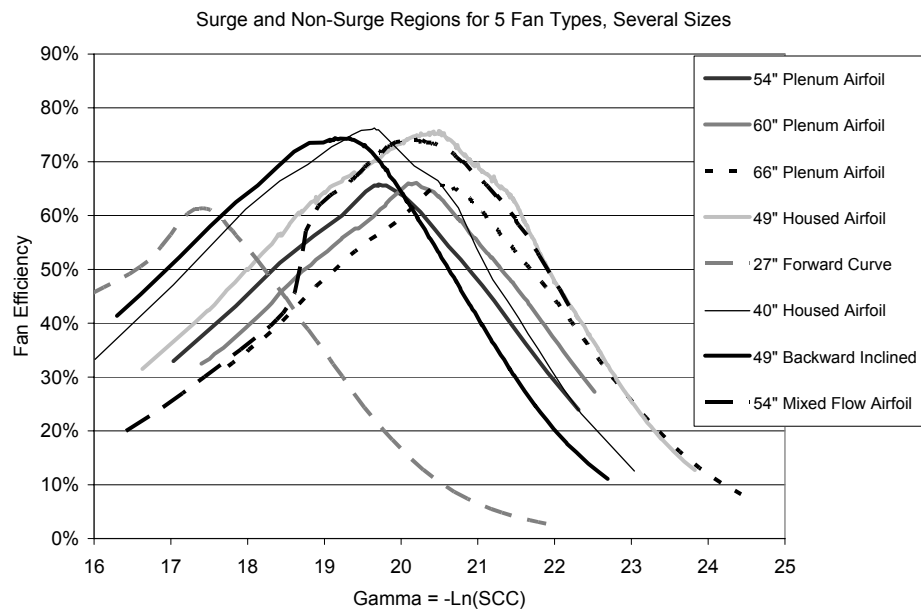

Figure 46. Gamma Curves for Several Fan Types and Sizes

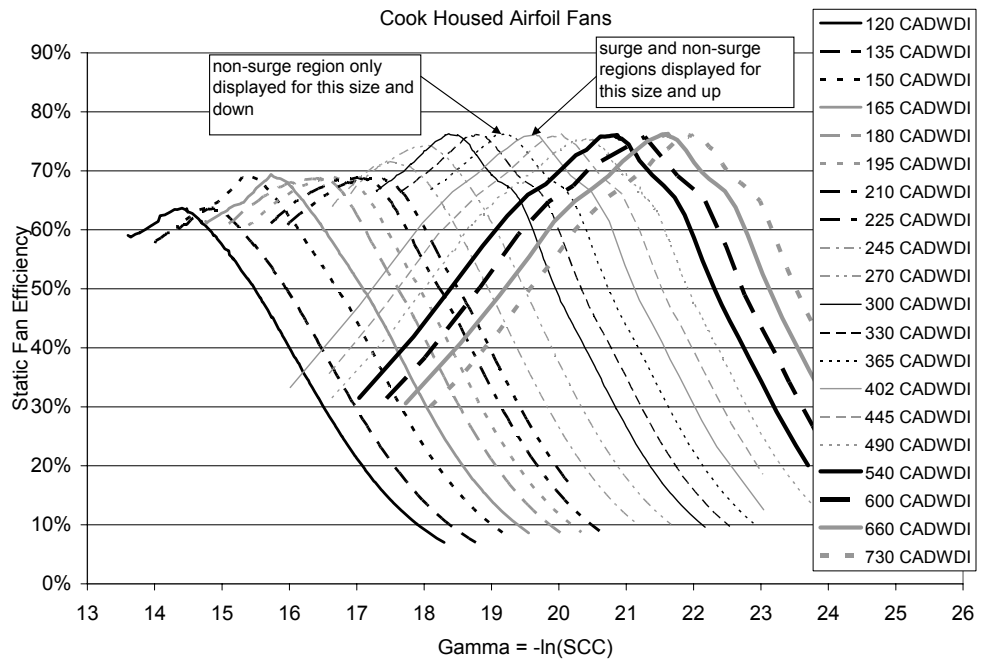

Figure 47. Gamma Curves for All Cook Housed Airfoil Fans

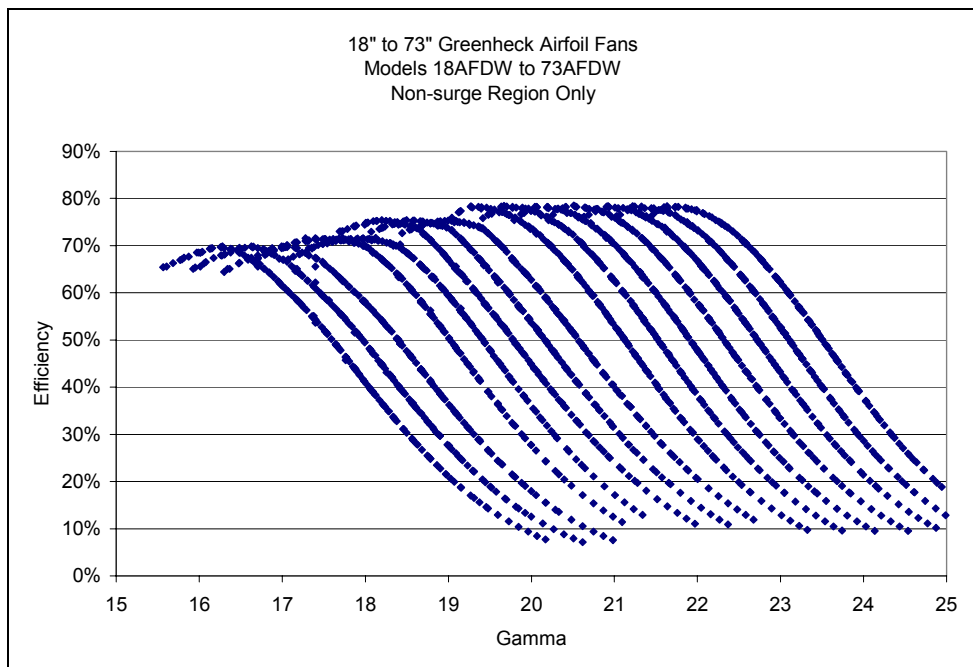

Figure 48. Gamma Curves for All Greenheck Housed Airfoil Fans (Non-Surge Region Only)

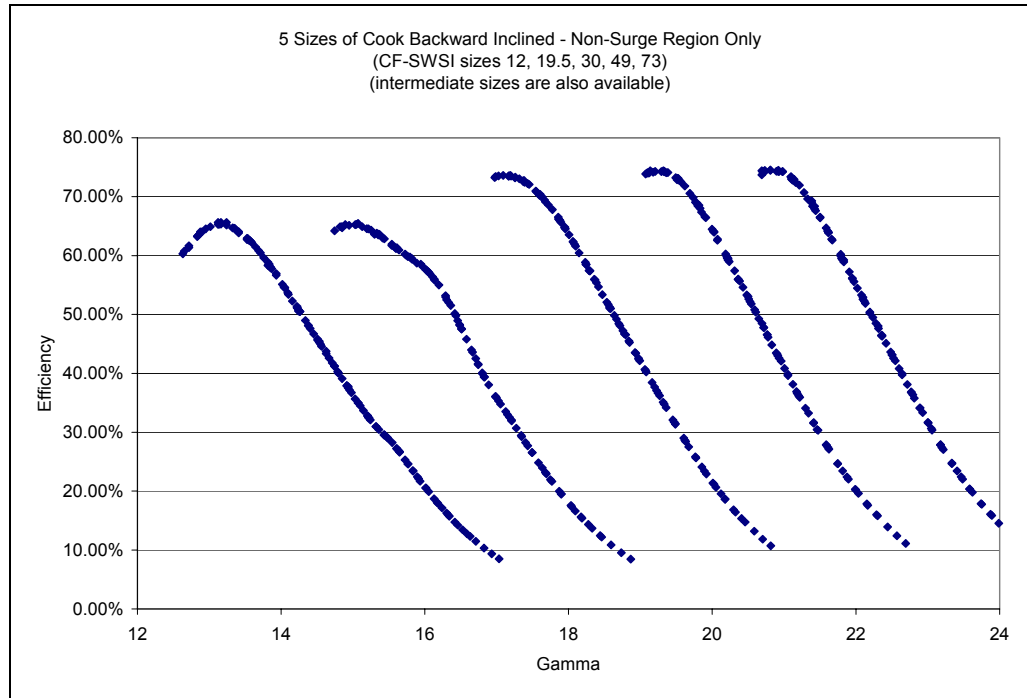

Figure 49. Gamma Curves for Some Cook Backward Inclined Fans

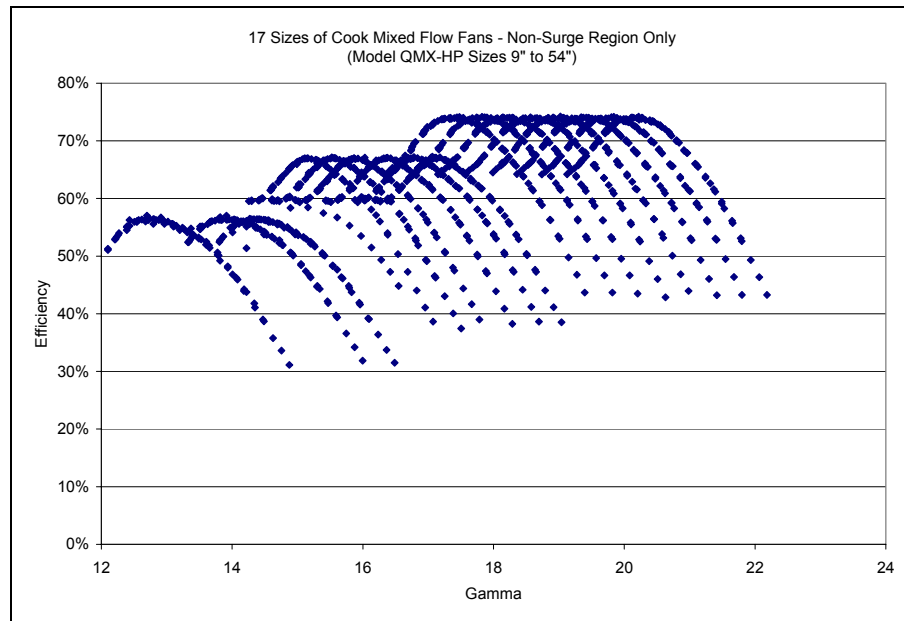

Figure 50. Gamma Curves for All Cook Airfoil Mixed Flow Fans

Fan Selection Case Studies

This section walks through the process that an engineer is likely to go through when selecting a fan for a typical built-up air handler. The issues are generally similar for large packaged or custom units but the choices of fan types and sizes are likely to be limited by the air handler manufacturer. In this section, two supply fan case studies illustrate some of issues:

Case Study	Design Condition	Num. Fans	Fan Types Compared
A	54,000 CFM at 4"	1	Housed Airfoil, Plenum, BI, Mixed Flow
B	145,000 CFM at 4"	2	Housed Airfoil, Plenum

Several conclusions can be drawn from these case studies:

1. Use housed airfoil fans where they meet space and noise constraints. These fans are generally more efficient and less likely to operate in surge than plenum fans. They are also generally less expensive than plenum or mixed flow fans.
2. Control fans using static pressure setpoint reset (see discussion below). This can save up to 50% of the fan energy compared to a fixed setpoint static control. It will also greatly reduce the operation of fans in surge, which can lead to accelerated bearing wear.
3. For multiple fan systems, stage fans based on the pressure control scheme shown in Figure 84 and Figure 85.

Case Study A

The first case study is a hypothetical example with a relatively small fan for which four types of fans are available. The first step is to use manufacturer's software to compare the efficiency at the design point, and to compare first cost, motor size, and acoustics. It is important to look not just at the fan cost, noise, efficiency, and motor size, but also at the fan curve and where the design point lies relative to the surge line, which is often labeled "Do not select to the left of this line." Different fan types have fundamentally different relationships between peak efficiency and surge. Housed airfoil fans, for example, have their peak efficiency well to the right of the surge line. Plenum fans, however, are at their highest efficiency right at the surge line.

Figure 51 shows the Loren Cook choices for housed airfoil (Model CADWDI) and housed backward inclined (Model CF). Figure 52 indicates the Cook choices for plenum airfoil (CPL-A) and airfoil mixed flow (QMX-HP). Each of these figures has two separate tables. The top table shows data for a number of fans that will meet the design criteria, including the model number, the design airflow (cfm), the design static pressure, the brake horsepower, the recommended motor horsepower, the fan speed (rpm), the static efficiency (SE), the weight, the relative cost, a budgetary price, an estimation of the annual operating costs, and a payback. The operating costs are based on assumptions built into the manufacturer's software that should be taken with a large grain of salt. Assumptions on static pressure control alone can have up to a 50% decrease in annual energy usage. The bottom table presents wheel

size, construction class, and sound power data for the same fans. As reflected in these figures, the plenum fans have considerably lower static efficiency (SE) than the other types.

Compute-A-Fan v7.0 - Select By Application

Model	Volume CFM	SP inwc	Power HP	Motor HP	RPM	SE	Weight lbs	Relative Cost	Budget Price	Operate Cost/Yr	Payback (Years)
300CADWDI	54000	4	85.8	100	1850	40%	1440	1.45	\$9,900	\$10,668	Never
330CADWDI	54000	4	70.7	75.0	1471	48%	1890	1.14	\$7,800	\$8,790	Never
365CADWDI	54000	4	56.9	60.0	1169	60%	2330	1.13	\$7,700	\$7,075	.99
402CADWDI	54000	4	50.5	60.0	972	67%	2850	1.30	\$8,800	\$6,279	1.17
445CADWDI	54000	4	47.4	50.0	816	72%	3570	1.29	\$8,800	\$5,893	.96
490CADWDI	54000	4	44.6	50.0	692	76%	4170	1.43	\$9,700	\$5,545	1.19
540CADWDI	54000	4	46.2	50.0	612	74%	5200	1.86	\$12,600	\$5,744	2.59
600CADWDI	54000	4	48.9	50.0	541	70%	6310	2.23	\$15,100	\$6,080	4.36
402 CF	54000	4	93.2	100	1475	36%	1405	1.84	\$12,500	\$11,588	Never
445 CF	54000	4	74.1	75.0	1141	46%	1740	2.02	\$13,700	\$9,213	Never
490 CF	54000	4	61.9	75.0	907	55%	1989	1.64	\$11,100	\$7,696	15.03
540 CF	54000	4	53.0	60.0	730	64%	2553	1.86	\$12,600	\$6,590	4.17
600 CF	54000	4	47.1	50.0	599	72%	3493	1.95	\$13,200	\$5,856	3.01
660 CF	54000	4	45.8	50.0	516	74%	4575	2.39	\$16,200	\$5,694	4.11

Nom IMPLR(in)	Class	OB1	OB2	OB3	OB4	OB5	OB6	OB7	OB8	LwA
30.0	III	110 /	116 /	115 /	107 /	103 /	102 /	99 /	95 /	111 /
33.0	II	109 /	113 /	113 /	102 /	100 /	98 /	95 /	90 /	108 /
36.5	II	100 /	106 /	107 /	98 /	96 /	93 /	87 /	82 /	103 /
40.2	II	100 /	105 /	102 /	96 /	93 /	89 /	83 /	79 /	99 /
44.5	I	100 /	104 /	98 /	94 /	91 /	86 /	80 /	75 /	96 /
49.0	I	102 /	102 /	94 /	92 /	88 /	83 /	78 /	74 /	94 /
54.0	I	103 /	100 /	94 /	92 /	87 /	82 /	78 /	74 /	94 /
60.0	I	103 /	99 /	94 /	92 /	87 /	82 /	78 /	75 /	93 /
40.2	III	111 /	115 /	116 /	107 /	104 /	103 /	101 /	95 /	112 /
44.5	III	109 /	111 /	108 /	103 /	100 /	99 /	96 /	89 /	107 /
49.0	II	108 /	108 /	102 /	99 /	96 /	95 /	91 /	83 /	103 /
54.0	II	105 /	106 /	97 /	95 /	93 /	90 /	84 /	76 /	98 /
60.0	I	103 /	100 /	95 /	92 /	90 /	86 /	79 /	71 /	95 /
66.0	I	103 /	98 /	95 /	91 /	89 /	85 /	77 /	69 /	94 /

Relative Cost and Budget Price (US \$) includes Fan, ODP motor and does not include accessories and drives. (3/4 hp and above assum
Operating cost (US \$) based on 12 hours/day, 250 days/year and \$.05 per kw/h. Right click on grid to change operating criteria.
AMCA Licensed for Sound and Air Performance. Power rating (BHP/kW) excludes drives.

Figure 51. Case Study A - Selection Software - Housed Airfoil and BI Choices

Compute-A-Fan v7.0 - Select By Application

Model	Volume CFM	SP inwc	Power HP	Motor HP	RPM	SE	Weight lbs	Relative Cost	Budget Price	Operate Cost/Yr	Payback (Years)
402CPL-A	54000	4	89.5	100	1525	38%	969	1.19	\$8,100	\$11,128	Never
445CPL-A	54000	4	73.4	75.0	1194	46%	1100	1.15	\$7,800	\$9,126	Never
490CPL-A	54000	4	64.2	75.0	962	53%	1263	1.00	\$6,800	\$7,982	..
540CPL-A	54000	4	58.7	60.0	817	58%	1562	1.09	\$7,400	\$7,298	.88
600CPL-A	54000	4	52.8	60.0	671	64%	1828	1.27	\$8,700	\$6,565	1.34
490QMx	54000	4	47.6	50.0	828	71%	3330	1.80	\$12,200	\$5,918	2.62
540QMx	54000	4	48.5	50.0	698	70%	3860	2.23	\$15,100	\$6,030	4.25
600QMx	54000	4	50.9	60.0	598	67%	4780	2.76	\$18,700	\$6,329	7.20
540QMx-HP	54000	4	46.3	50.0	730	73%	4000	2.43	\$16,500	\$5,757	4.36

Nom IMPLR(in)	Class	OB1	OB2	OB3	OB4	OB5	OB6	OB7	OB8	LwA
40.2	III	/ 108...	/ 114...	/ 113...	/ 108...	/ 108...	/ 105...	/ 97	/ 88	/ 112...
44.5	III	/ 106...	/ 110...	/ 108...	/ 105...	/ 103...	/ 98	/ 90	/ 83	/ 108...
49.0	II	/ 104...	/ 107...	/ 104...	/ 102...	/ 99	/ 92	/ 85	/ 79	/ 104...
54.0	II	/ 106...	/ 112...	/ 109...	/ 112...	/ 98	/ 94	/ 87	/ 82	/ 110...
60.0	II	/ 107...	/ 111...	/ 108...	/ 108...	/ 95	/ 90	/ 83	/ 79	/ 107...
49.0		91 / 94	94 / 100	92 / 97	90 / 95	86 / 90	83 / 86	79 / 83	74 / 82	92 / 97
54.0		92 / 95	92 / 98	90 / 95	88 / 92	84 / 87	81 / 83	77 / 83	73 / 84	90 / 95
60.0		93 / 95	91 / 97	89 / 94	86 / 91	83 / 86	80 / 82	77 / 86	73 / 87	89 / 94
54.0		93 / 98	97 / 99	92 / 95	89 / 92	84 / 87	81 / 83	76 / 82	71 / 83	91 / 94

Relative Cost and Budget Price (US \$) includes Fan, ODP motor and does not include accessories and drives. (3/4 hp and above assum
Operating cost (US \$) based on 12 hours/day, 250 days/year and \$.05 per kw/h. Right click on grid to change operating criteria.
AMCA Licensed for Sound and Air Performance. Power rating (BHP/kW) excludes drives.

Figure 52. Case Study A - Selection Software - Plenum and Mixed Flow Choices

In order to account for the fact that the plenum fans might have a lower total pressure drop due to reduced system effects, we reselected the plenum fans at a design condition of 3.5", rather than the 4" used for the other fan types (see Figure 53). This is a somewhat arbitrary assumption and assumes that 0.5" of the 4" of external pressure is due to system effects near the high velocity discharge of the airfoil, BI, and mixed flow fans. A plenum fan would not be subject to these system effects because of the low velocity pressure at the fan discharge. Figure 53 shows that the 66" plenum fan has the highest efficiency but the fan curve shows that the design point is too close to the surge region (see Figure 54). As this fan unloads, it is likely to operate in surge, particularly if it is controlled against a fixed static pressure setpoint (see discussion under case study B). Therefore, 60" is the best plenum choice (see Figure 55).

Compute-A-Fan v7.0 - Selected CPL-A Fans - BELT DRIVE

Model	Volume CFM	SP inwc	Power HP	Motor HP	RPM	SE	Weight lbs	Relative Cost	Budget Price	Operate Cost/Yr	Payback (Years)
402CPL-A	54000	3.5	84.6	100	1502	35%	969	1.29	\$9,700	\$10,519	Never
445CPL-A	54000	3.5	68.1	75.0	1169	44%	1100	1.25	\$9,400	\$8,467	Never
490CPL-A	54000	3.5	58.3	60.0	935	51%	1263	1.00	\$7,500	\$7,249	-
540CPL-A	54000	3.5	53.4	60.0	792	56%	1562	1.18	\$8,800	\$6,639	2.13
600CPL-A	54000	3.5	47.5	50.0	643	63%	1828	1.16	\$8,700	\$5,906	.89
660CPL-A	54000	3.5	45.3	50.0	554	66%	2428	1.32	\$9,900	\$5,632	1.48

Nom IMPLR(in)	Class	OB1	OB2	OB3	OB4	OB5	OB6	OB7	OB8	LwA
40.2	III	108	114	113	108	108	105	97	88	112
44.5	III	106	110	108	105	103	98	90	83	108
49.0	II	104	107	104	102	99	92	84	79	103
54.0	II	107	113	108	112	97	93	86	82	110
60.0	I	106	109	108	106	94	89	82	78	105
66.0	I	107	108	108	103	92	86	81	77	104

Relative Cost and Budget Price (US \$) includes Fan, ODP motor and drives and does not include accessories. (3/4 hp and above)
 Operating cost (US \$) based on 12 hours/day, 250 days/year and \$.05 per kw/h. Right click on grid to change operating criteria
 AMCA Licensed for Sound and Air Performance. Power rating (BHP/kW) excludes drives.

Figure 53. Case Study A - Selection Software - Plenum Choices at Lower Design Pressure

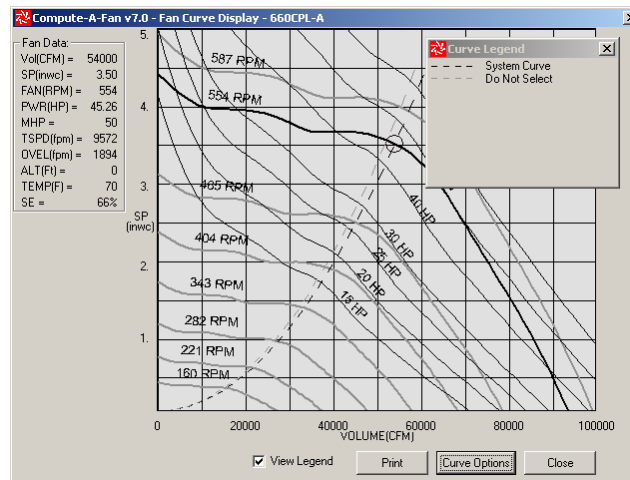

Figure 54. Case Study A - 66" Plenum Fan Design Point

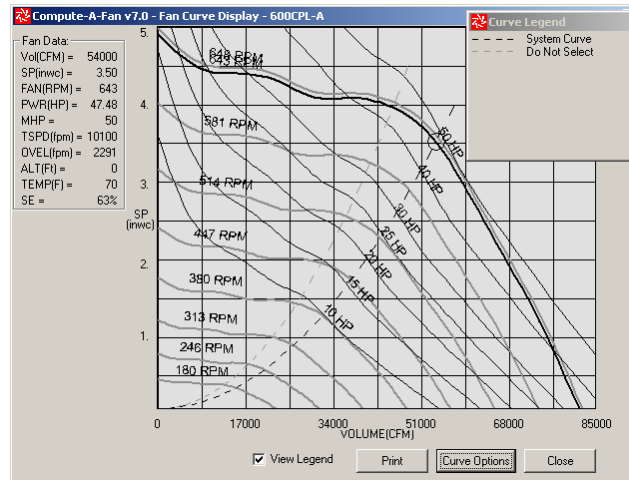

Figure 55. Case Study A - 60" Plenum Fan Design Point

Part Load Performance

We selected one or two fans of each fan type for further analysis. Using a handful of manufacturer's data points, we developed Characteristic Fan Curve models for each fan. Part load performance depends on the shape of the true system curve. If static pressure setpoint reset is perfectly implemented, the true system curve runs from the design point through 0" at 0 CFM and the fans are all constant efficiency since this is a characteristic system curve. If however, static pressure setpoint reset cannot be perfectly implemented (as is typically the case in real applications), the true system curve will run through some non-zero static pressure at 0 CFM and fan efficiency will not be constant. In order to bound the problem, we evaluated the fans using both perfect static pressure setpoint reset and no static pressure setpoint reset (fixed SP of 1.5" at 0 CFM) (see Figure 56). With perfect reset, the fan efficiency is constant throughout part load operation (see Figure 56). Figure 57 shows the design efficiency of each of the fans that we simulated.

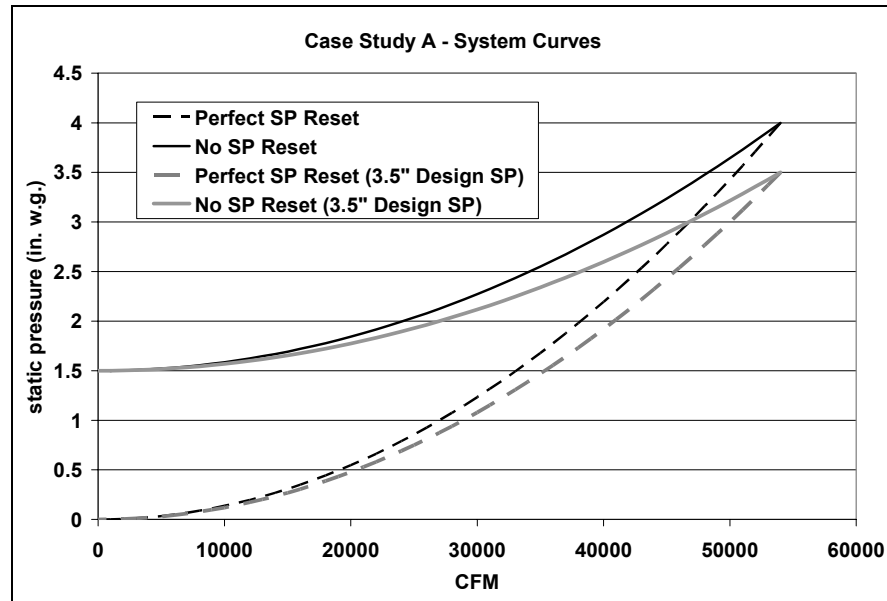

Figure 56. Case Study A - System Curves

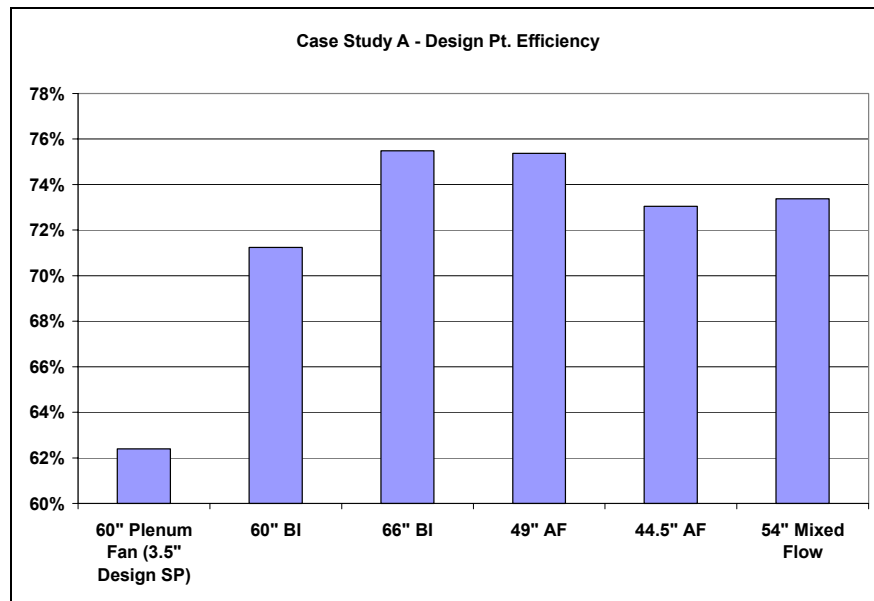

Figure 57. Case Study A - Design Point Efficiency

With no static pressure setpoint reset, the fan efficiency varies at part load. Figure 58 shows that the efficiency actually increases slightly as the fan starts to ride down the system curve and then decreases at very low load.

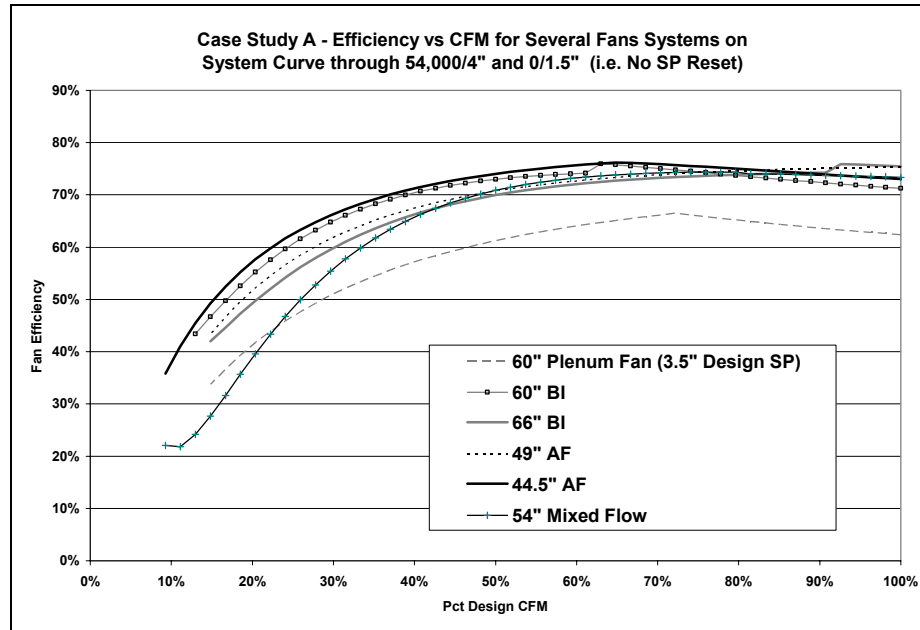

Figure 58. Case Study A - Part Load Fan Efficiency

Figure 59 is identical to Figure 58 except that it only shows the non-surge region, i.e., where the fans go into surge. The 66\" BI fan, for example, goes into surge at 85% flow on this system curve. Interestingly, the efficiency of the 61\" BI in the surge region is similar to that of the other housed fans, indicating that the issue with surge is not efficiency but control stability, vibration, and noise.

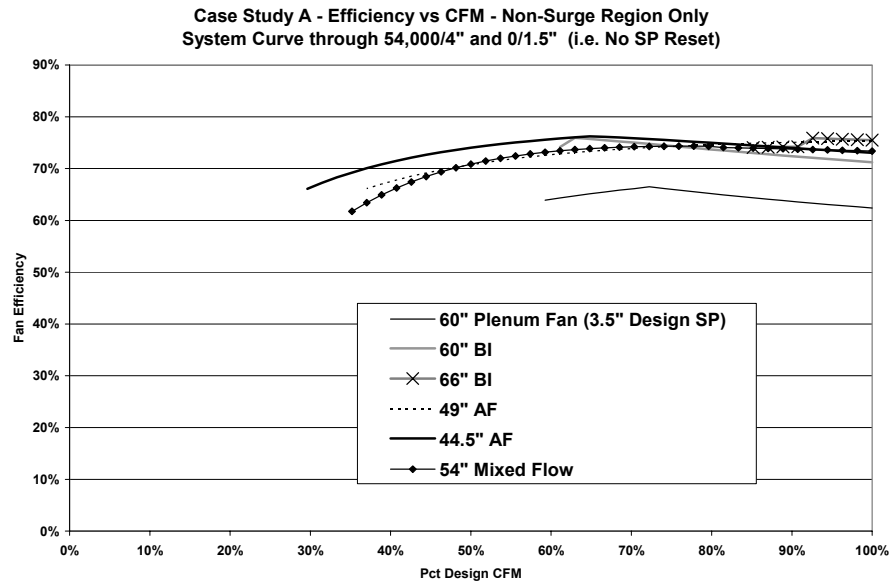

Figure 59. Case Study A - Part Load Efficiency (Non-surge Region Only)

Figure 60 shows the fan power of the Case Study A fan systems as a function of CFM. It includes the part load efficiency of the fan, belts, motor, and variable speed drive.

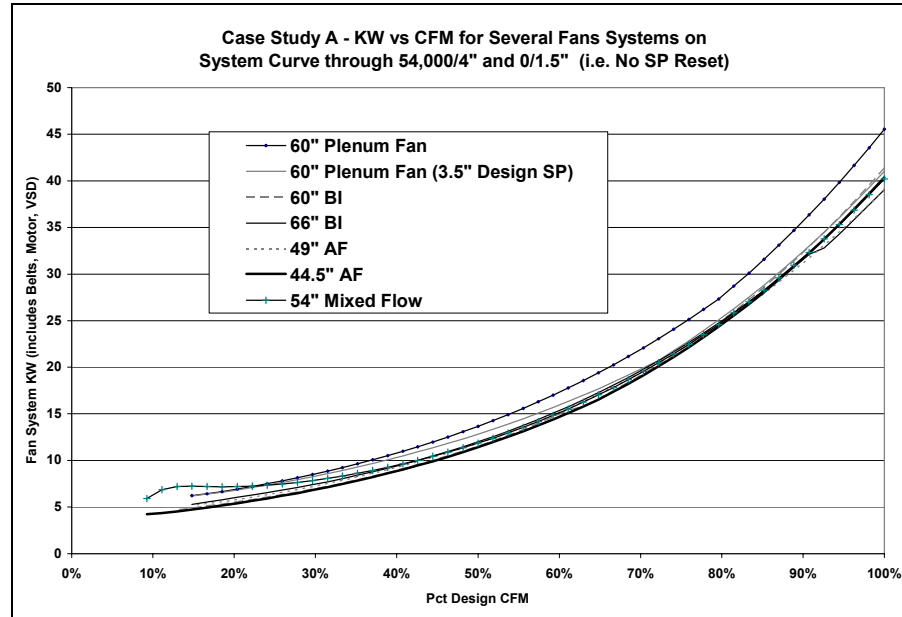

Figure 60. Case Study A - kW versus CFM

Figure 61 reflects another way to represent the part load efficiency of some fans evaluated in Case Study A. It shows the design point for the case study and how the fan efficiency changes when moving away from the system curve of the design point.

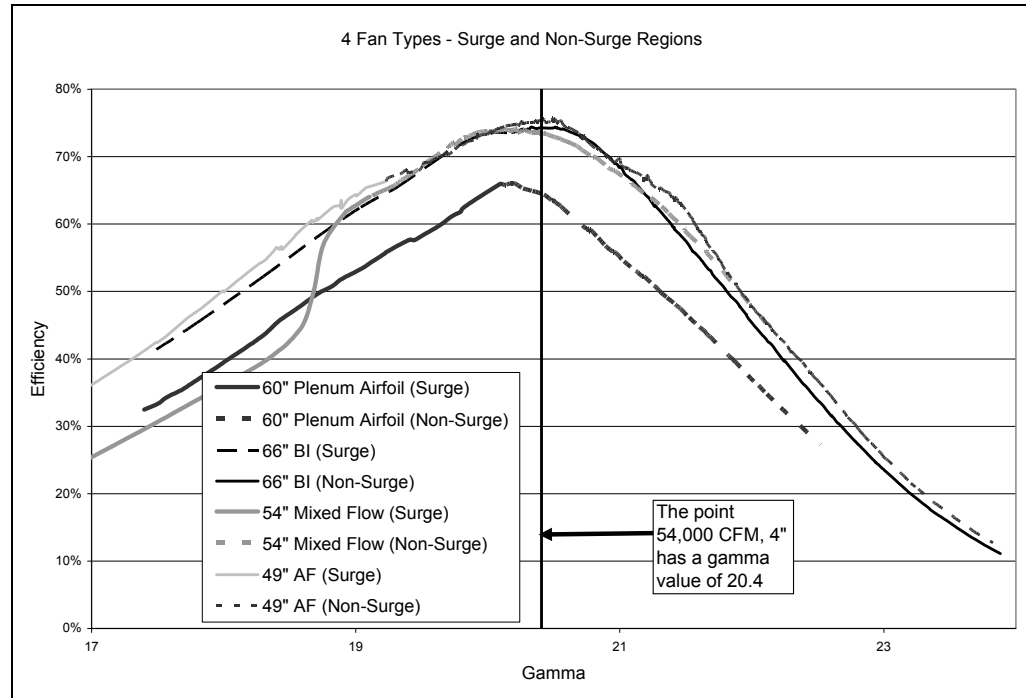

Figure 61. Case Study A - Gamma Curves

Extrapolating from Part Load Performance to Annual Energy Cost

There are several ways to estimate annual energy cost for a fan system. One method involves developing a hypothetical fan load profile using DOE-2 and then applying the part load kW to each point in the load profile. Figure 62 shows histograms of three load profiles developed using DOE-2 as part of the VAV box sizing simulation analysis (See “Appendix 6 – Simulation Model Description”). These profiles represent an office building in the California Climate zone 3 (a mild coastal environment that includes San Francisco). The High Load Profile assumes that most of the lights and equipment are left on during occupied hours. The 24/7 profile represents continuous fan operation.

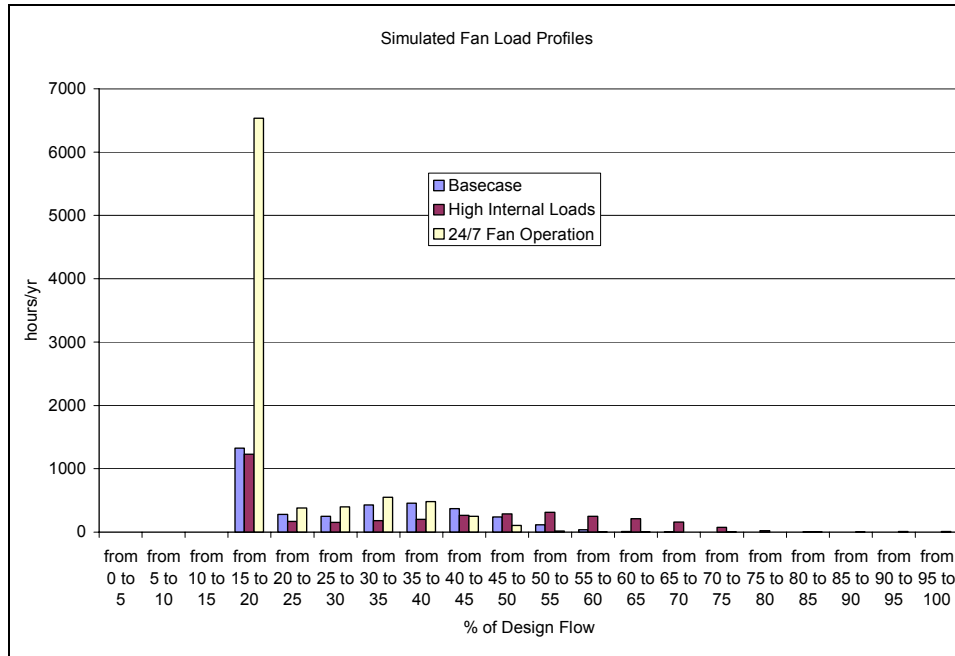

Figure 62. Case Study A - Load Profiles

Figure 63 shows the annual energy cost with perfect static pressure setpoint reset for each fans and load profiles evaluated. Notice that the plenum fan at 3.5” uses about as much energy as the housed fans at 4”.

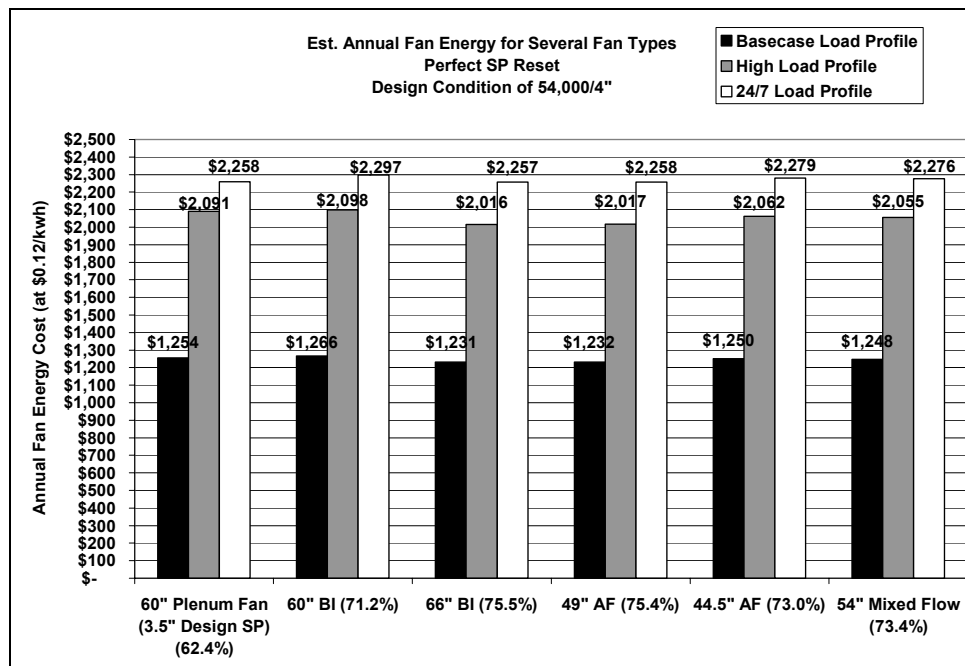

Figure 63. Case Study A Results - Perfect Static Pressure Reset

Figure 64 shows the annual energy cost with no static pressure setpoint reset for each of the fans and load profiles evaluated. Notice that the plenum fan has consistently higher energy costs than the housed airfoil and BI fans. Also energy costs in Figure 64 are more than double the costs in Figure 63, which clearly implies that *the type of fan selected is not nearly as important as how it is controlled*.

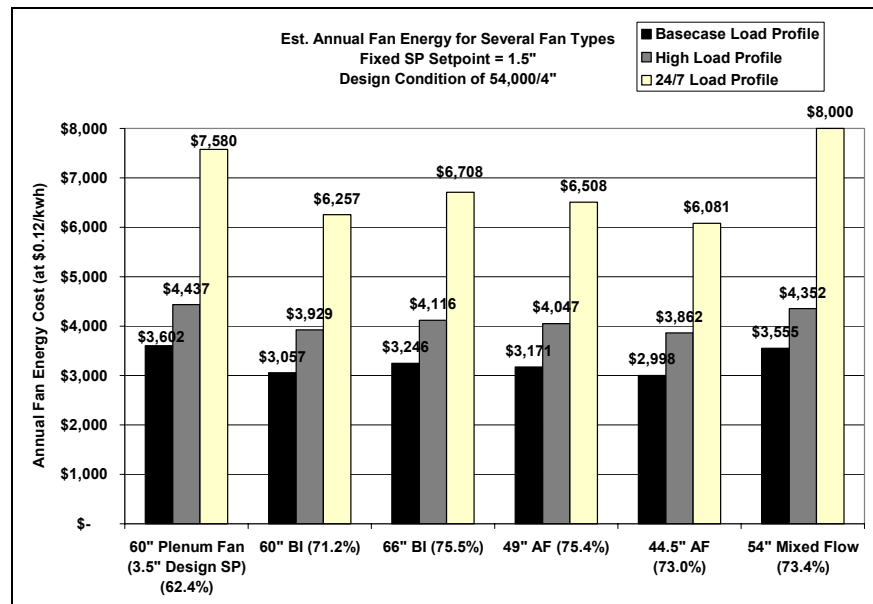

Figure 64. Case Study A Results – No Static Pressure Reset

Noise

Figure 65 summarizes acoustic data shown in Figure 51 and Figure 52 for some of the evaluated fans. Because low frequency noise is much harder to attenuate than high frequency noise, the critical octave bands are OB1 (63 Hz) and OB2 (125 Hz). While the plenum fan appears to be considerably noisier than the other types, this figure does not present a fair comparison since it does not include the effect of the discharge plenum. Figure 66, from the Carrier Air Handler Builder Program, shows air handler discharge acoustic data for a housed airfoil and a plenum fan, and includes the attenuation of the discharge plenum. The plenum fan has considerably better acoustic performance than the housed airfoil fan at the low frequency octave bands.

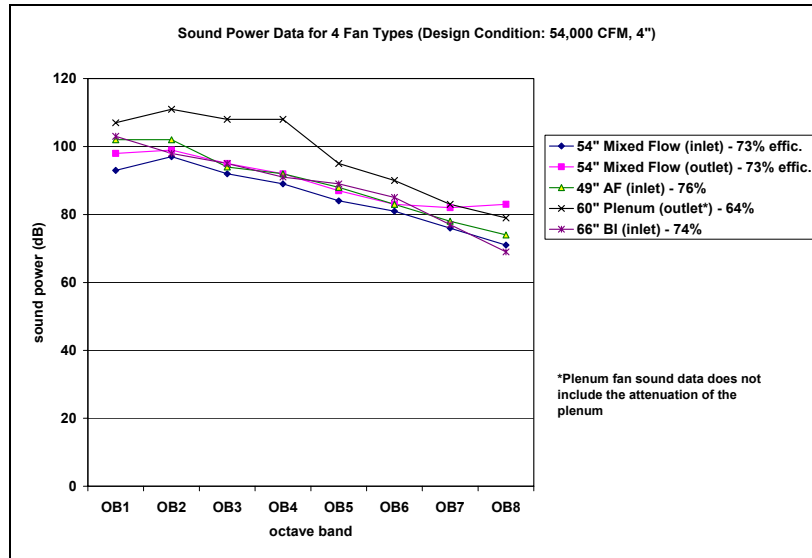

Figure 65. Case Study A - Acoustic Data (No Casing)

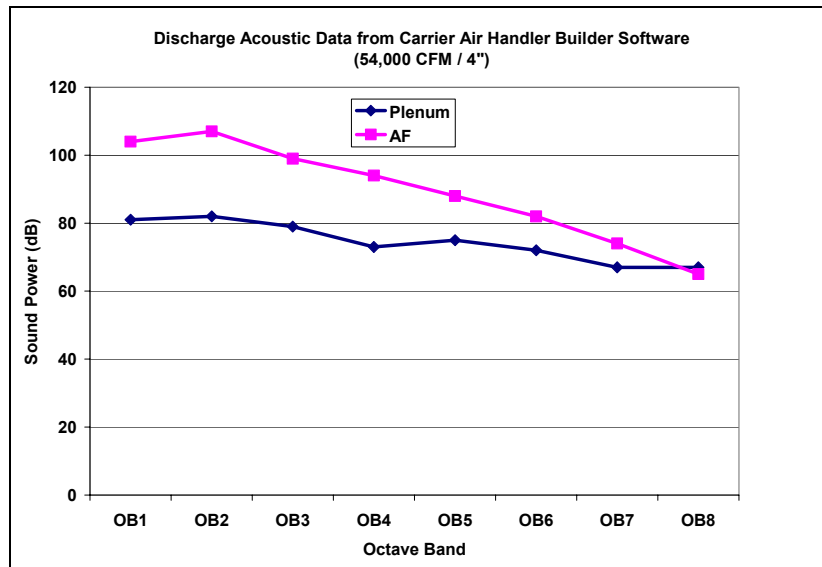

Figure 66. Case Study A – Carrier Acoustic Data (With Casing)

Curiously, the McQuay air handler selection software showed plenums fans having little or no sound advantage over housed airfoil (AF) and forward-curved (FC) fans (Table 21). The differences could have to do with the way the discharge sound power is measured. For example, the outlet for the Carrier discharge plenum is field cut so clearly the manufacturer is making some assumption about the size and location of that outlet when rating the sound power.

Another suspicious aspect of this table is the very high efficiency of the Carrier plenum fans. In fact, the Carrier catalog shows these fans having lower efficiency

that is more in line with the other air handler and fan manufacturers' data. All this information simply reinforces Rule #1 of HVAC design: "Do not always believe manufacturers' data."

Table 21. Manufacturers Air Handler Selection Software Fan Data

																Discharge Sound Power
Manuf.	Unit	CFM	TP	FanType	Dia.	BHP	RPM	SE	OB1	OB2	OB3	OB4	OB5	OB6	OB7	OB8
Carrier	92	54,000	4	Plenum		44.4	630	77%	81	82	79	73	75	72	67	67
Carrier	92	54,000	4	AF		57.1	1074	60%	104	107	99	94	88	82	74	65
Carrier	92	50,000	4	Plenum		41.1	615	77%	81	82	78	73	74	72	67	66
Carrier	92	50,000	4	AF		50.3	1028	63%	103	106	98	94	87	82	73	65
Carrier	92	45,000	4	Plenum		37.8	598	75%	80	81	77	72	74	71	66	65
Carrier	92	45,000	4	AF		42.5	971	67%	102	105	97	92	86	80	72	63
Carrier	92	40,000	4	Plenum		34.6	585	73%	80	81	76	72	73	70	65	65
Carrier	92	40,000	4	AF		35.9	918	70%	101	104	96	91	85	79	71	62
Carrier	61	30,000	4	Plenum		24.6	944	77%	75	79	77	72	73	73	69	67
Carrier	61	30,000	4	AF		26.7	951	71%	99	102	95	90	84	78	69	61
Carrier	61	30,000	4	FC		29.4	539	64%	99	99	97	91	84	78	69	59
Carrier	39	20,000	4	Plenum		16.7	1196	75%	69	78	77	70	71	72	70	67
Carrier	39	20,000	4	AF		18.5	1389	68%	98	98	97	89	83	77	69	60
Carrier	39	20,000	4	FC		20.5	722	61%	98	98	93	94	84	78	70	61
McQuay	50	20,000	4	Plenum	40.25	18.5	954	68%	88	96	93	91	87	85	79	74
McQuay	50	20,000	4	AF	33	16.4	1021	77%	91	96	91	89	86	80	76	68
McQuay	50	20,000	4	FC	27.62	19.8	705	64%	90	88	85	85	79	78	74	68
McQuay	65	30,000	4	Plenum	49	27.7	787	68%	95	98	91	89	85	81	75	70
McQuay	65	30,000	4	AF	36.5	25.7	980	73%	93	98	93	91	88	82	78	70
McQuay	65	30,000	4	FC	33	29.6	590	64%	89	86	83	83	78	77	72	65
McQuay	90	40,000	4	Plenum	54.25	37.0	730	68%	96	99	92	90	86	82	76	71
McQuay	90	40,000	4	AF	40.25	37.8	923	67%	95	100	95	93	90	84	80	72
McQuay	90	40,000	4	FC	40.25	41.5	513	61%	98	97	95	93	91	86	81	84
Trane	66	30,000	4	FC	33	30.8	595	61%	100	97	97	95	90	86	80	74
Trane	66	30,000	4	AF	36.5	26.7	970	71%	96	100	96	91	86	79	72	68
Trane	66	30,000	4	Q	44.5	29.6	1191	64%	94	96	96	97	95	91	85	77

First Cost

Figure 67 shows the budget prices from the Cook software, which only includes the fan itself, not the cost of discharge or inlet plenums. This figure shows the housed airfoil fans to be \$100 to \$1,000 more than the plenum fan, but the discharge plenum required for the plenum fan is likely to cost considerably more than \$1,000. This figure also does not include motor and variable speed drive costs. In this case study, the plenum fan requires a 60 HP motor, while the other fan types only require 50 HP motors. The motor and VSD be more expensive for the plenum fan, along with the associated electrical service.

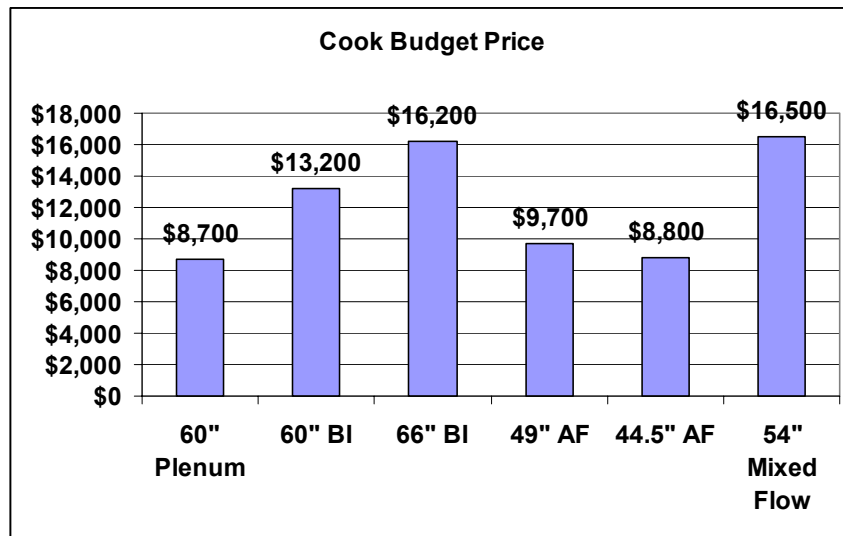

Figure 67. Case Study A - Cook Budget Prices

Case Study B

This case study is based on an actual installation: Site #1, an office building in San Jose, California. The air handler consists of two 66" plenum fans in parallel with a design condition for each of 72,500 CFM at 4" for a total air handler design condition of 145,000 CFM at 4". In this case study we have the benefit of hindsight, in the form of about one years worth of air handler load profile data (CFM, SP). This data allowed us to evaluate the actual selection and compare it to other plenum fan sizes and to several sizes of housed airfoil fans.

We believe the project engineer selected plenum fans based on space constraints and acoustical concerns in the building, and the fact that redundancy was necessary. Looking at Figure 68, it is clear that the 73" fan has the highest efficiency, lowest noise, and highest cost. However, based on the fan curve for this size, this point is probably too close to the surge line (see Figure 69). The 66" fan that was selected by the project engineer has lower efficiency and higher noise, but the design point is farther away from the surge line (see Figure 70). Another advantage of the 66" size is that it requires a smaller motor size than the smaller fan sizes. Be aware, however, that the fan brake horsepower does not include the belts, which are likely to be about 97% efficient at this size. A fan BHP of 74.3 would have a load on

the motor of about 76.5 BHP. Of course, most motors and variable speed drives have a “service factor” allowing them to operate at least 10% above their nominal capacity. The 66” plenum fan’s good combination of efficiency, relative cost, acoustics, and motor size were undoubtedly the reasons why the engineer for this project selected this fan.

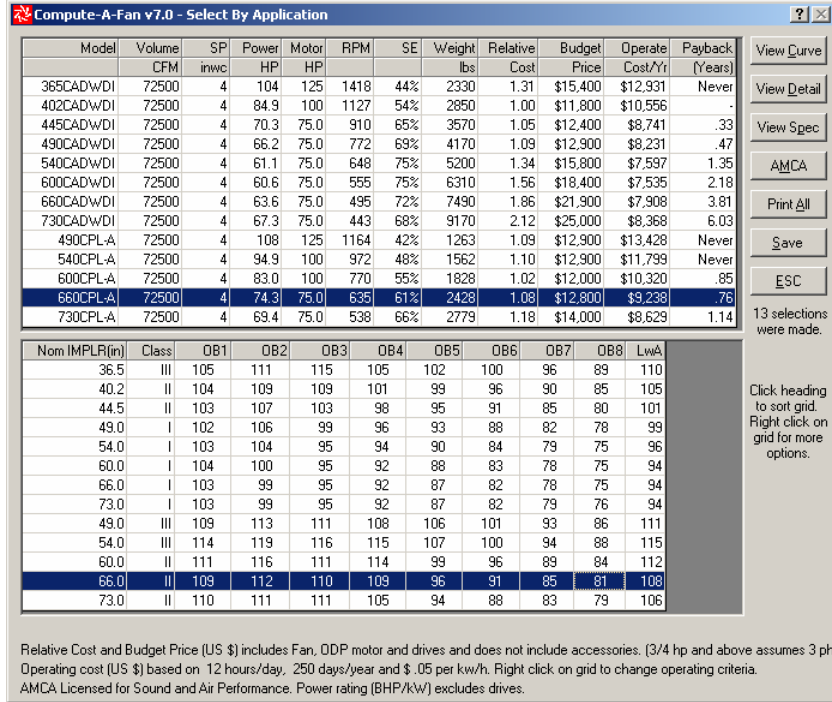

Figure 68. Case Study B - Selection Software Airfoil and Plenum Fans

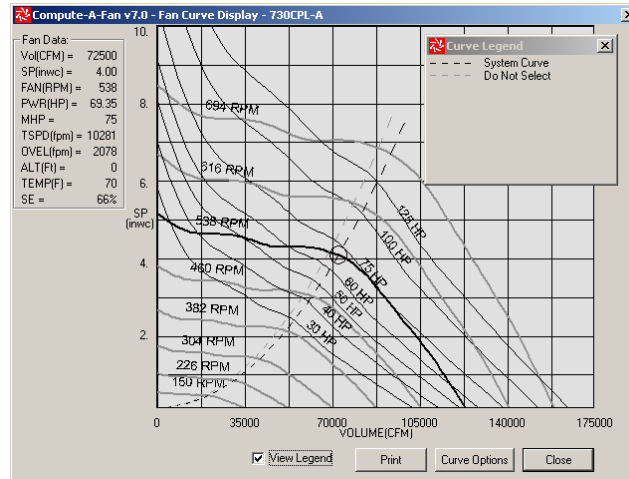

Figure 69. Case Study B - 73" Plenum Fan Curve

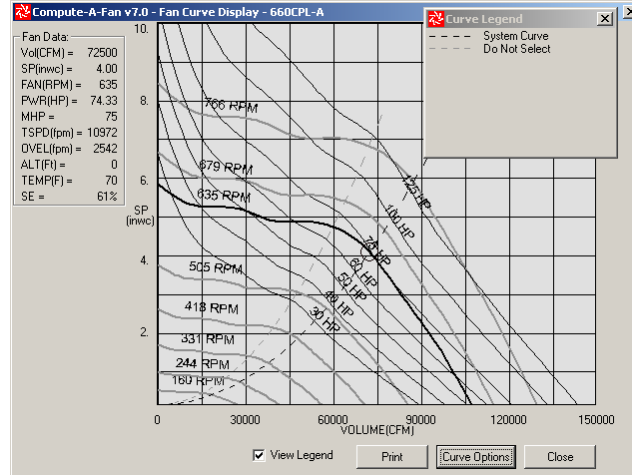

Figure 70. Case Study B – 66” Plenum Fan Curve

We evaluated this fan selection by simulating a range of potential selections against the monitored fan load profile (total CFM and differential pressure across the fan). Figure 71 indicates the monitored data and the design point that the project engineer selected. Figure 72 shows that the system spends the majority of the time at very low flows and never comes close to the design condition during the monitoring period. Figure 72 has the same X-axis scale as Figure 71, and together they display the frequency of operation for each region. As Figure 71 shows, the actual system curve appears to run through 1.5” at 0 CFM. A consequence of a high fixed static pressure setpoint is that the fan operates in the surge region at low loads. Based on the monitored data, we calculated that the fan(s) operate in the surge region over 60% of the time. Using a smaller fan would have reduced the time in surge. But a better way to reduce or eliminate this problem is to aggressively reset the static pressure setpoint.

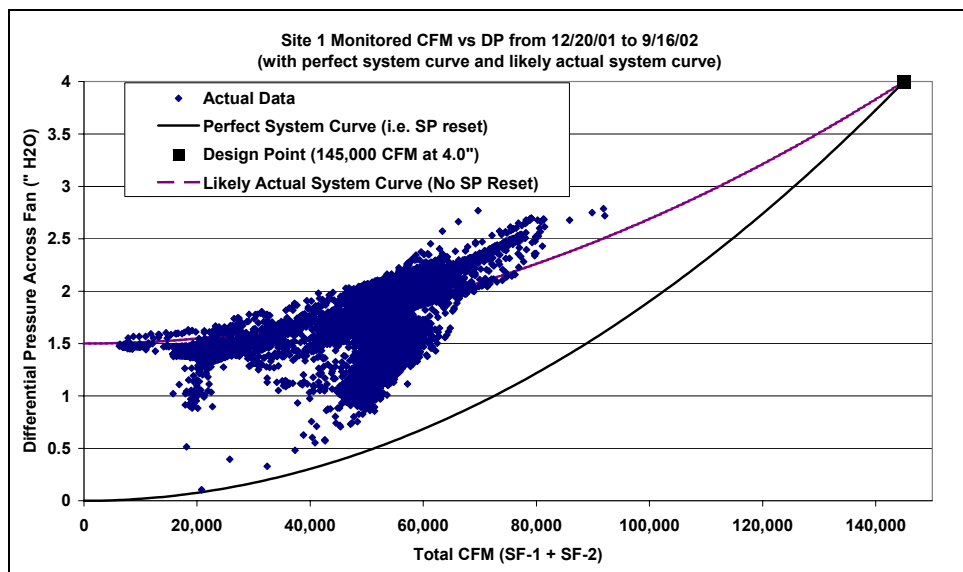

Figure 71. Case Study B - Monitored Data

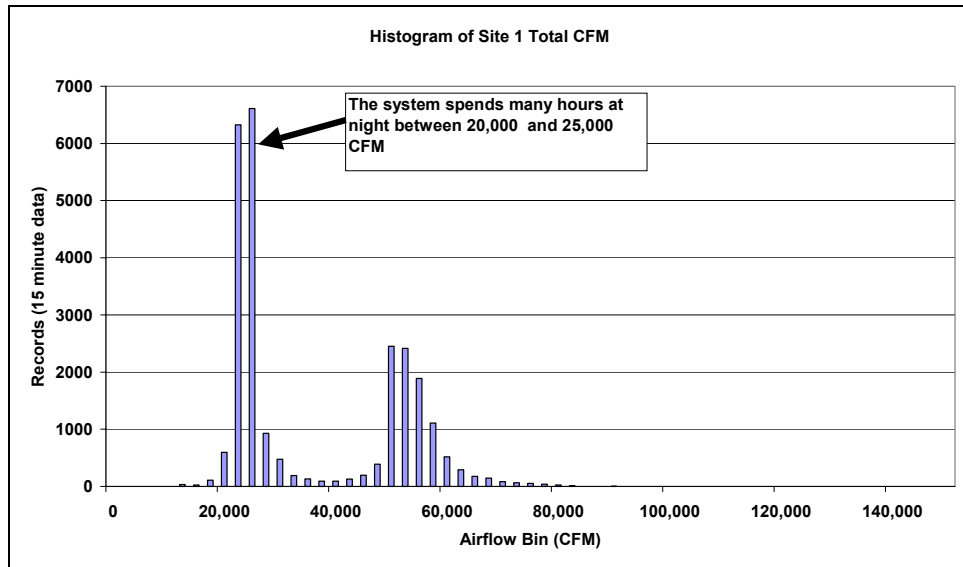

Figure 72. Case Study B - Histogram of CFM

Figure 73 shows the efficiency of the Site 1 fan system (66" plenum fan) along the apparent system curve that appears in Figure 71 as a dashed purple line. It also includes the next smaller plenum fan size (60"). Figure 73 shows that the fan efficiency goes up and down as CFM changes and as the system stages from single to dual fan operation. According to our simulations, the average fan efficiency of the actual system during the monitoring period was 57%.

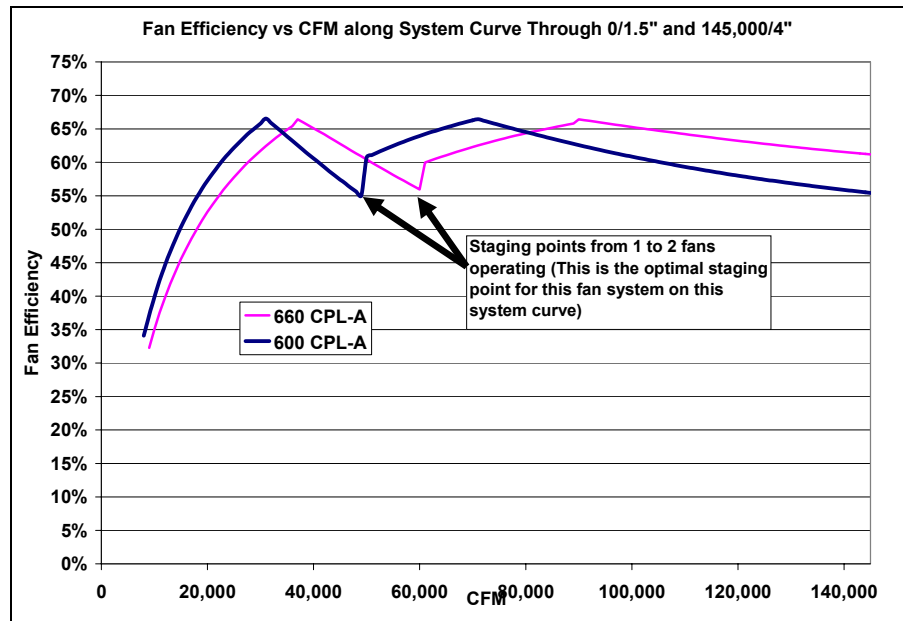

Figure 73. Case Study B – Part Load Fan Efficiency

Several other fan selections were simulated against the actual measured load, including other sizes of plenum-airfoil fans and several sizes of housed-airfoil fans. Figure 74 shows simulation results for the base case and alternate fan selections. (Based on the monitored data, the existing control sequence seems to be to run one fan almost all the time except for a few hours

per week, which turns out to be close to the optimal staging sequence because the loads are so low relative to available fan capacity.)

It is interesting to note that the annual energy ranking from the simulation (Figure 74) does not follow the efficiency ranking from the manufacturer’s selection program (Figure 68). Several reasons exist for this discrepancy. One reason has to do with the valleys and peaks (or “sweet spots”) in the efficiency profile of each fan (see for example Figure 73) compared to the load profile. Different fan systems have peaks and valleys at different spots.

Figure 74 also reveals that housed-airfoil fans (the fans marked CADWDDI) are consistently more efficient than the plenum fans (the fans marked CPL-A). Of course, this is not necessarily a fair comparison because of the space requirements and acoustic issues with housed fans as previously noted.

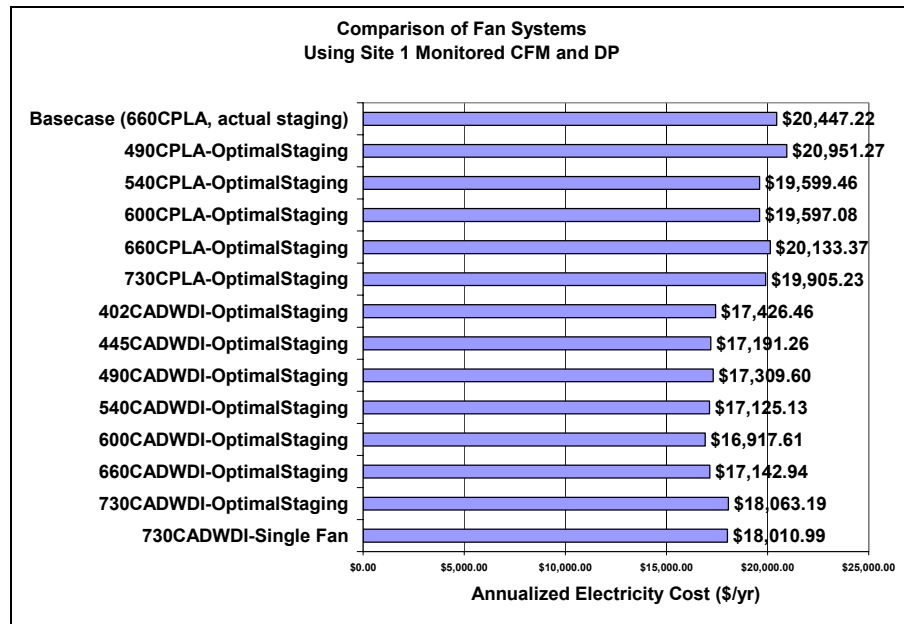

Figure 74. Case Study B Simulation Results - No Static Pressure Reset

The impact of static pressure setpoint reset on both the annual energy use and the fan selection was also evaluated. To simulate reset, a new load profile was developed by replacing the monitored pressure with the pressure from the system curve in Figure 71 (perfect reset line) for the same airflow as the monitored data. These reset data were used to compare the performance of the same fans evaluated in Figure 74. The results are presented in Figure 75. It shows that annual fan energy use can potentially be cut by as much as 50% if static pressure setpoint reset is successfully implemented (Compare Figure 74 and Figure 75). This corroborates the results reported by Hartman (Hartman 1993) and others, as well as the results of Case Study A.

Figure 75 also shows that annual energy ranking now follows the efficiency ranking shown in Figure 68, because a fan operating on a perfect system reset curve has constant efficiency. This is also one of the reasons that static pressure setpoint reset saves so much energy – not only is the fan doing less work (maintaining lower static pressures), but it is doing it at higher efficiency and staying out of surge longer. A perfect system curve with reset starting at a point to the right of surge will never end up in the surge region.

The results in Figure 75 imply that bigger fans are better (in terms of energy cost) for systems with supply pressure setpoint reset. Indeed the estimated \$385 in annual energy savings from selecting the 73” plenum fan rather than the 66” plenum fan pays for the \$1,200 incremental cost increase (see Figure 68) with a simple payback of about 3 years. However these results need to be tempered with special considerations. In addition to the first cost of the fan, other first costs should be considered, including the impacts on space and the electrical service. These results should also be weighed against the increased risk that the fan will operate in surge should perfect reset not occur. (The most common cause of less-than-perfect reset is a zone or zones that are undersized, have lower than design temperature setpoints, or have consistently high loads, all of which can result in steady high demand for static pressure, even when the rest of the system is at low load.) The bigger the fan, the closer the design point is to the surge region and the greater the risk of operating in surge for a less than perfect reset curve.

Figure 75 also shows that a single 73” airfoil fan can serve the load more efficiently than almost any other option evaluated. A single housed airfoil fan is also likely to be less expensive than any of the parallel fan options (no backdraft damper either) but of course, redundancy is lost.

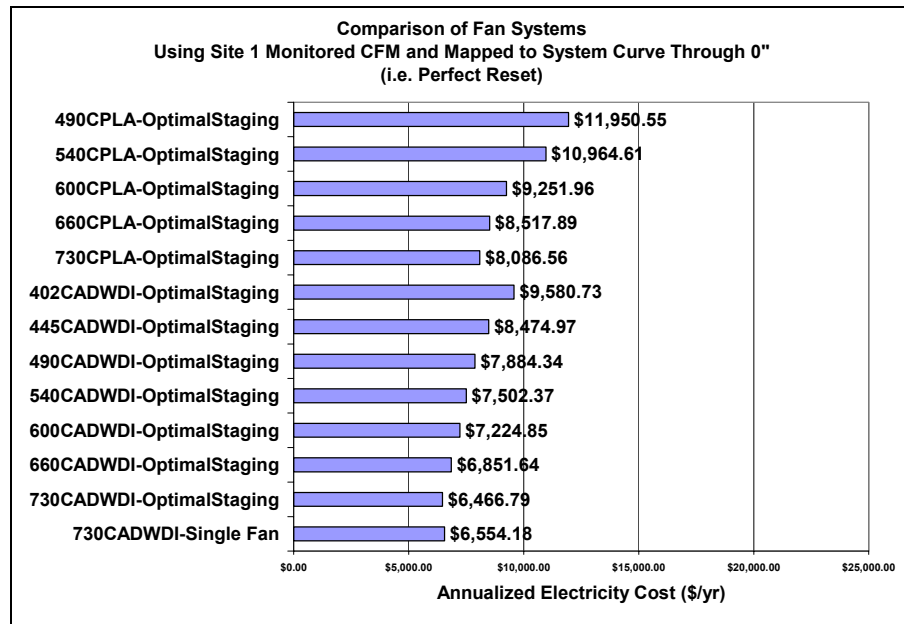

Figure 75. Case Study B Simulation Results - Perfect Static Pressure Reset

Space Constraints

As mentioned earlier, Figure 74 and Figure 75 are not really “apples-to-apples” comparisons because the housed airfoil fans are likely to have higher total pressure drop due to discharge system effects. In order to answer the question “How much extra pressure drop would make the housed fan no longer worth using?”, we simulated the housed airfoil fans with an additional pressure drop at each fan discharge. We compared the 66” plenum and the 54” housed airfoil, assuming no static pressure setpoint reset. The breakpoint was 1.25” extra inches of pressure drop. In other words, an airfoil fan with a design condition of 72,500 and 5.25” is just as efficient on a life-cycle cost basis as a plenum fan with a design condition of 72,500 and 4”.

Noise

Clearly noise was a major concern when the engineer selected the fans for Site 1. Not only were plenum fans chosen, but sound traps were also employed. Figure 76 shows that sound traps were inserted into the discharge plenum at each riser take-off.

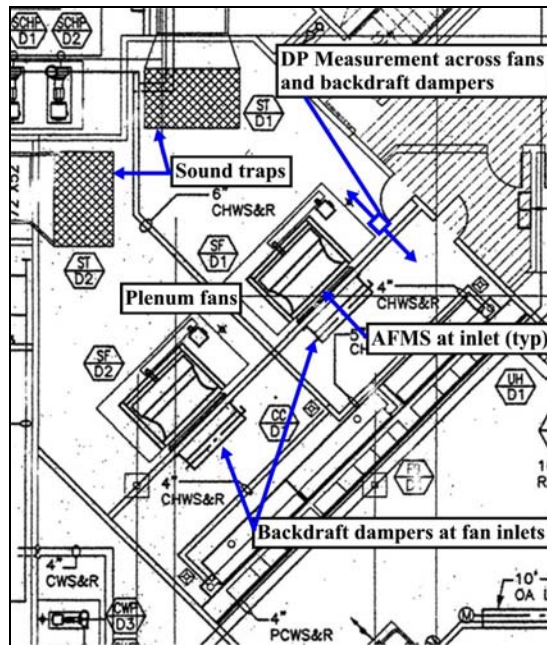

Figure 76. Plan View of Site 1 Air Handler

Another acoustical advantage that plenum fans have over housed fans is that they are much more amenable to sound traps. A sound trap can be placed relatively close to a plenum fan because the velocity is fairly low and uniform in the discharge plenum. A sound trap cannot be placed too close to a housed fan because of the uneven velocity profile at the fan discharge. A sound trap in a large office building in San Francisco was placed too close to the fan (shown schematically in Figure 77). In that building, the sound trap was selected for 0.25" pressure drop at the design airflow rate, but the actual pressure drop was measured at 1.2". In extreme cases such as this, a sound trap can actually increase the sound level because the fan has to speed up to overcome the extra pressure drop.

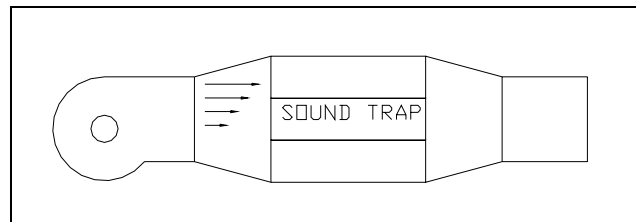

Figure 77. Velocity Profile Off of Housed Fan

Comparing Manufacturers

We have compared fan performance from several manufacturers for a variety of fan types and none of them stand out as consistently more-or-less efficient from one manufacturer to another. Clearly there are some differences, but we suspect that the significant similarities are due in large part to how the fans are tested and rated, not necessarily from true differences in efficiency. And as mentioned in an earlier section, some obvious inaccuracy exists with the manufacturers rating tests. Figure 78, for example, shows that the Temtrol 27" plenum fan is less efficient than the 24" and the 30" models. We suspect that this may have more to do with the accuracy of the testing than with the true efficiency of the fans.

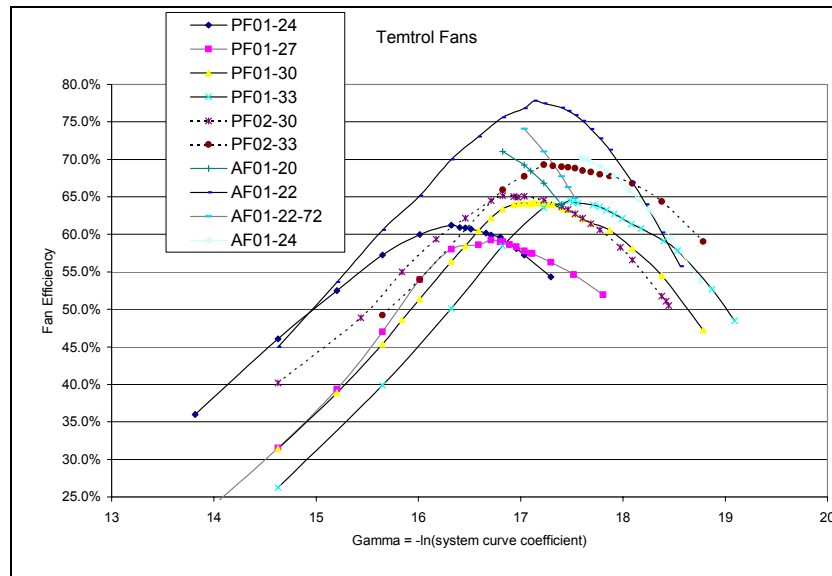

Figure 78. Temtrol Plenum Fan Data

This issue is further complicated by the fact that large parts of the manufacturers' reported fan data are extrapolated from actual factory test data. Data is calculated using the assumption of fixed efficiency along a fan characteristic system curve. Data is also extrapolated between fan sizes within a model line using other perfect fan laws. Under ANSI/ASHRAE Standard 51-1999 (ANSI/AMCA Standard 210-99), manufacturers are not required to test all fan sizes. According to the standard, test information on a single fan may be used to determine the performance of larger fans that are geometrically similar using the so-called "fan laws," which have many simplifying assumptions.

Figure 50 clearly reveals, for example, that Cook only tested three of their 17 mixed flow fan sizes and then extrapolated that data to the other sizes.

Figure 79 shows the highest efficiency for all Cook and Greenheck housed airfoil fans as a function of wheel diameter. By reviewing the step changes in the peak efficiency data as a function of fan diameter, it is clear from this figure which fans the manufacturers tested and which they extrapolated (see also Figure 47 and Figure 48). Both manufacturers tested their 30" fans. Cook then extrapolated the 30" data all the way up to 73". (The variability in the peak efficiency of the Cook 30" to 73" fans is due to rounding and sampling error.) Greenheck only extrapolated the 30" up to 36", then they

tested the 40" and extrapolated that all the way to 73". Cook's 30" is more efficient than the Greenheck 30" but not more efficient than the Greenheck 40". Had Cook tested a 40" (or larger) fan, they might have found that it had higher efficiency than equally sized Greenheck fans.

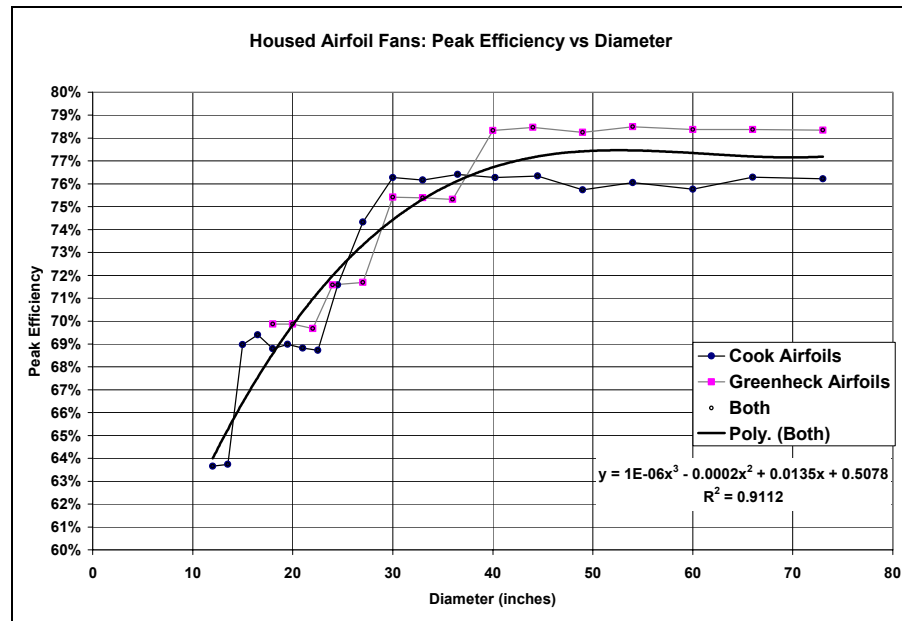

Figure 79. Peak Efficiency of Cook vs Greenheck Housed Airfoil Fans

Fan Control

Fan Speed Control

By far the most common and most efficient way of controlling medium to large VAV fans is with variable speed drives (FSDs). Riding the fan curve, discharge dampers, inlet vanes, and variable pitch blades were all common in the past but are rarely a good option given the relatively low cost and energy savings from VSDs. The current version of Title 24 requires fans of 25 HP and larger to have either variable speed drives (or variable pitch blades for vane-axial fans), and the proposed 2005 version is dropping this minimum to 10 HP.

The location of the static pressure sensor can greatly affect the energy efficiency potential of a system when a fixed static pressure setpoint is used. An old rule of thumb was to locate the sensor "2/3rd of the way down the duct," but this approach wastes energy and is not recommended. Instead, the sensor should be as far out in the system as possible, with multiple sensors used if there are branches in the duct main. The design condition SP setpoint should be the minimum SP necessary to get the air from the sensor location through the ductwork to the hydraulically most remote VAV box, through its discharge ductwork and air outlets, and into the space. The further the sensor is located from the fan, the lower the SP setpoint needs to be, and vice versa. The worst case is to locate the sensor at the fan outlet. The setpoint would have to be high enough to deliver supply air to the most remote space at the maximum airflow that will occur at design conditions. This setpoint would cause the fan to operate against a constant discharge pressure and

nearly constant total pressure. The energy usage of the fan would then be linear with airflow while the fan would use close to the cube of the airflow ratio if the sensor were located near the extreme end of the system.

If the static pressure setpoint is reset (see Demand-Based Static Pressure Reset), the location of the sensor theoretically makes no difference since its setpoint will always be only as high as needed for the box requiring the highest pressure. However, it is recommended that it be located as far out into the system as practical to ensure proper operation if the reset logic fails (any setpoint reset logic must be well tuned to provide stable performance.)

Practical considerations include: limiting the number of sensors to as few as possible, usually one; and locating the sensor upstream of fire/smoke dampers (FSD) or isolation zone damper. For example, in a high-rise building with a central air handler on the roof that uses FSDs for off-hour floor isolation, the SP sensor should be located at the bottom of the riser (e.g., just before the ground floor damper). If the sensor were downstream of an isolation or FSD damper, the system will not function properly when that damper is closed but other parts of the building are in operation.

Figure 80 shows the energy impact of the minimum static pressure setpoint on total fan system energy (fan, belts, motor, and VSD). At 50% flow, the fan on the 1.5" system curve uses about twice as much energy as the fan on the 0" curve. At 20% flow, the 1.5" fan uses about four times as much energy as the 0" fan.

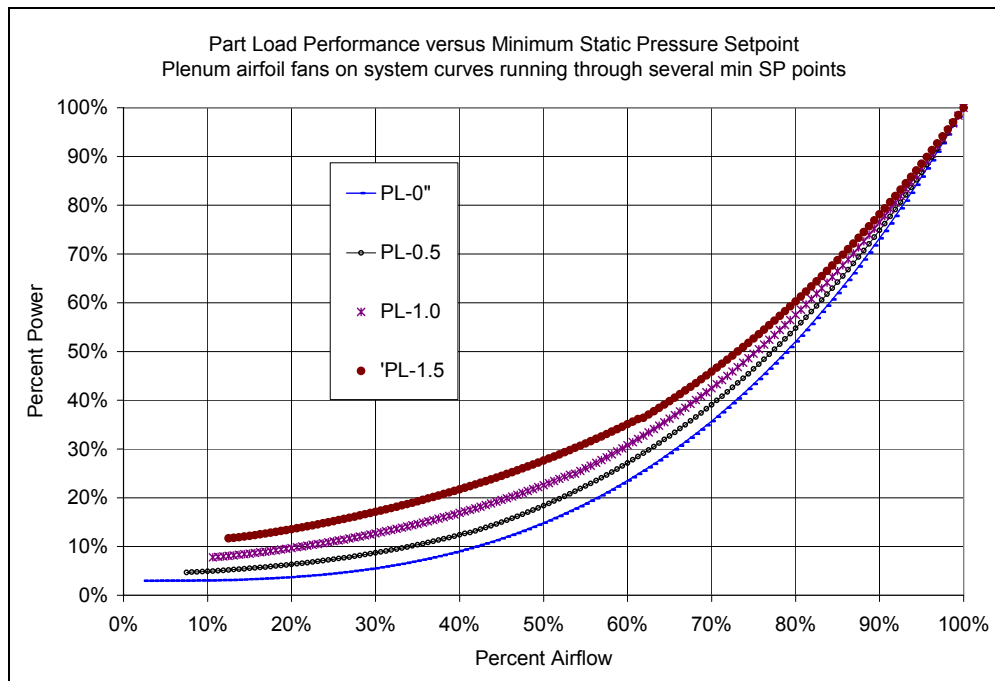

Figure 80. SP Setpoint vs Fan System Energy

As part of this research, we have developed DOE-2 fan curves for each of the curves shown in Figure 80, as well as several other curves representing other fan types and minimum SP setpoints. These curves appear in Appendix 5 – DOE-2 Fan Curves.

It is also important that the SP sensor input and the variable speed drive output speed signal be located on the same DDC control panel. This control

loop is too critical and to be subject to the variations in network traffic and other vagaries of the building-wide DDC control system.

Demand-Based Static Pressure Reset

As illustrated in the case studies above, demand based static pressure setpoint reset has tremendous potential for saving energy and reducing noise, as well as reducing or eliminating fan operation in surge.

Demand-based static pressure setpoint reset can only be effectively implemented on a system with zone-level DDC controls and some signal from the VAV box controllers back to the DDC system indicating VAV box damper position. This signal may be either the damper signal if modulating actuators are used, or estimates of damper position based on timing open/close signals if floating actuators are used. A full-open position switch on the actuator may also be used, although with more zones not satisfied. A sample control sequence for static pressure setpoint reset is as follows:

1. SP setpoint shall be determined within the range of 0.5" to MaxP by a direct-acting control loop whose control point is the damper position of the most open VAV damper and whose setpoint is 90% open. In other words, the static setpoint will be reset to maintain the VAV box requiring the most static pressure at 90% open.
2. MaxP shall be determined by the air balancer in conjunction with the control contractor as required to provide design airflow in all boxes downstream of the duct static pressure sensor. (See Determining Static Pressure Setpoint.)
3. Supply fan speed is controlled to maintain duct static pressure at setpoint when the fan is proven on. Minimum speed is 10% for motor cooling. Where the isolation areas served by the system are small, provide multiple sets of PI gains that are used in the PI loop as a function of a load indicator (e.g., supply fan airflow rate, the area of the isolation areas that are occupied, etc.).

Static pressure reset requires careful loop tuning. The reset control loop must be very slow relative to zone airflow control loops because a change in static pressure has an immediate effect on VAV airflow and hence damper position.

Static pressure reset also relies on reasonably good agreement between box sizing and actual loads. If one particular box or branch duct is significantly undersized, that box may always be wide open and the zone undercooled, in which case no static pressure setpoint reset is possible. One possible solution in this situation is to exclude that box from the logic used to determine the SP setpoint. That approach may suffice if the zone is a storage room, but if it contains the boss's office then a better solution is to replace the box. A single "rogue zone" or undersized box on a large VAV system could result in thousands of dollars of lost energy savings on an annual basis.

One way to avoid the rogue zone problem is to oversize questionable zones, especially cooling-only zones such as server rooms. In general, of course, oversizing should be avoided because it leads to excessive reheat, but a cooling-only zone with a zero minimum flow can be oversized because there is no reheat penalty. A good example is a computer server room served by a VAV box. The room does not need minimum ventilation or heating so an

oversized cooling-only box with zero minimum is appropriate. The room will operate continuously, even when most other zones are unoccupied making it particularly important for this type of zone not to require a high SP when the overall system is at low flow.

Figure 81 reflects two weeks of monitored data from a 30,000 CFM VAV air handler showing the static pressure setpoint being reset from 0.9” down to 0.15”. It also shows that the actual static pressure is closely tracking the setpoint, although it increases its hunting as the fan speed is reduced.

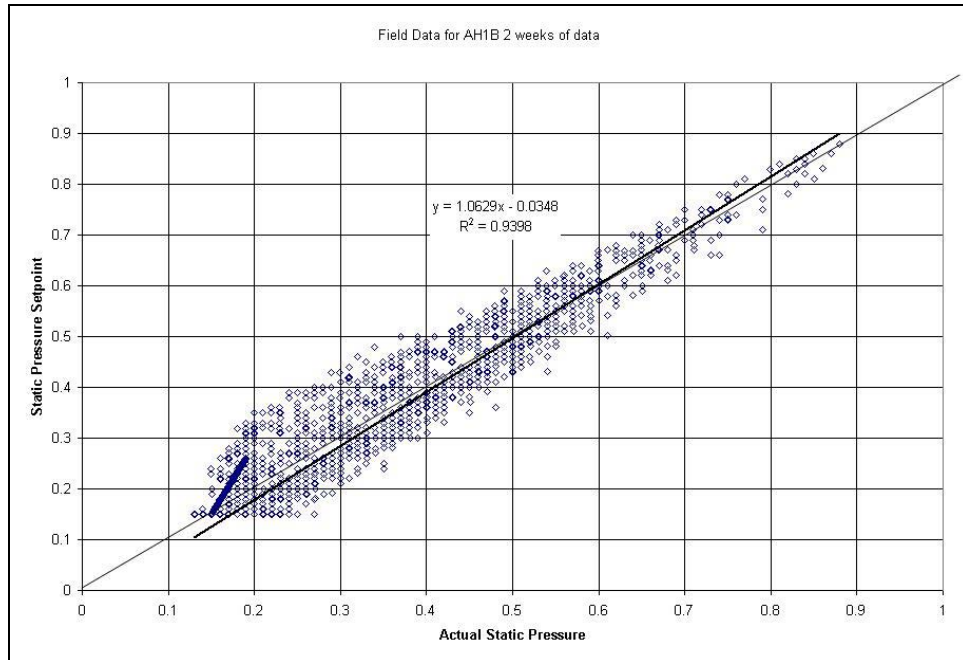

Figure 81. Monitored Data Illustrating Static Pressure Reset

Other methods of supply pressure reset include “trim and respond” controls and load demand based control (Hartman, 2003).

Determining Static Pressure Setpoint

Even if DDC is available at the zone level and reset controls are to be used, the design static pressure setpoint must be determined in the field in conjunction with the air balancer. The setpoint determined below is the fixed static pressure setpoint for systems without reset and it is MaxP when reset is used as described above.

1. Set all boxes downstream of the static pressure sensor to operate at maximum airflow setpoints.
2. Set all boxes upstream of the static pressure sensor to full shut-off (zero flow).
3. Manually lower fan speed slowly while observing VAV box airflow rates downstream of the static pressure sensor. Stop lowering speed when one or more VAV box airflow rates just drops 10% below maximum airflow rate setpoint.

4. Once flow condition in previous step is achieved, note the DDC system static pressure reading at the duct static pressure sensor. This reading becomes the static pressure setpoint:
5. If there are multiple static pressure sensors, repeat steps above for each sensor. Each should have its own static pressure setpoint and control loop with the fan speed based on the largest loop output.

Fan Staging

Multiple fans in parallel are typically staged based on fan speed signal, with some deadband to prevent short cycling. All operating fans must be controlled to the same speed. The optimal speed for staging up (e.g. from one to two fans) and staging down (e.g. from two to one fan) is a function of the actual system curve, which of course is a function of the SP setpoint and static pressure setpoint reset.

Figure 82 and Figure 83 present optimal staging speeds for two-fan system in the Case Study B with and without supply pressure reset. In these figures, the solid lines represent the power consumed by the fan systems (fan, belts, motor, VSD) as they run up and down the system curve. The light dashed lines (read on the secondary y-axis) represent the speed for these fans at each condition. The heavy dashed lines show the speed at the optimal staging point. For the 66 plenum fan system and for a system curve that runs through 1.5" (i.e., fixed static pressure setpoint), the optimal point to stage from one fan to two fans occurs when the fan exceeds approximately 79% speed. Conversely, the optimal point to stage from two to one fan is when the speed drops below about 63%.

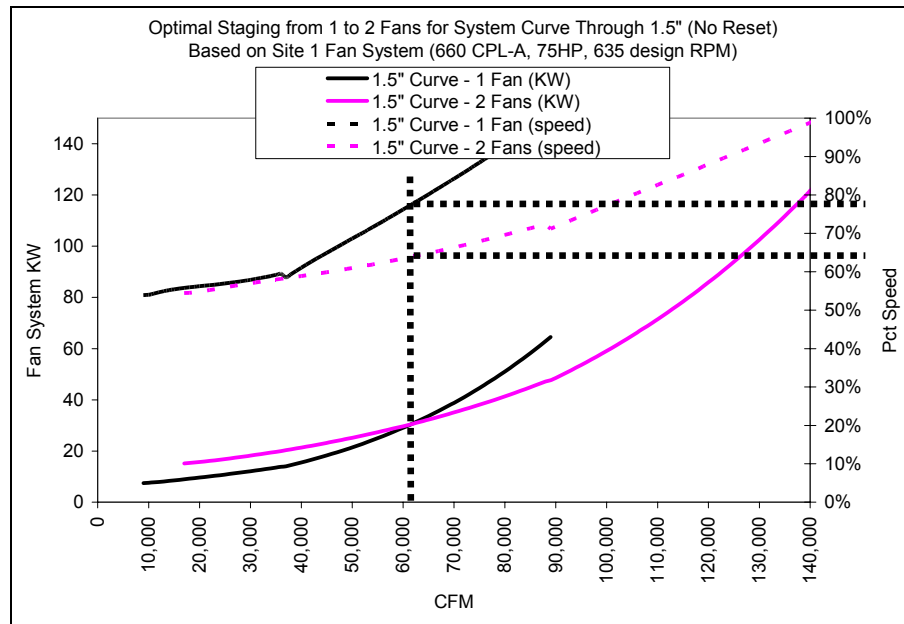

Figure 82. Optimal Staging (No Static Pressure Reset)

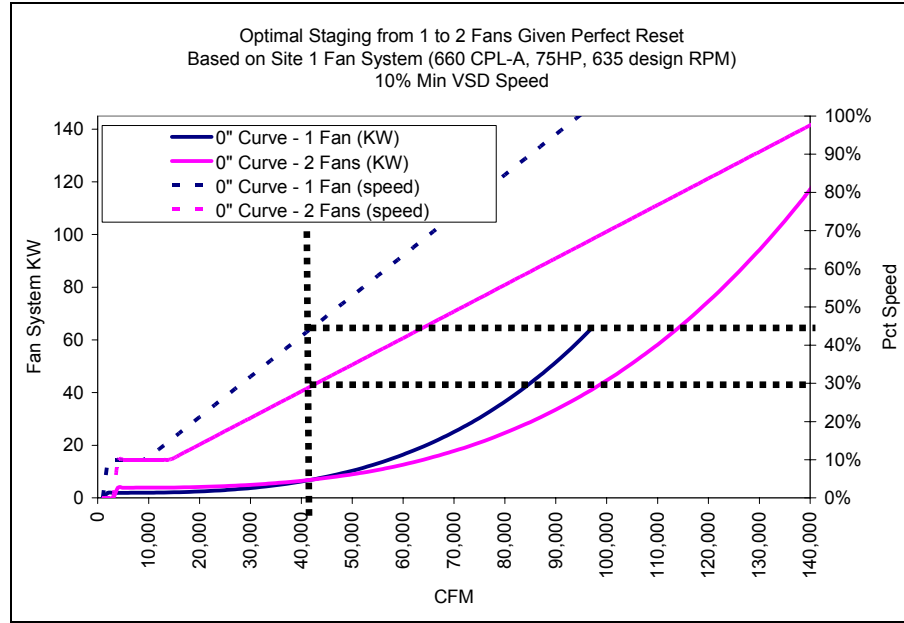

Figure 83. Optimal Staging (Perfect Static Pressure Reset)

Figure 84 shows the optimal staging points from Figure 82 (1.5”), Figure 83 (0”), as well as three intermediate points. While it may not be possible to know exactly what the minimum duct static pressure setpoint will be, a designer can use something like Figure 84 and his/her best guess of the min SP setpoint when writing the initial control sequence. That guess can then be refined in the field using data such as Figure 81 in order to fine-tune the optimal staging control sequence.

Figure 85 builds on the information in Figure 84 by including optimal staging for a 54” airfoil fan.

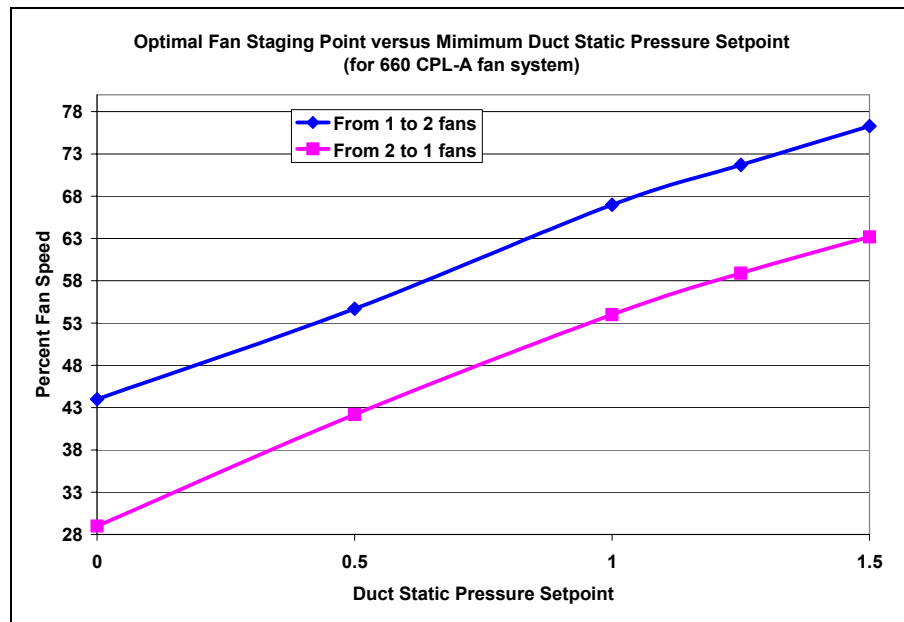

Figure 84. Optimal Staging Point vs. Minimum Duct Static Pressure Setpoint

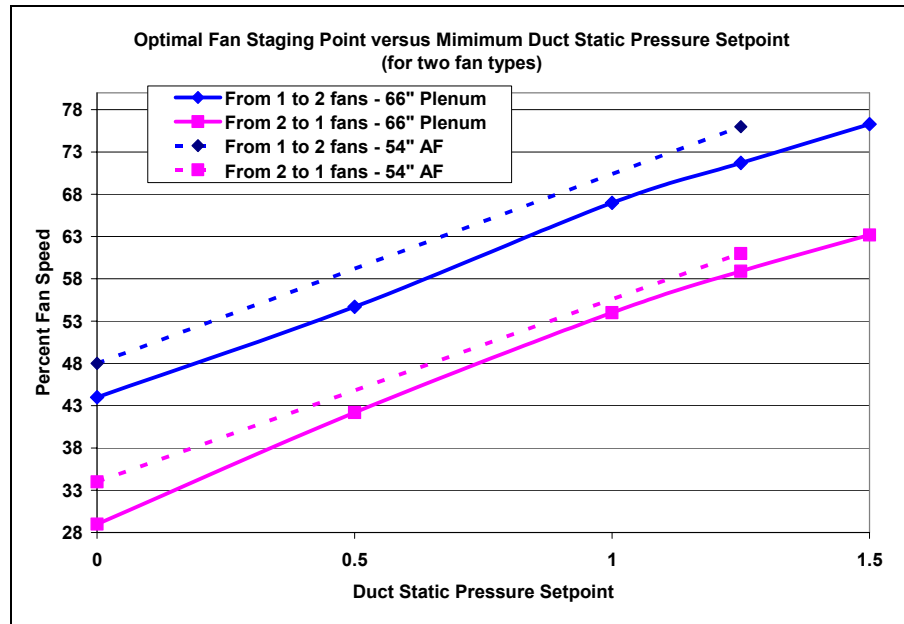

Figure 85. Optimal Staging Point for Two Fan Types

It may be tempting, after seeing how little difference there is between the kW lines in Figure 82 and Figure 83 at low loads, to simply operate two fans during all hours of operation. Besides the obvious waste of energy that would result, a few other problems exist with this strategy. One problem is operation in surge. Figure 86 shows that at low flow and relatively high fixed static, both fans are likely to operate in surge if the flow is divided between two fans, but if the load is carried by only one fan, then it is less likely to be operating in surge.

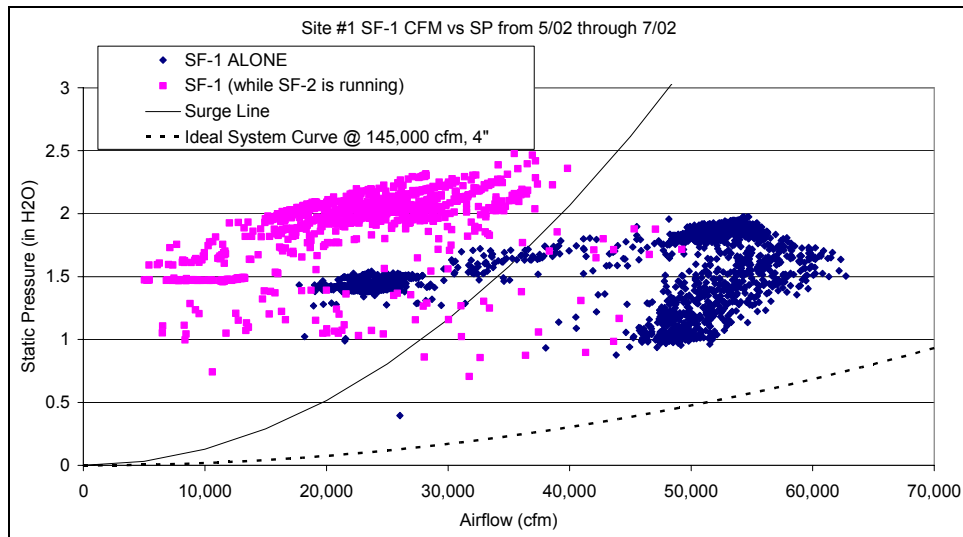

Figure 86. Parallel Fans in Surge

Another problem with operating parallel fans at low flows and high fixed static is “paralleling.” This phenomenon occurs with fan types that have flat spots or dips in the fan curves in the surge region, such as plenum fans, forward curved fans, or mixed flow fans. For example, as Figure 87 and Figure 88 illustrate, a 66” plenum fan with a speed signal of 680 RPM

operating against 5.5” of static pressure can produce as little as 45,000 CFM, as much as 56,000 CFM, or any point in between, which can lead to unstable operation. If two fans in parallel are operating in a flat spot on the curve, they can flip-flop back and forth, resulting in further instability.

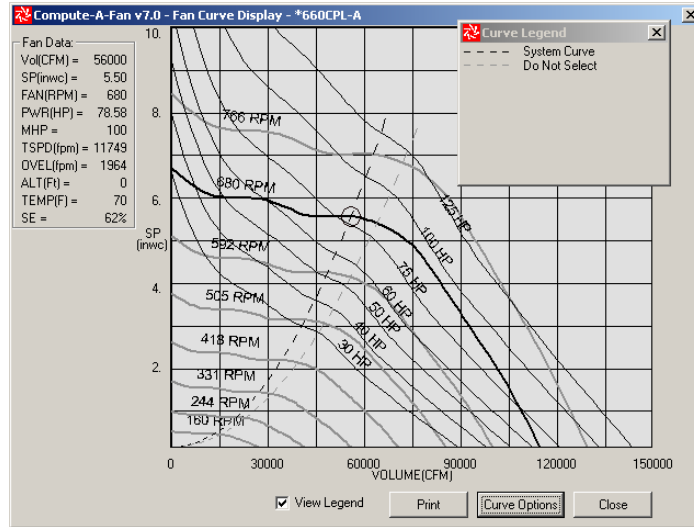

Figure 87. "Paralleling" - High Flow

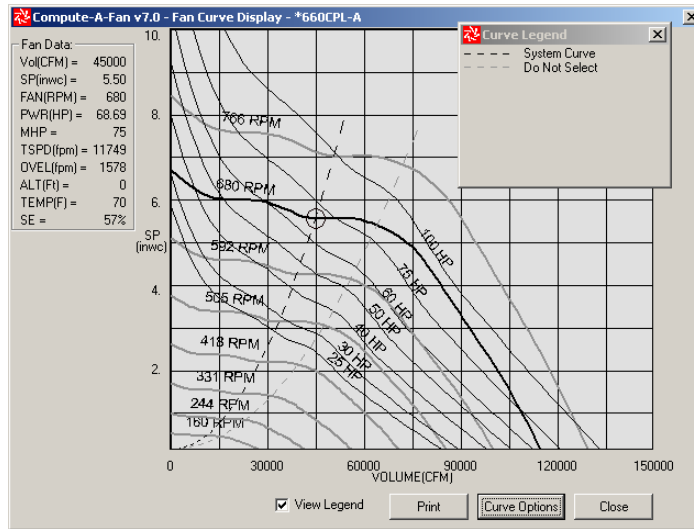

Figure 88. "Paralleling" - Low Flow

How To Isolate Fans in Parallel

Fans in parallel must be isolated, either with inlet cones, barometric backdraft dampers, or motorized backdraft dampers²⁹. Any type of isolation will add static pressure to the fan system, although to widely varying

²⁹ Excessive leakage through a fan that is OFF not only causes the ON fan to run harder but it will cause the OFF fan to spin backwards which can cause serious problems when the OFF fan is turned ON. If it is a single phase motor, the fan will start and spin in the wrong direction; it will move air in the right direction but very inefficiently. If it is a three phase fan with a VFD, it will probably lock the motor and then start spinning in the right direction, but it could trip the drive. If it is a direct drive fan with a three phase motor, an across-the-line start can shear the fan shaft and shatter the fan wheel and fan housing.

degrees, and will have some leakage rate that will also increase fan energy. Motorized backdraft dampers also add controls complexity and should generally be avoided.

Plenum fans are best isolated with inlet cones. These have very low-pressure drop when fully open and do not leak as much as backdraft dampers. Backdraft dampers also impart flow turbulence to the fan inlet that can reduce fan performance (system effect). Backdraft dampers can also add significantly to system pressure drop.

Conclusions

Static Pressure Reset

- *How* a fan is controlled is probably more important to fan energy than the *type* of fan selected. More specifically, demand-based static pressure setpoint reset has the potential to:
 - Reduce fan energy up to 50%.
 - Reduce fan operation in surge and thereby reduce noise, vibration, and bearing wear.
 - Improve control stability.
- If demand-based static pressure setpoint reset is not feasible or possible (e.g., no DDC controls at zone level), then the sensor should be located as far out in the system as possible and the SP setpoint should be as low as possible.

Fan Type

- Housed airfoil fans are usually more efficient than plenum fans, even if space constraints result in a poor discharge arrangement and system effects. The extra pressure drop on a housed airfoil fan has to be surprisingly high before it is less efficient than a plenum fan for the same application. However, noise and space constraints may still result in plenum fans as being the best choice.
- An airfoil fan selected near its peak efficiency will stay out of surge longer than a plenum fan selected near its peak efficiency, because housed airfoil fans peak well to the right of the surge line but plenum fans peak right at the surge line.
- In order to estimate annual fan energy, it is necessary to consider part load performance and how the fan is likely to be controlled.
 - Fan efficiency is fairly constant at part load if static pressure setpoint reset is successfully implemented. If not, part load fan efficiency depends on the fan type and size. Manufacturers' data can be combined with estimated system curves to develop part load fan performance curves.
 - Some estimate of the annual fan load profile is necessary to estimate annual fan energy (e.g., DOE-2 simulation).

Fan Sizing

- If there is a good chance that static pressure setpoint reset will be successfully implemented, fan sizing is fairly straightforward since fan efficiency remains fairly constant. If static pressure setpoint reset is not likely to be implemented, consider using a smaller fan (i.e., lower efficiency at design condition) because it will stay out of surge longer and the efficiency will actually improve as it rides down the system curve.

First Cost

- A fair comparison of fan types for built up systems should include the cost to construct the discharge plenum for plenum fans.
- Motor and VSD costs should also be considered since less efficient fans may require larger motors and drives.

Noise

- Not only are plenum fans inherently quieter than housed fans due to the attenuation of the discharge plenum, but they also work better with sound traps. A sound trap can be placed much closer to a plenum fan than to a housed fan.
- Parallel plenum fans can be fitted with inlet cones for very low pressure drop backdraft protection. This option is not generally available on housed fans, which must rely on backdraft dampers which have higher pressure drop but lower cost.
- Housed airfoil and other types of housed fans should not be ruled out on the basis of noise. Locate the air handler as far away from noise-sensitive spaces as possible. Use duct liner to attenuate noise. Use a sound trap, if necessary, but only if it can be located at least three duct diameters downstream of the fan.

Fan Staging

- While it may not be possible to know exactly what the minimum duct static pressure setpoint will be, a designer can use Figure 85 and his/her best guess of the min SP setpoint when writing the initial control sequence for staging parallel fans. That guess can then be refined based on monitored data in order to fine tune the optimal staging control sequence.
- Operating fans in parallel at low flow should be avoided, particularly if SP is not successfully reset. By dividing the flow in half, it pushes the fans into the surge region and can cause them to operate in particularly unstable areas within the surge region.

Coils and Filters

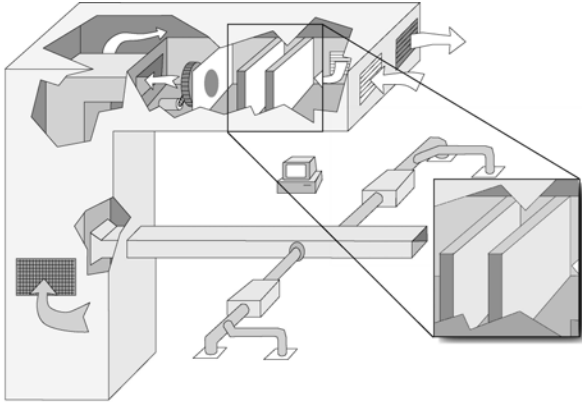

- Construction Filters
- Pre-Filters
- Final Filter Selection
- Filter Area
- Extended Surface Area Filters
- Monitoring Filters
- Coil Selection
- Coil Bypass

Construction Filters

If air handlers must be used during construction, filtration media with a Minimum Efficiency Reporting Value (MERV) of 6, as determined by ASHRAE 52.2-1999 should be used to protect coils and supply systems. Replace all filtration media immediately prior to occupancy.

Pre-Filters

Aside from pressure drop and added maintenance costs, pre-filters add little to a system. They are typically not effective in extending the life of the main filters as most dust passes through them. This is particularly true if final filters are changed frequently as is recommended below. Prefilters increase energy costs and labor costs (they generally have minor dust-loading capability and must be changed each quarter) and thus should be avoided.

Final Filter Selection

A reasonable selection for typical commercial applications is 80 percent to 85 percent dust spot efficiency (ASHRAE 52.1), MERV 12 (ASHRAE 52.2). Maximum initial pressure drop at 500 feet per minute should not exceed 0.60 inches water column. When selecting the fan, the mean air pressure drop (midway from clean to maximum) should be used. Filters should be changed long before they reach the maximum pressure drop is indicated by the filter manufacturer. More frequent change intervals (e.g. once per year) now being recommended by IAQ experts based on recent studies that have shown a significant reduction in perception of air quality as filters become dirty over relatively short time periods. The cause is likely from volatile organic compounds emitted from microbial growth on the dirt collected in the filter.

Filter Area

Filter banks in large built up air handlers as well as in custom or modular air handlers are sometimes installed with a blank-off panel to make up the difference between the filter bank area and the air handling unit casing area. If the entire cross sectional area of the air handler is filled with filters then pressure drop will be reduced and filter life will be extended. The energy and maintenance savings can pay for the added first cost in a reasonably short payback period.

Extended Surface Area Filters

Extended surface area filters are a new class of filters that have higher dust-holding capacity, longer life, and lower pressure drops. They are designed to fit conventional filter framing. While extended surface area filters cost more than standard filters they too may pay for themselves in energy and maintenance savings.

Monitoring Filters

Monitor pressure drop across filters via the DDC system so that an alarm can be triggered if filter pressure drop becomes excessive. Magnehelic gauges, or digital gauge now available on DDC differential pressure sensors, are also commonly used for visual indication of filter pressure drop.

The alarm in the DDC system on VAV systems should vary with fan speed (or inlet guide vane (IGV) signal) roughly as follows:

$$DP_x = DP_{100} (x)^{1.4}$$

where DP_{100} is the high limit pressure drop at design cfm and DP_x is the high limit at speed (IGV) signal x (expressed as a fraction of full signal). For instance, the setpoint at 50% of full speed would be $(.5)^{1.4}$ or 38% of the design high limit pressure drop.

While filters will provide adequate filtration up to their design pressure drop, odors can become a problem well before a filter reaches its design pressure drop. For this reason and for simplicity of maintenance, filters are typically replaced on a regular schedule (e.g. every 12 or 18 months).

Coil Selection

Many designers select cooling coils for a face velocity of 550 fpm. However, it is well worth looking at lower face velocity coil selection ranging from 400 fpm to 550 fpm and selecting the largest coil that can reasonably fit in the allocated space. Table 22 shows a range of coil selections for each of the five monitored sites. The design selections in this table are shown with yellow highlights. The blue highlights indicate flat blade coils, and the rest of the selections are wavy fin coils.

Table 22. Alternate Coil Selections for All Five Monitored Sites

Site	Coil Dimensions		Area (ft²)	FPM (Face velocity)	ROWS	FPI (fins per in.)	Capacity (kBH)		AIR SIDE (Pressure drop)	WATER SIDE	
	Height (in.)	Length (in.)					Total	Sensible	(in.)	GPM (Flow)	DP (ft.) (Pressure drop)
#1	36	120	30.0	537	6	10	466	426	0.74	68	16
	42	120	35.0	460	6	10	471	428	0.31	68	12.6
	42	120	35.0	460	6	10	468	429	0.55	68	10.8
	48	120	40.0	403	6	10	482	436	0.25	68	10.3
	48	120	40.0	403	6	10	491	443	0.47	68	10.3
#2	42.25	146	42.9	544	5	12	781	670	0.91	133	12.4
	48.5	146	49.0	476	6	9	796	679	0.72	133	8.3
	57.5	146	58.3	400	5	10	790	671	0.5	133	6.4
#3	49.5	74	25.4	472	6	10	403	358	0.79	50	2.3
	57.5	74	29.5	406	6	10	409	362	0.61	50	1.4
#4	39.25	140	38.2	524	4	10	492	410	0.6	81	2
	42.25	140	41.1	486	4	10	496	413	0.54	81	1.9
	51.5	140	50.1	399	4	10	500	418	0.4	81	0.9
#5	36	108	27.0	555	3	14	440	419	0.73	63.6	25.7
	42	108	31.5	476	6	10	483	445	0.33	63.6	10.3
	42	108	31.5	476	5	11	468	436	0.54	63.6	8.9
	51	108	38.3	392	5	10	477	438	0.2	63.6	18.2
	51	108	38.3	392	5	9	472	435	0.34	63.6	18.2

For Site #1, increasing the coil bank height from 36" to 42" reduced the airside pressure drop from 0.74" w.c. to 0.31" w.c. and lowered the annual fan energy from 3% with fixed static setpoint to 5% with demand based reset. This coil selection also reduced the waterside pressure drop by 3.4', which may or may not have an impact on pumping energy depending on the piping configuration. In addition to reducing the fan energy, the drop in static pressure can also reduce fan noise.

Most air handler manufacturers offer multiple coil sizes for a given air handler casing size. Selecting the largest coil for a particular casing can have a significant impact on fan energy and a minimal impact on first cost. However, for a supplier in a competitive situation, it can be the difference between winning or losing a job. Therefore, the designer needs to be specific enough in the construction documents to force the larger coil selection.

It is important to read the messages from the manufacturer's selection program when selecting a coil. They will provide warnings if the velocity and fin design pose any risk of condensate carryover.

ASHRAE Standard 62 recommends selecting coils for under 0.75" w.c. for ease of coil cleaning, since both the number of rows and the fin spacing contribute to the difficulty of accessing the fins.

Coils should also be selected for true counter flow arrangements. At low loads, interlaced and multi-inlet coils can lead to a drop in the low differential coil temperatures. This so-called "Degrading ΔT syndrome" causes central plants to run inefficiently due to increased pumping and inefficient staging of chillers.

Coils should be selected for the same ΔT as the chilled water plant but all coils in a chilled water system do not have to be selected for the exact same ΔT as long as the weighted average ΔT matches the plant.

All coils should have access doors upstream and, for larger coils (>2 rows), downstream as well. This allows the coils to be cleaned and inspected, both of which are critical for performance and IAQ. It also ensures that control sensors can be located appropriately. For example, the freeze stat on a 100% OA system with a preheat coil must be located between the preheat coil and the cooling coil.

Coil Bypass

For coil banks in large built-up VAV systems, consider placing a bypass damper between coil sections where the intermediate coil headers are located. Since this space is already allocated for piping, it provides a low-cost option to further reduce the fan pressure drop. The bypass will open except the cooling coil is active. Airfoil damper blades (rather than vee-groove blades) should be used for velocities over 1500 fpm.

Outside Air/Return Air/Exhaust Air Control

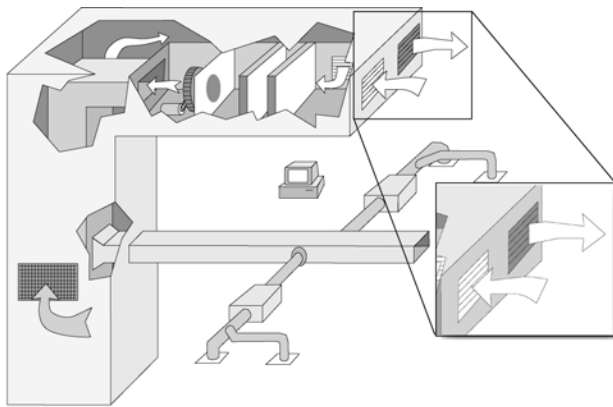

- Control of Minimum OSA for VAV
- Design of Airside Economizer Systems
- Economizer Temperature Control
- Economizer High-limit Switches

This section describes the design of airside economizers, building pressurization controls, and control for code-required ventilation in a VAV system.

Control of Minimum outdoor air for VAV Systems.

Ventilation that meets Title 24 minimums is required for all spaces when they are normally occupied (§121 (c) 1.). Furthermore, the proposed 2005 version of the Standard mandates that VAV systems be tested for code-required ventilation both at design supply airflow and with all VAV boxes at minimum position. Although providing code-minimum ventilation throughout the range of system operation is implied by the existing standard, systems are rarely designed to achieve this, so this section provides guidance on designing VAV systems to dynamically adjust outdoor airflow.

Figure 89 depicts a typical VAV system. In standard practice, the TAB contractor sets the minimum position setting for the outdoor air damper during construction. It is set under the conditions of design airflow for the system, and remains in the same position throughout the full range of system operation.

Does this meet code? The answer is no. As the system airflow drops so will the pressure in the mixed air plenum. A fixed position on the minimum outdoor air damper will produce a varying outdoor airflow. As depicted in Figure 89, this effect will be approximately linear (in other words outdoor air airflow will drop directly in proportion to the supply airflow).

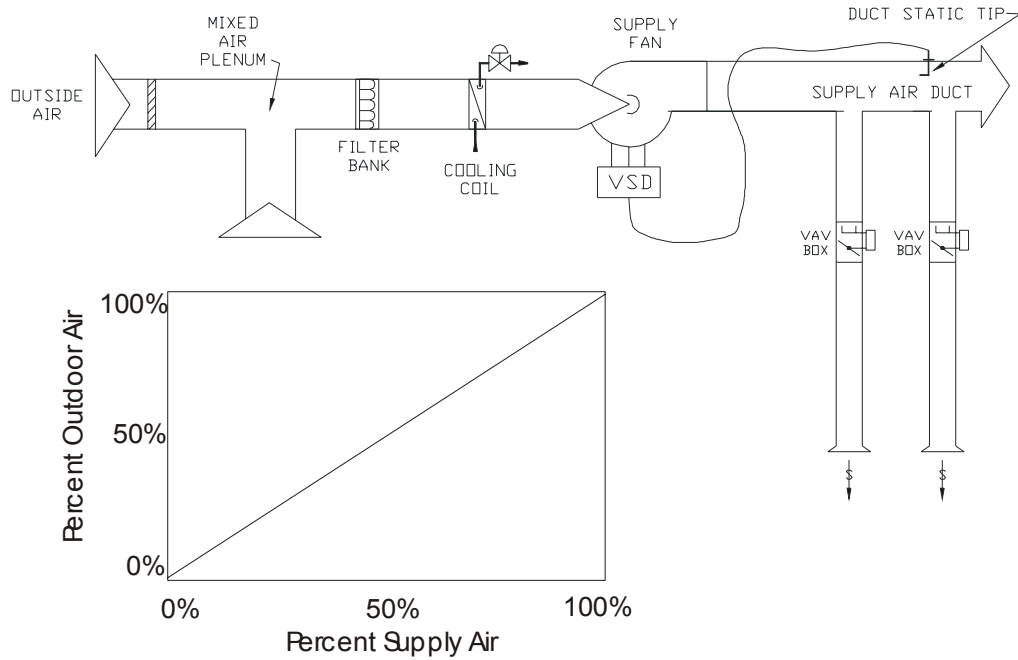

Figure 89. VAV Reheat System with a Fixed Minimum outdoor air Damper Setpoint

This section presents several methods used to dynamically control the minimum outdoor air in VAV systems, which are summarized in Table 23 and described in detail below.

Table 23. Summary of Minimum outdoor air Control Strategies

Method	Figure	Description
Fixed minimum damper setpoint	Figure 89	This method does not comply with Title 24; the airflow at a fixed minimum damper position will vary with the pressure in the mixed air plenum.
Dual minimum damper setpoint at maximum and minimum supply air rates	–	This method complies with the letter of Title 24 but is not accurate over the entire range of airflow rates and when there are wind or stack effect pressure fluctuations.
Energy balance method	Figure 90	This method does not work for two reasons: 1) inherent inaccuracy of the mixed air temperature sensor, and 2) the denominator of the calculation amplifies sensor inaccuracy as the return air temperature approaches the outdoor air temperature.
Return fan tracking	Figure 91	This approach does not work because the cumulative error of the two airflow measurements can be large, particularly at low supply/return airflow rates.
Airflow measurement of the entire outdoor air inlet	Figure 92	This method may or may not work depending on the airflow measurement technology. Most airflow sensors will not be accurate to a 5%-15% turndown (the normal commercial ventilation range).
Injection fan with dedicated minimum ventilation damper	Figure 93	This approach works, but is expensive and may require additional space.
Dedicated minimum ventilation damper with pressure control	Figure 94	This successful approach is the recommended method of control.

An inexpensive enhancement to the fixed damper setpoint design is the dual minimum setpoint design, commonly used on some packaged AC units. The minimum damper position is set proportionally based on fan speed or airflow between a setpoint determined when the fan is at full speed (or airflow) and minimum speed (or airflow). This method complies with the letter of Title 24 but is not accurate over the entire range of airflow rates and when there are wind or stack effect pressure fluctuations. But with DDC, this design has very low costs.

The energy balance method (Figure 90) uses temperature sensors in the outside, as well as return and mixed air plenums to determine the percentage of outdoor air in the supply air stream. The outdoor airflow is then calculated using the equations shown in Figure 90. This method requires an airflow monitoring station on the supply fan.

This approach does not generally work for several reasons:

1. The accuracy of the mixed air temperature sensor is critical to the calculation but is very difficult to perform with any precision in real applications. Even with an averaging type bulb, most mixing plenums have some stratification or horizontal separation between the outside and mixed airstreams.³⁰

³⁰ This was the subject of ASHRAE Research Project 1045-RP, “Verifying Mixed Air Damper Temperature and Air Mixing Characteristics.” Unless the return is over the outdoor air there are significant problems with stratification or airstream separation in mixing plenums.

2. Even with the best installation, high accuracy sensors, and field calibration of the sensors, the equation for percent outdoor air will become inaccurate as the return air temperature approaches the outdoor air temperature. When they are equal, this equation predicts an infinite percentage outdoor air.
3. The accuracy of the airflow monitoring station at low supply airflows is likely to be low.

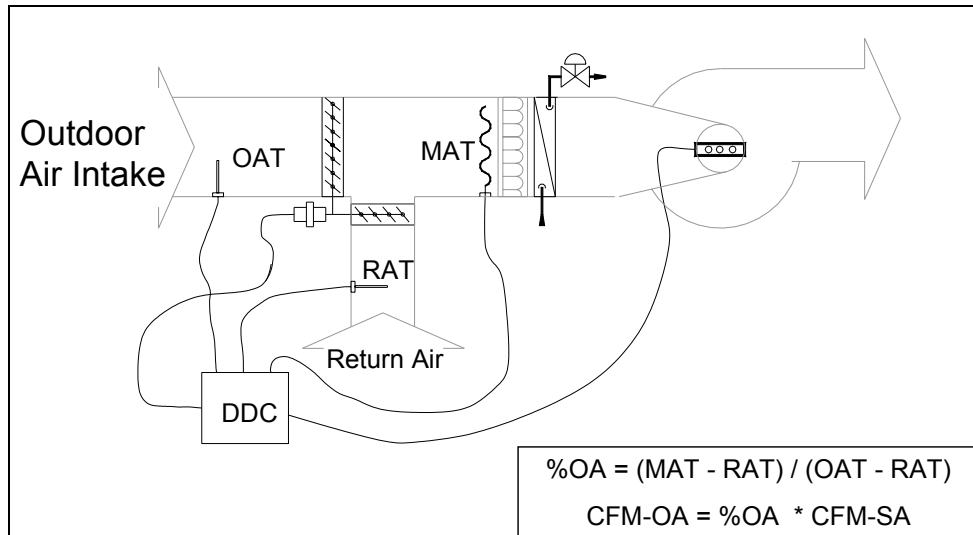

Figure 90. Energy Balance Method of Controlling Minimum outdoor air

Return fan tracking (Figure 91) uses airflow monitoring stations on both the supply and return fans. The theory behind this is that the difference between the supply and return fans has to be made up by outdoor air, and controlling the flow of return air forces more ventilation into the building. Several problems occur with this method: 1) the relative accuracy of airflow monitoring stations is poor, particularly at low airflows; 2) the cost of airflow monitoring stations; 3) it will cause building pressurization problems unless the ventilation air is equal to the desired building exfiltration plus the building exhaust. ASHRAE research has also demonstrated that in some cases this arrangement can cause outdoor air to be drawn into the system through the exhaust dampers due to negative pressures at the return fan discharge.

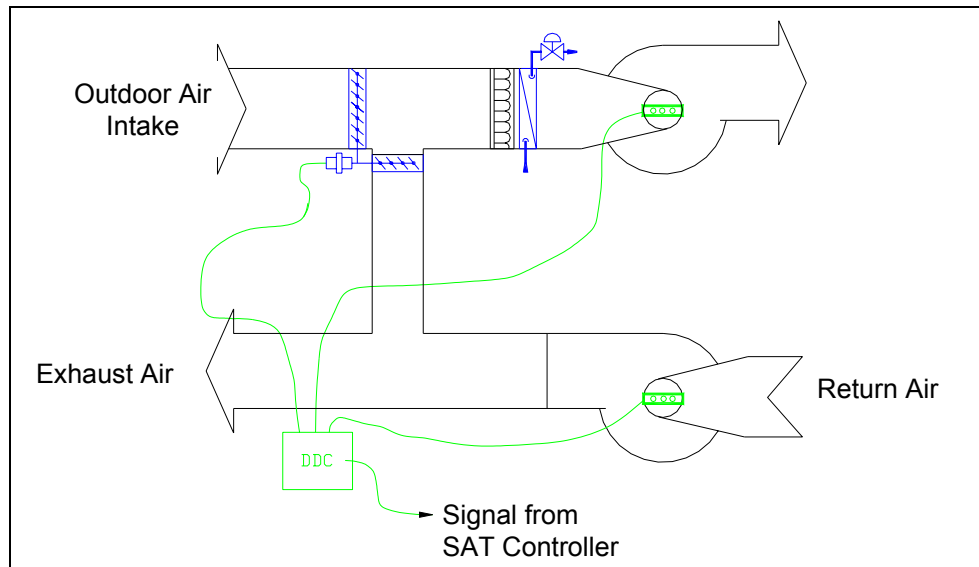

Figure 91. Return Fan Tracking

Controlling the outdoor air damper by direct measurement with an airflow monitoring station (Figure 92) can be an unreliable method. Its success relies on the turndown accuracy of the airflow monitoring station. Depending on the loads in a building, the ventilation airflow can be between 5% and 15% of the design airflow. If the outdoor airflow sensor is sized for the design flow for the airside economizer, this method has to have an airflow monitoring station that can turn down to the minimum ventilation flow (between 5% and 15%). Of the different types available, only a hot-wire anemometer array is likely to have this low-flow accuracy while traditional pitot arrays will not. (Refer to Section 3.5.3 of the PECCI Control System Design Guide for a comparison of air flow measurement technologies.) One advantage of this approach is that it provides outdoor airflow readings under all operating conditions, not just when on minimum outdoor air.

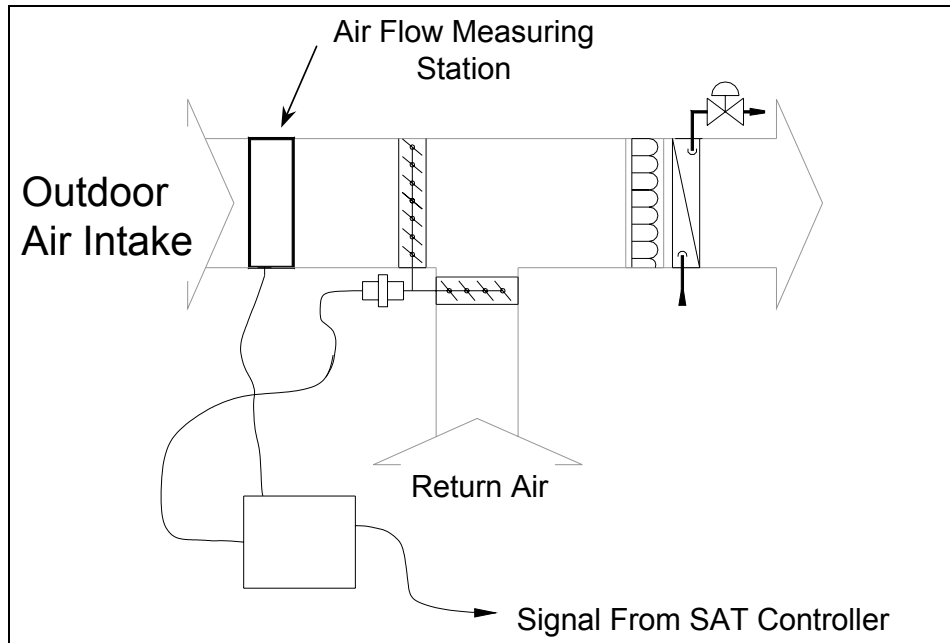

Figure 92. Airflow Measurement of 100% outdoor air

The injection fan method (Figure 93) uses a separate outdoor air inlet and fan sized for the minimum ventilation airflow. This inlet contains an airflow monitoring station, and a fan with capacity control (e.g. discharge damper; VFD) which is modulated as required to achieve the desired ventilation rate. The discharge damper is recommended since a damper must be provided anyway to shut off the intake when the AHU is off, and also to prevent excess outdoor air intake when the mixed air plenum is very negative under peak conditions. (The fan is operating against a negative differential pressure and thus cannot stop flow just by slowing or stopping the fan.) This method works, but the cost is high and often requires additional space for the injection fan assembly.

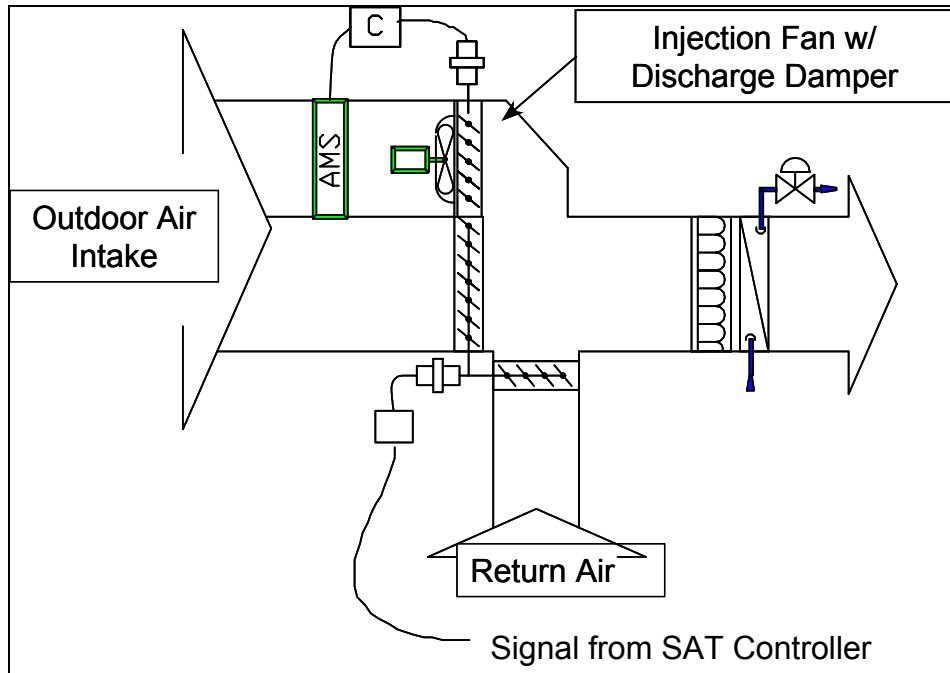

Figure 93. Injection Fan with Dedicated Minimum outdoor air Damper

An inexpensive but effective design uses a minimum ventilation damper with differential pressure control (Figure 94). In this method, the economizer damper is broken into two pieces: a small two position damper controlled for minimum ventilation air and a larger, modulating, maximum outdoor air damper that is used in economizer mode. A differential pressure transducer is placed across the economizer damper section measuring the pressure in the mixing plenum with the outside as a reference. During start-up, the air balancer opens the minimum OA damper and return air damper, closes the economizer OA damper, runs the supply fan at design airflow, measures the OA airflow (using a hand-held velometer) and adjusts the minimum OA damper position until the OA airflow equals the design minimum OA airflow. The linkages on the minimum OA damper are then adjusted so that the current position is the “full open” actuator position. At this point the DP across the minimum OA damper is measured. This value becomes the DP setpoint. The principle used here is that airflow is constant across a fixed orifice (the open damper) at fixed DP.

As the supply fan modulates when the economizer is off, the return air damper is controlled to maintain the design pressure DP setpoint across the minimum ventilation damper. (Refer to ASHRAE Guideline 16 for damper type and sizing in this scheme.)

The main downside to this method is the complexity of controls. A control sequence for this scheme follows:

Minimum outdoor air control

Open minimum outdoor air damper when the supply air fan is proven on and the system is not in warm-up, cool-down, setup, or setback mode. Damper shall be closed otherwise.

The minimum differential pressure setpoint across the mixed air plenum (MinDP) is determined by the air balancer as required to maintain the design minimum outdoor airflow rate across the minimum outdoor air damper with the supply air fan at design airflow. See below for return air damper control of mixed air plenum pressure.

Return air dampers

When the economizer is locked out from the economizer high limit control (see Economizer High-Limit Switches), the return air damper signal is modulated to maintain differential pressure across the outdoor air damper at setpoint (MinDP_{sp}) determined above.

When the economizer is in control, the return air damper is sequenced with the outdoor air economizer damper as described in the section, Economizer Temperature Control.

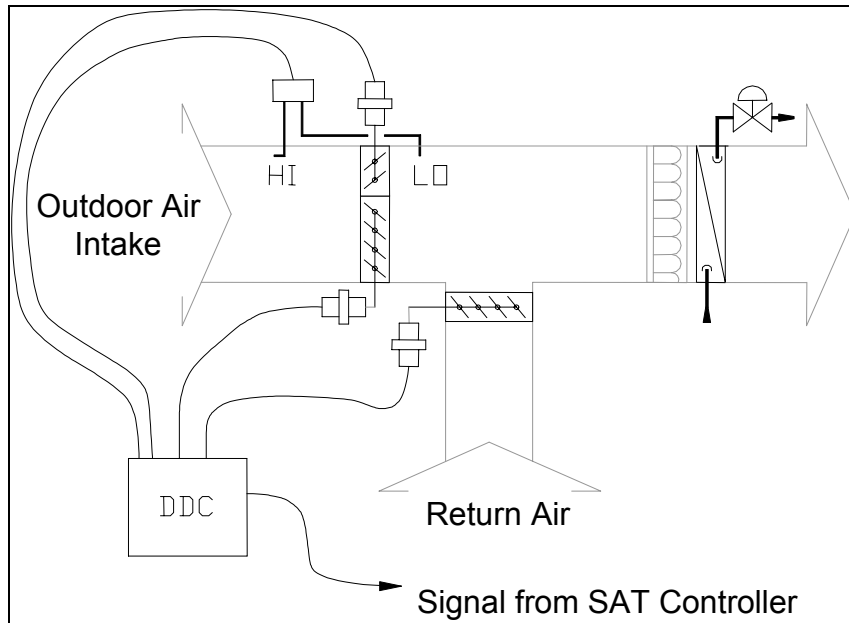

Figure 94. Minimum outdoor air Damper With Pressure Control

Regardless of how the minimum ventilation is controlled, care should be taken to reduce the amount of outdoor air provided when the system is operating during the weekend or after hours with only a fraction of the zones active. Title 24, section 122(g) requires provision of “isolation zones” of 25,000 ft² or less. This can be provided by having the VAV boxes return to fully closed when their associated zone is in unoccupied mode. When a space or group of spaces is returned to occupied mode (e.g. through off-hour scheduling or a janitor’s override) only the boxes serving those zones need to be active. During this partial occupancy the ventilation air can be reduced to the requirements of those zones that are active. If all zones are of the same occupancy type (e.g. private offices), simply assign a floor area to each isolation zone and prorate the minimum ventilation are by the ratio of the sum of the floor areas presently active divided by the sum of all the floor areas served by the HVAC system.

For our recommended control scheme with a separate minimum outdoor air damper, this same area ratio can be used to reduce the design pressure drop setpoint $MinDP_{sp}$ across the economizer section from the design setpoint $MinDP$.

$$MinDP_{sp} = MinDP \left[\frac{A_{active}}{A_{total}} \right]^2$$

where A_{active} is area of active Isolation Areas and A_{total} is the overall floor area served by the system. The Contractor shall calculate the floor area of Isolation Areas from drawings.

Design of Airside Economizer Systems

Title 24 has a prescriptive requirement for economizers on all air-conditioning systems with cooling capacities greater than 6.5 tons. Although waterside economizers can be used to meet this requirement, airside economizers are generally more cost effective and always more energy efficient in California climates. For built-up VAV systems, an exception to this rule is floor-by-floor air-handling units served by a central ventilation shaft where insufficient space exists to provide 100% outdoor air for the units. In this case, either water-cooled units or chilled water units with a water-side economizer is generally a better solution. Water-side economizers may also be more effective for areas requiring high humidity levels (>30%) since the increase in humidifier energy can offset the cooling savings.

This section deals with design, configuration, and control of airside economizer systems. The ASHRAE Guideline 16-2003 “Selecting Outdoor, Return, and Relief Dampers for Airside Economizer Systems,” available at <http://www.ashrae.org>, contains practical and detailed information on damper selection and guidance on control of economizer dampers. This guideline purposely does not cover many of the topics addressed by Guideline 16 (e.g. recommended damper configuration and sizing). Readers are encouraged to purchase a copy from ASHRAE.

Configuration of dampers for adequate mixing of outside and return air streams is the subject of the ASHRAE Research Project 1045-RP, “Verifying Mixed Air Damper Temperature and Air Mixing Characteristics.” This study found somewhat improved mixing when the return air was provided on the roof of the mixing plenum over the outdoor air rather than side-by-side or opposite wall configurations. There were no strong trends or generalizations observed among design options such as damper blade length, blade orientation, and face velocity. Fortunately, in most mild California climates, mixing effectiveness is not a significant issue.

Common to all airside economizer systems is the need to relieve up to 100% design airflow minus anticipated exfiltration and building exhaust, due to the fact that the economizer could be providing up to 100% outdoor air. Exfiltration to maintain a mild pressurization (between 0.03” to 0.08” above ambient) in a typical commercial building can be assumed to be approximately 0.05 to 0.15 cfm/ft².

Economizers can be designed with barometric relief, relief fan(s), or return fan(s) (Figure 95), Figure 96 and Figure 97). The choice of system return/relief path configuration is usually driven by a number of design

issues including physical space constraints, the pressure drop in the return path, the need for interspatial pressurization control, acoustics and others. From an energy standpoint, the choices in order of preference (from most efficient to least efficient) are as follows: barometric relief (Figure 95), relief fans (Figure 96) and return fans (Figure 97). Each of these options are described below.

While always the most efficient choice, barometric relief (Figure 95) may not be the most cost effective choice. To work effectively barometric dampers must be chosen for low-pressure drop (typically a maximum of 0.08" w.c. from the space to ambient) at relatively high flow rates. As a result, the barometric relief openings can be excessively large -- a challenge to the architectural design. Where barometric relief is used, the relief may be provided anywhere within the areas served by the central system.

In addition to energy savings, another advantage of barometric relief is the simplicity of controls for building pressurization, since no automatic control is required. A distinct disadvantage is that it only works for low-pressure returns, typically limiting it to low-rise projects.

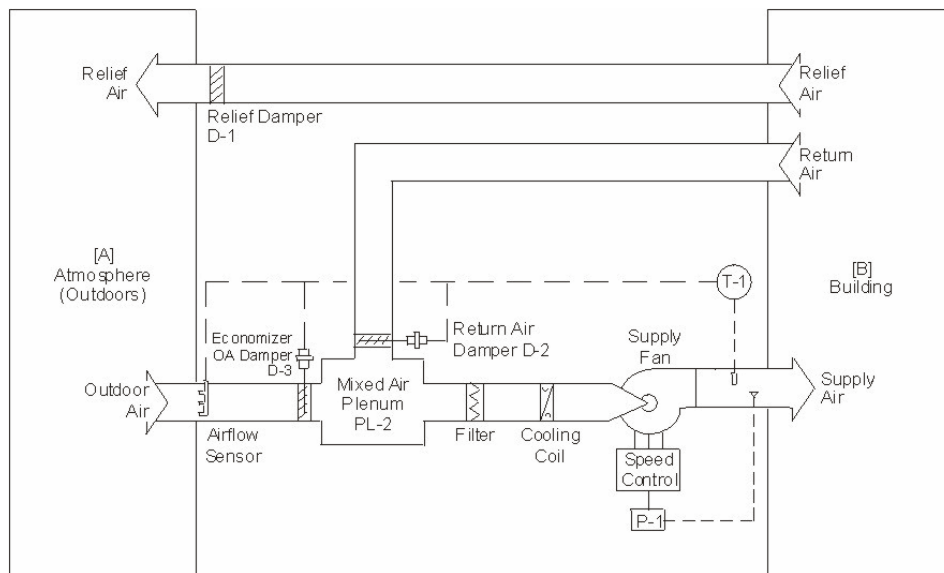

Figure 95. Airside Economizer Configuration with Barometric Relief from ASHRAE Guideline 16-2003

Where barometric relief is not an option, relief fans (Figure 96) are the best bet. Relief fans always use less energy than return fans and can incorporate barometric relief as the first stage of building pressure control (see sequence below). In addition to the energy benefits, relief fans are relatively compact, reducing impact on space planning and architectural design. The two largest limitations are acoustics and static pressure. Acoustical control can usually be achieved by placing the relief fans out of the line of site from the return shaft. Systems with high return pressures (e.g., ducted returns) will generally require return fans.

The following is an example control sequence for a system with two relief fans and an automated damper at each:

Relief system shall only be enabled when the associated supply fan is proven on and the minimum outdoor air damper is open.

Building static pressure shall be time averaged with a sliding five-minute window (to reduce damper and fan control fluctuations). The averaged value shall be that displayed and used for control³¹.

A PI loop maintains the building pressure at a setpoint of 0.05" with an output ranging from 0% to 100%. The loop is disabled and output set to zero when the relief system is disabled. When the relief system is enabled, open the motorized dampers to both relief fans (this provides barometric relief for the building). When the PI loop is above 25%, start one relief fan (lead fan) and assign the fan %-speed analog output to the PI loop output; and close the discharge damper of the adjacent relief fan (to prevent backflow). Lead fan shall shut off when PI loop falls below 15% for five minutes (do not limit speed signal to the motor – operating below 15% speed for 5 minutes should not overheat motor³²). Start lag fan and open its discharge damper when PI output rises above 50%. Stop lag fan and shut its damper after fan has operated for at least 5 minutes and PI loop output falls below 40%. Fan speed signal to all operating fans shall be the same.

Note that this sequence first opens the relief dampers before staging the fans on, which saves considerable energy since at low loads, barometric relief is all that is required.

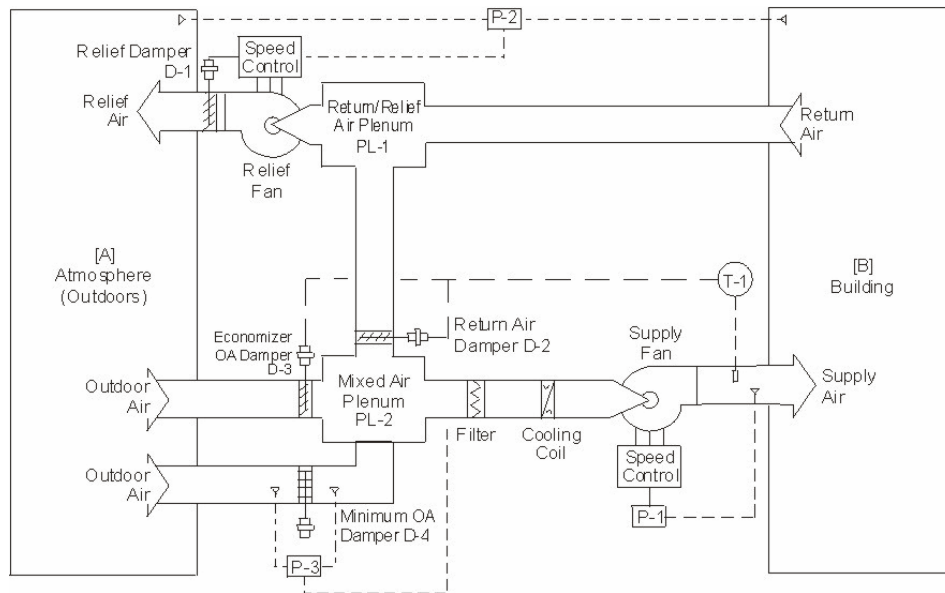

Figure 96. Airside Economizer Configuration with Relief Fan from ASHRAE Guideline 16-2003

- ³¹ A single building static pressure sensor is usually sufficient, or one per wing or tower for large, irregularly shaped buildings. The high side should be in an interior space on the second floor (first floor is too variable due to lobby doors). Do not tap into a single tube in multiple locations in order to get an average signal. The pressure differences between the various taps creates a flow in the tube and a false reading.
- ³² Minimum motor speed limitations to ensure proper motor cooling have not been well studied. ABB suggests a minimum of 10% (6 Hz) for pump and fan applications where power drops nearly as the cube of airflow. Other manufacturers suggest there is no minimum speed for these applications provided it is acceptable that motor surface temperatures become hot enough to cause burns if touched. Still others suggest minimum speeds as high as 20 Hz, particularly for TEFC motors commonly used for outdoor applications. Our own experience is that 10% (6 Hz) provides adequate cooling for long term operation and there is no minimum speed for short term operation.

Return fans (Figure 97) should only be used for projects with high static pressure requirements (e.g., ducted returns or the need for sound traps). They will always use more energy than relief fans, will generally cost more to install, and will add to the complexity of the control system.

A sample sequence of control for return fans follows. In this sequence, the return fan speed is modulated to control the pressure in the return/relief air plenum and the exhaust/relief damper is controlled to maintain building static pressure. This sequence ensures that adequate return airflow can be provided when the economizer is off, and that the system can provide 100% outdoor air and maintain the desired building static pressure when the economizer is on.

Example return fan sequence:

Return fan operates whenever associated supply fan is proven on.

Return fan speed shall be controlled to maintain return fan discharge static pressure at setpoint. The setpoint shall be determined in conjunction with the air balancer as the larger of the following:

That required to deliver the design return air volume across the return air damper when the supply air fan is at design airflow and on minimum outdoor air.

That required to exhaust enough air to maintain space pressure at setpoint (0.05") when the supply air fan is at design airflow and on 100% outdoor air.

Relief/exhaust dampers shall only be enabled when the associated supply and return fan are proven on and the minimum outdoor air damper is open. The relief/exhaust dampers shall be closed when disabled.

Building static pressure shall be time averaged with a sliding five-minute window (to reduce damper and fan control fluctuations). The averaged value shall be that displayed and used for control.

When the relief/exhaust dampers are enabled, they shall be controlled by a PI loop that maintains the building pressure at a setpoint of 0.05". (Due the potential for interaction between the building pressurization and return fan control loops, extra care must be taken in selecting the PI gains. ASHRAE Guideline 16-2003 recommends that the closed loop response time of the building pressurization loop should not exceed one-fifth the closed loop response time of the return fan control loop to prevent excessive control loop interaction. This can be accomplished by decreasing the gain of the building pressurization controller.)

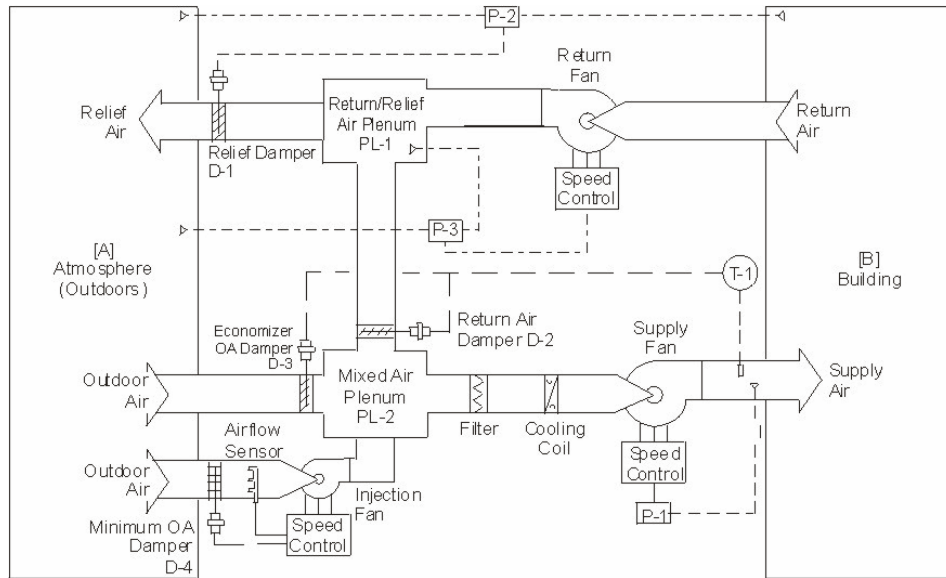

Figure 97. Airside Economizer Configuration with Return Fan from ASHRAE Guideline 16-2003

Economizer Temperature Control

Most economizer control sequences stage the outdoor and return dampers in tandem, with the return dampers closing as the outdoor dampers open. Although this sequence works, fan energy savings can be achieved by staging these dampers in series (see Figure 98). In this staged sequence, the outdoor air damper is opened as the first stage of cooling, while the return damper remains open (provided that the economizer is operating). This sequence provides less than 100% outdoor air but a very low-pressure air path for the supply fan. If this is sufficient to cool the building, energy savings will result from the reduced fan pressure. If more cooling is needed, the return damper is modulated closed to ensure that the system has 100% outdoor air. ASHRAE Guideline 16 recommends this sequence.

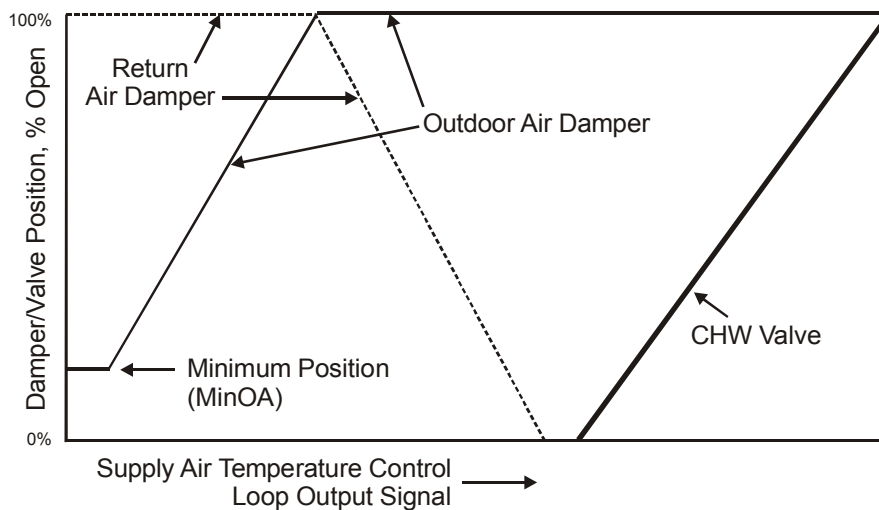

Figure 98. Airside Economizer Control Staging from ASHRAE Guideline 16-2003

Economizer High-Limit Switches

Title 24 has requirements for economizer high-limit switches. The high-limit switch is the control that disables the economizer when the outdoor air is warmer (or has higher enthalpy) than the return air. This requirement was based on a detailed study on the energy performance of high-limit switches done by ASHRAE's Standard 90.1 committee in development of the 1999 Standard.

Table 24 presents the requirements by climate zone from Title 24. This table has five different high-limit controls (identified as devices) including fixed and differential dry-bulb temperature, fixed and differential enthalpy, and electronic enthalpy. Fixed dry-bulb and enthalpy controls use a fixed reference for return air temperature rather than a direct measurement. Differential controls provide a measurement both outside and in the return air stream.

Table 24. High Limit Switch Requirements from Title 24.

Device Type	Climate Zones	Required High Limit (Economizer Off When):	
		Equation	Description
Fixed Dry Bulb	01, 02, 03, 05, 11, 13, 14, 15, & 16 04, 06, 07, 08, 09, 10 & 12	$T_{OA} > 75^{\circ}\text{F}$	Outside air temperature exceeds 75° F
		$T_{OA} > 70^{\circ}\text{F}$	Outside air temperature exceeds 70°
Differential Dry Bulb	All	$T_{OA} > T_{RA}$	Outside air temperature exceeds return air temperature
Fixed Enthalpy ^c	04, 06, 07, 08, 09, 10 & 12	$h_{OA} > 28 \text{ Btu/lb}^b$	Outside air enthalpy exceeds 28 Btu/lb of dry air ^b
Electronic Enthalpy	All	$(T_{OA}, RH_{OA}) > A$	Outside air temperature/RH exceeds the "A" set-point curve ^a
Differential Enthalpy	All	$h_{OA} > h_{RA} >$	Outside air enthalpy exceeds return air enthalpy

a Set point "A" corresponds to a curve on the psychometric chart that goes through a point at approximately 75°F and 40% relative
b At altitudes substantially different than sea level, the Fixed Enthalpy limit value shall be set to the enthalpy value at 75°F and 50%
c Fixed Enthalpy Controls are prohibited in climate zones 01, 02, 03, 05, 11, 13, 14, 15 & 16

The electronic enthalpy device measured is a Honeywell controller that is used in packaged equipment. As shown in Figure 99, it acts like a dry bulb controller at low humidity and an enthalpy controller at high humidity. This device is only available as a fixed reference and offers four switch selectable reference curves for the return.

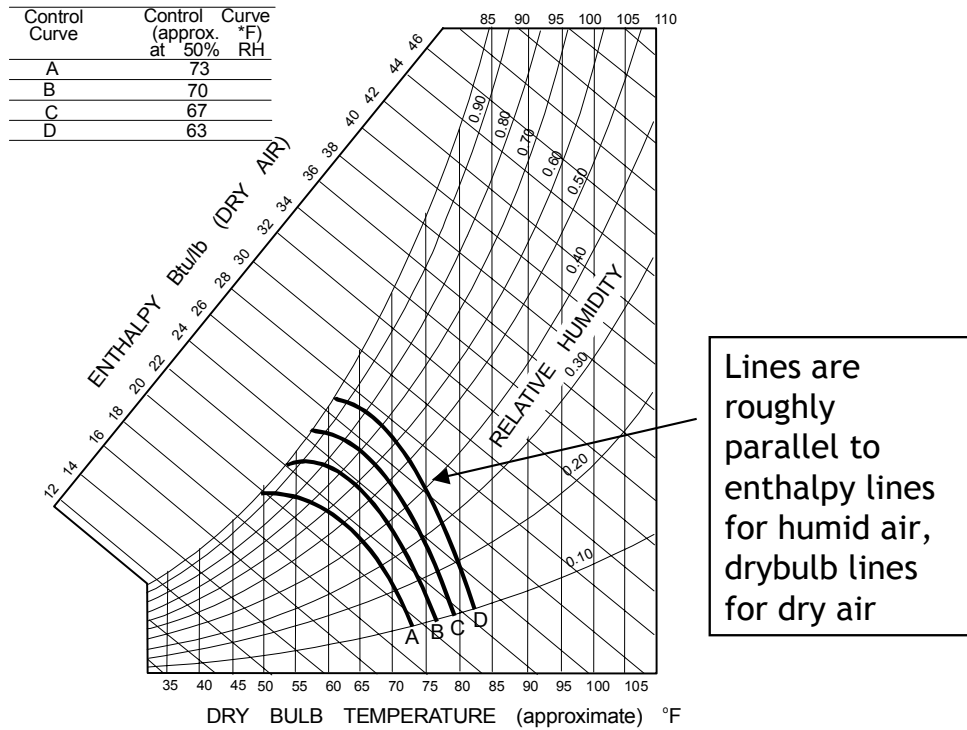

Figure 99. Electronic Enthalpy High Limit Controller.

Of all of the options, dry bulb temperature controls prove the most robust as dry-bulb temperature sensors are easy to calibrate and do not drift excessively over time. Differential control is recommended throughout California and the sensors should be selected for a through system resolution of 0.5°F. Dry-bulb sensors work well in all but humid climates, which are not typical in California.

Differential enthalpy controls are theoretically the most energy efficient. The problem with them is that the sensors are very hard to keep calibrated and should be recalibrated on an annual or semi-annual basis. Contrary to common perception, enthalpy controls do not work in all climates. In hot dry climates they can hunt and excessively cycle the economizer dampers when the hot dry outdoor air has lower enthalpy than the space(s) at cooling balance point. What happens is that the economizer opens up and the coil is dry, which in turn dries out the space(s) until the return enthalpy goes below the outdoor enthalpy. As a result, the economizer damper closes, the space humidity increases, and the cycle repeats.

Appendix 1 – Monitoring Sites

Table 25. Summary of Monitoring Site Characteristics

	Site 1	Site 2	Site 3	Site 4	Site 5
Type	Office	Office	Office	Courthouse	Office
Floor Area (ft ²)	105,000	307,000	955,000	570,000	390,000
Stories	3	12	25	16	6/8
Location	San Jose, CA	San Jose, CA	Sacramento, CA	Sacramento, CA	Oakland, CA
Owner	Private	Private	Public	Public	Public
Occupant	Owner-occupied	Tenant	Public Tenant	Public Tenant	Public Tenant
Fan Type	Two Centrifugal Plenum	Four Centrifugal, Housed	Centrifugal, Plenum, Two per Floor	Centrifugal, Plenum, Two per Floor	Six Centrifugal, Housed
Cooling Total Tons	500	800	2,300	1,700	1,000

Site 1



Figure 100. Site #1 – Office Building in San Jose

- Occupancy type: Office, owner occupied, with data center.
- Location: San Jose, California.

- Floor area: 105,000 ft².
- Number of stories: Three.
- Occupancy date: October 1999.
- Built-up air handling unit with two 66" plenum fans with airfoil blades (Cook 660-CPLA) with barometric back draft dampers on the inlets. Each fan has a 75 HP motor and was designed for approximately 70,000 cfm at 4" wc. These fans are operated 24/7 to serve several computer rooms.
- There are six relief fans with 5 HP motors controlled in two groups of three, with a variable speed drive for each group.
- Two hot-water unit heaters (containing hot water coils and fans) are located in the mixed air plenum to provide preheat. No additional heating coils are located in the air-handler.
- Chilled water plant: Two centrifugal, VSD, water-cooled 250 ton chillers. Model York YTH3A2C1-CJH.
- Primary/secondary chilled water pumping arrangement: Two 7.5 HP primary pumps in series with each chiller. Two 7.5 HP secondary pumps in parallel. Variable speed drives on secondary pumps.
- Cooling tower: One cooling tower with a VFD. Cooling tower was designed for a 6° approach temperature, a 9° range, and a 68°F wet-bulb temperature. There are two cells, each with a capacity of 705 GPM at design conditions. Each cell has a 25 HP axial fan with a VFD.
- Condenser water pumps: There are six condenser water pumps, two that serve the chillers, two that pump to the heat exchanger (on the open side), and two on the closed loop side that serve auxiliary loads off of the condenser water riser. The two chiller condenser water pumps are 20 HP each, constant speed. The other two open-loop side condenser water pumps are 5 HP each, constant speed. The closed-loop side condenser water pumps are 5 HP each, variable speed driven.
- Interior zones are served by cooling-only VAV boxes. Perimeter zones are served by VAV boxes with hot-water reheat coils.
- Two natural-draft boilers provide hot water for building heating. Each boiler has an output of 1,400,000 Btu/hr. Two 5 HP variable-speed driven pumps, in a primary only arrangement, distribute hot water.
- A condenser water loop serves process loads within the building, including computer room AC units. This condenser water is piped through a heat exchanger. The heat exchanger is served by the cooling tower with two constant volume flow pumps, 5 HP each.
- The building has scheduled lighting controls for the core and occupancy sensors in the private offices.

- Supply air temperature reset control is in use. The supply pressure is operated at a fixed setpoint of 1.5”.
- The building has an Automated Logic Corporation (ALC) control system, which does not expose VAV box damper position for trending.

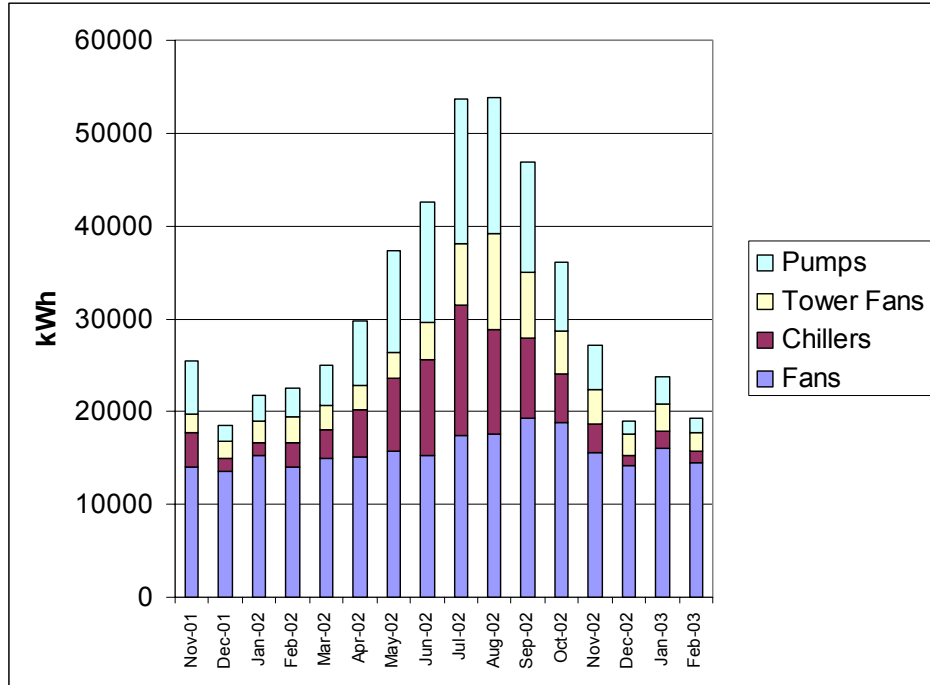

Figure 101. Site 1, Monitored HVAC Electricity End Uses

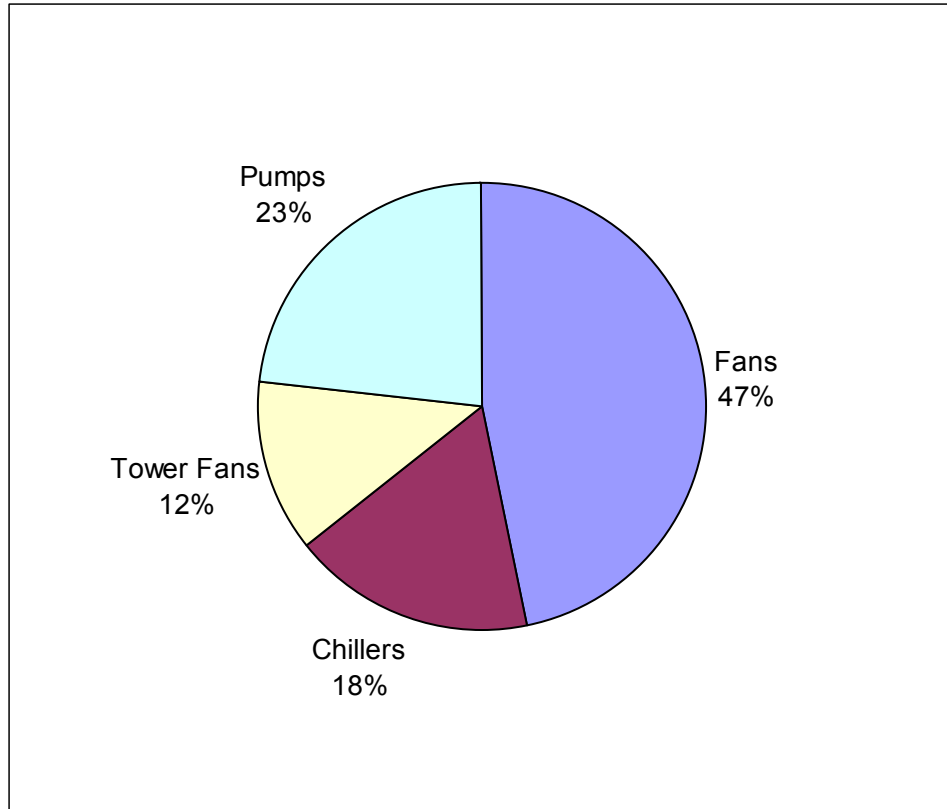

Figure 102. Site 1, Monitored HVAC Electricity End Uses

Site 2



Figure 103. Site #2 – Speculative Office Building in San Jose, CA

- Occupancy type: Private office, speculative building, with computer rooms, 100% occupied.
- Location: San Jose, California.
- Floor area: 307,000 ft².
- Number of stories: 12.
- Occupancy date: December 2000.
- Number of air handlers: Two built-up air handlers located in the mechanical penthouse that serve separate shafts. The shafts are connected on each floor via a loop duct. Each air handler has two housed centrifugal supply fans with airfoil blades, each with 100 HP motor. Each of the four supply fans is sized for 70,000 cfm at 5.0" w.c.. Each air handler also has six propeller-type vane-axial relief fans, each with 5 HP motors. All fans have variable speed drives. The relief fans are controlled in two gangs of three fans for each air handling system.
- Chilled water plant: Two 400-ton water-cooled centrifugal chillers rated at 0.54 kW/ton, model Trane CVHF0500AIH. Chillers have inlet vanes to control capacity.
- Chilled water is distributed by two constant-speed primary pumps, 25 HP each.
- Two natural-draft boilers provide hot water for building heating. Each boiler has an output of 2,400,000 Btu/hr. Two constant speed pumps, in parallel, distribute hot water. Each pump is 7.5 HP.
- Interior zones are served by cooling-only VAV boxes. Perimeter zones are served by VAV boxes with hot water reheat coils.
- Two condenser water pumps each at 40 HP serve a condenser water riser that is directly connected (i.e., no heat exchanger) to the cooling tower. The cooling tower has two cells and two VSD fans of 30 HP each. Design flow is 2,830 gpm, with a 10°F range and 8.6°F approach. In addition, there is an auxiliary condenser water system with a separate cooling tower for computer room air conditioners served by two pumps of 15 HP each.
- The HVAC control system is by Siemens (Apogee).
- The building has lighting controls.
- Supply air temperature reset control is in use. Supply air static pressure is fixed.



Figure 104. Relief Fan (one of six per penthouse)



Figure 105. Relief Fan Discharge

Site 3

Figure 106. Site #3 – Southwest Corner View (Main Entrance)



Figure 107. Site #3 – Northwest View

- Occupancy type: Public office with computer rooms on 8th floor and a gym.
- Location: Sacramento, California.

- Floor area: 955,000 ft²
- Number of stories: 25.
- Occupancy date: October 2000.
- Number of air handlers: 58 packaged VAV units with centrifugal supply and exhaust fans, as well as variable speed drives. The supply fans are plenum type installed in a packaged air-handling unit. The exhaust fans are tubular centrifugal. Chilled water cooling coil (draw-through). Hot water pre-heat coil. Typical arrangement is two air handlers per floor connected through a loop duct.
- Chilled water plant: Three Carrier electric centrifugal chillers with variable speed compressor, 300 tons at 0.55 kW/ton, 800 and 1,200 tons at 0.50 kW/ton. Primary/secondary pumping configuration with three constant speed primary pumps totaling 110 HP, and three variable-speed secondary pumps totaling 150 HP.
- Cooling tower: Four cells, each with variable speed axial fan, total 200 HP fan motor and 2,875 tons heat rejection capacity. Three constant speed condenser water pumps: 30 HP, 75 HP, and 100 HP.
- Two natural draft gas boilers that produce heating hot water (2,400 and 3,000 MBH).
- Air handlers: The 16th floor was the focus of monitoring for this research. LBNL recorded data from both 16 and 17 floors each 36,000 ft², with 16 as the control floor (i.e., no sealing or adding holes to the ducts). There are two air handlers on 16th floor located in the northwest and northeast corners. Both are connected to a common supply air duct loop. One branch of the loop runs between the two air handlers along the north side. The other branch runs between the two AHUs and loops around the east, south, and west sides.
- Zone VAV boxes: There are 39 VAV boxes on the 16th floor. Fourteen are parallel-fan powered boxes with electric reheat coils that serve perimeter zones; the remaining 25 boxes are cooling-only VAV boxes serving interior zones.
- The building has a Johnson Metasys control system.
- The supply fans on the 16th floor are controlled to a fixed 1" w.c. setpoint. It is possible to reset the supply pressure by demand.

Data collected from interior zones provide examples of the range and diversity of zone cooling loads. At Site 3, the data show that the most typical load is in the range of 1.0 to 1.5 W/ft² and is seldom higher than 2.0 W/ft². Figure 108 shows the distribution for a sample of three interior zones.

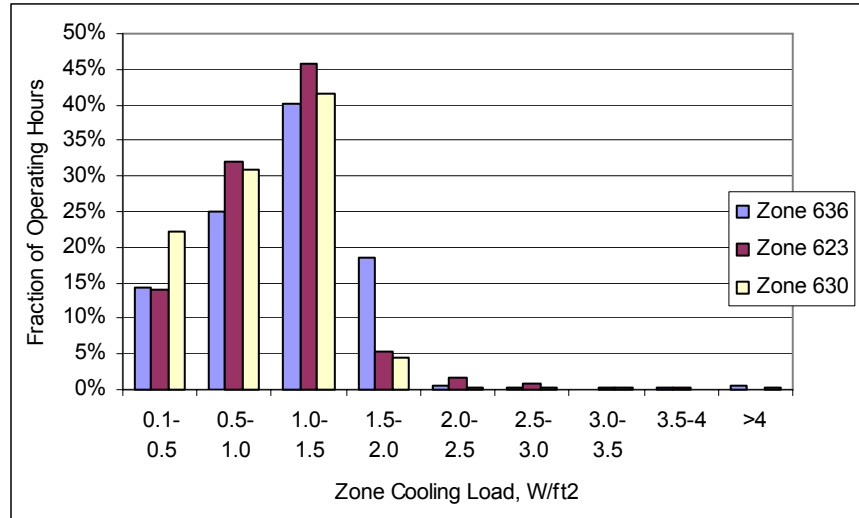

Figure 108 – Monitored Cooling Loads for a Sample of Three Interior Zones, Site 3 (Office)

Site 4



View of South Face



View of North Face

Figure 109. Site #4 – Federal Courthouse at Sacramento

- Occupancy type: Federal Courthouse.

- Location: Sacramento, California.
- Floor area: 570,000 ft².
- Number of stories: 16 (7th floor monitored by this research).
- Occupancy date: January 1999.
- Number of air handlers: 30. Typical floor has two VAV air handlers with one serving the core areas with courtrooms and the other serving perimeter areas that include public and office areas. The majority of the air handlers are designed for 20,000 cfm airflow and have 20 HP supply fans (centrifugal airfoil type) and 7.5 HP return fans (tubular centrifugal in-line type). The return system is ducted. Chilled water and hot water coils have two-way valves and include water flow sensors and supply and return temperature sensors that allow coil cooling/heating load calculation. Each air handler also has airflow measurement stations on the supply and return air. Minimum outdoor airflow is specified as 3,200 Ccfm per air-handler. The systems were designed with a CO₂ sensor on the return ductwork of the interior unit. The control sequence for this sensor was never uncovered.
- Chilled water plant: Three Trane centrifugal chillers, two 675 tons at 0.545 kW/ton and one 350 tons at 0.535 kW/ton. The smaller chiller has variable speed compressor controls. Primary/secondary pump configuration with three constant speed primary pumps totaling 50 HP and three variable-speed secondary pumps totaling 125 HP.
- Cooling tower: Three cells, each with variable speed axial fan, total 180 HP fan motor and 2,500 tons heat rejection capacity. Designed to produce 80°F water at 73°F outdoor wetbulb temperature. Three constant speed condenser water pumps: 60 HP, 60 HP, and 30 HP.
- Controls: Johnson Metasys control system with extensive monitoring. Each floor has CHW and heating HW btuh meters both at the take-off from the risers and for each coil on the air-handling units. The base building also has supply and return airflow for each air handler. The system also monitors chiller cooling load and electric demand.
- Perimeter zones are served by VAV boxes with hot-water reheat coils. Core zones, including courtrooms, have VAV boxes without reheat.
- Hot water plant: Two forced draft boilers of 10,420 kBtu/hr capacity each. Primary/secondary hot water pumping configuration.
- Supply air pressure is fixed but reset by demand is possible.

- This site has floor-by-floor air-handling systems with separate units for the interior and perimeter. The 7th floor was chosen for monitoring because it was both representative of the building, but logistically easy to work with. This floor houses the bankruptcy court and hearing rooms. The two hearing rooms vary from completely empty to fully occupied throughout the day. Three CO₂ sensors were installed, one in each of the two hearing rooms and one in the courtrooms. The CO₂ sensors were wired to the closest VAV box and trended through the DDC controls system.

Site 5

Figure 110. Site #5 – Office Building in Oakland

- Occupancy type: Municipal office, retail, computer room.
- Location: Oakland, California.
- Floor area: 173,000 ft².

- Number of stories: Eight.
- Occupancy date: Summer 1998.
- Number of air handlers: One. A central VAV system consists of two supply and two return fans that serve floors two through eight (floor one is retail and is served by water source heat pumps connected to a separate condenser water system with a fluid cooler).
- Chilled water plant: The office building shares a chilled water plant with the adjacent building (which was not studied) that consists of two 500-ton water-cooled centrifugal chillers. Chilled water is distributed through a primary/secondary pump configuration with a separate set of secondary pumps for each building. An air-cooled chiller serves three computer room AC units.
- The building has its own hot water boiler.
- Perimeter zones are served by standard VAV boxes with hot water reheat coils. Core zones have standard VAV boxes without reheat.
- The building has lighting controls.
- The control system is by Staeffa.

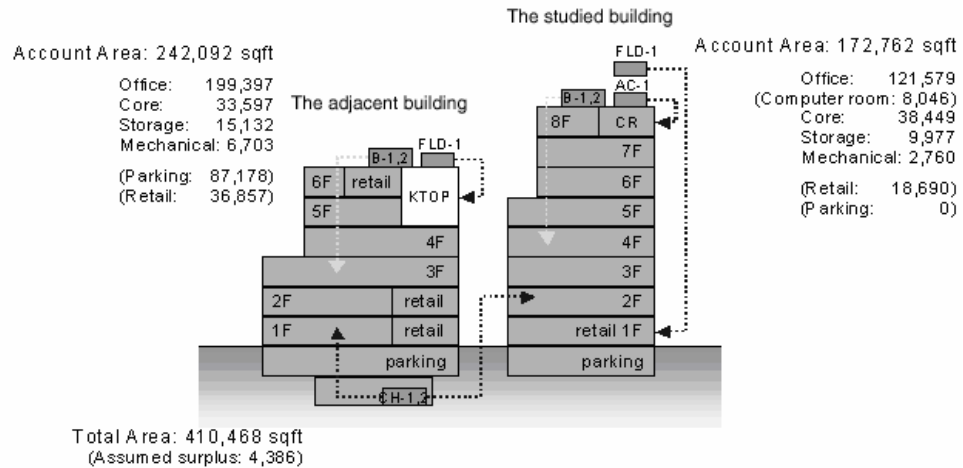

Figure 111. Buildings Summary (Source: Naoya Motegi, LBNL)

Appendix 2 – Measured Fan Performance

Energy Benchmark Data

Energy end use analysis can provide insights into what systems and equipment provide the most potential for energy savings. Table 26 lists office building data from several surveys and from monitoring of specific sites. In looking at this table, it is important to note that a number of factors influence the values like climate, hours of operation, energy sources for heating and cooling, age of the building, building occupancy, and others. This is particularly true for databases like CEUS, NRNC, and others. Annual electricity consumption varies from 10.0 to 21.1 kWh/ft². Of that total, HVAC electricity accounts for 15% to 51%, and fans use 25% to 61% of the HVAC electricity. Annual fan energy consumption ranges from 1.5 to 4.0 kWh/ft². In the three monitored buildings included in Table 26, fans consumed between 47% to 61% of the total HVAC electricity. The design of airside systems clearly deserves attention not only because fans are a significant end use but also because, as these guidelines attempt to show, significant cost effective savings are possible.

Table 26. Office Building Energy End Use Consumption from Several Sources

	CEUS, 1997	CEUS, 1999	NRNC, 1999	Bldgs Energy Data book, 2002	Site 1, 2002	Site 2, 2/02 - 1/03	Site 5, 8/99- 7/00
Fans (kWh/ft ² /yr)	4.0	1.5	2.4	1.5	1.8	1.8	1.6
Cooling (kWh/ft ² /yr)	3.2	4.5	2.9	2.7	2.1	1.1	1.3
Heating (kWh/ft ² /yr)	n.a.	n.a.	0.4	n.a.	n.a.	n.a.	n.a.
Lighting (kWh/ft ² /yr)	4.6	3.7	4.0	8.2	n.a.*	n.a.*	3.6
Misc. (kWh/ft ² /yr)	2.4	3.1	5.6	5.9	17.2	16.6	3.5
Total Electricity (kWh/ft ² /yr)	14.2	12.7	15.3	18.4	21.1	19.5	10.0
Heating Gas (kBtu/ft ² /yr)	22.4	20.6	n.a.	24.3	31.8	82.5	18.1
HVAC % of Total Electricity	51%	47%	37%	23%	19%	15%	30%
Fans % of HVAC Electricity	56%	25%	45%	36%	47%	61%	56%

* Lighting energy not monitored separately from other misc loads at sites 1 and 2.

Sources:

CEUS 1997. Commercial End-Use Survey, Pacific Gas & Electric Company.

CEUS 1999. Commercial End-Use Survey, Pacific Gas & Electric Company.

NRNC, 1999. Nonresidential New Construction Baseline Study, prepared by RLW Analytics for Southern California Edison.

Buildings Energy Data book, 2002. U.S. Department of Energy, Office of Energy Efficiency and Renewable Energy.

Site 1. Commercial office building, San Jose, CA. See Appendix for details.

Site 2. Commercial office building, San Jose, CA. See Appendix for details.

Site 5. Public office building, Oakland, CA. See Appendix for details.

Fans also contribute a significant amount to a building's peak electricity demand. Figure 112 shows the fan-only peak day electric demand for three monitored sites, which reaches between 0.5 and 1.0 W/ft². Monitoring also shows that fans account for about 15% of the peak day demand at Site 1 and 12% at Site 2, corresponding to 0.60 W/ft² and 0.75 W/ft², respectively.

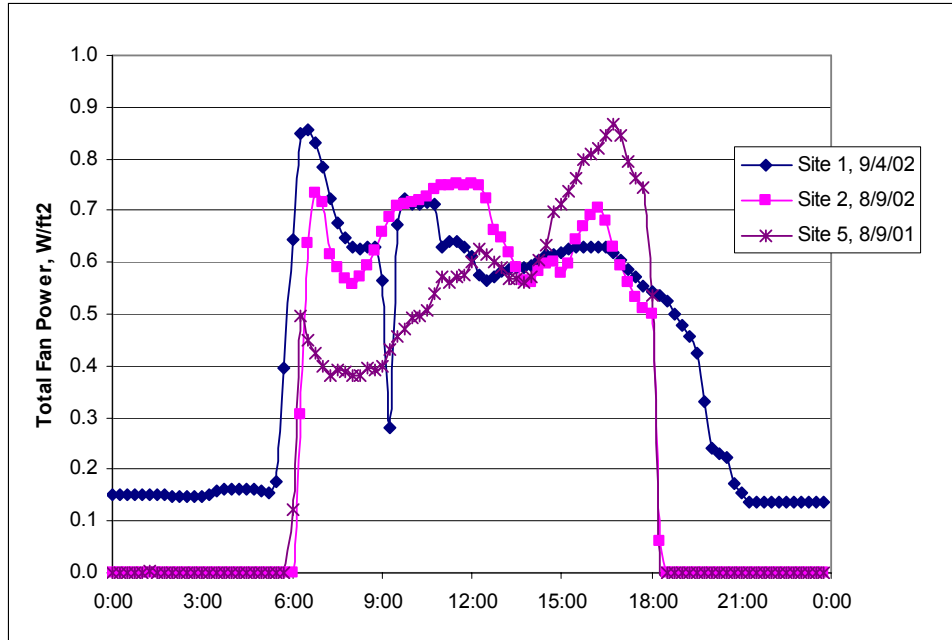

Figure 112. Peak Day Fan Electric Demand, Three Sites

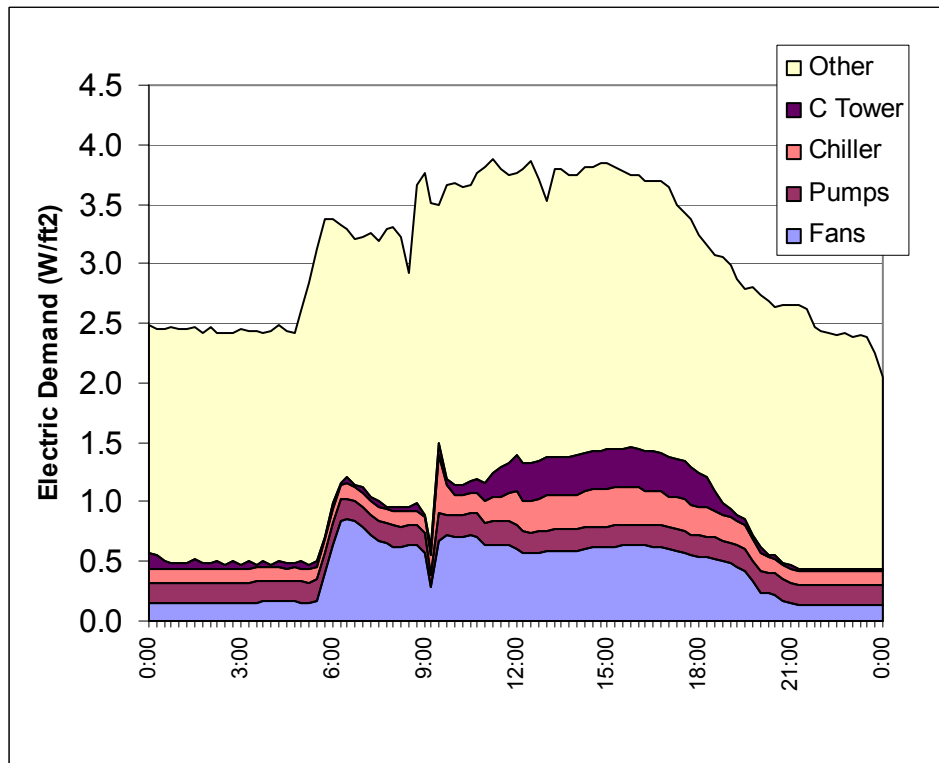

Figure 113. Peak Day Electric Demand, Site 1, 9/3/2002 (Cumulative Graph; Total Peak is 3.9 W/ft²)

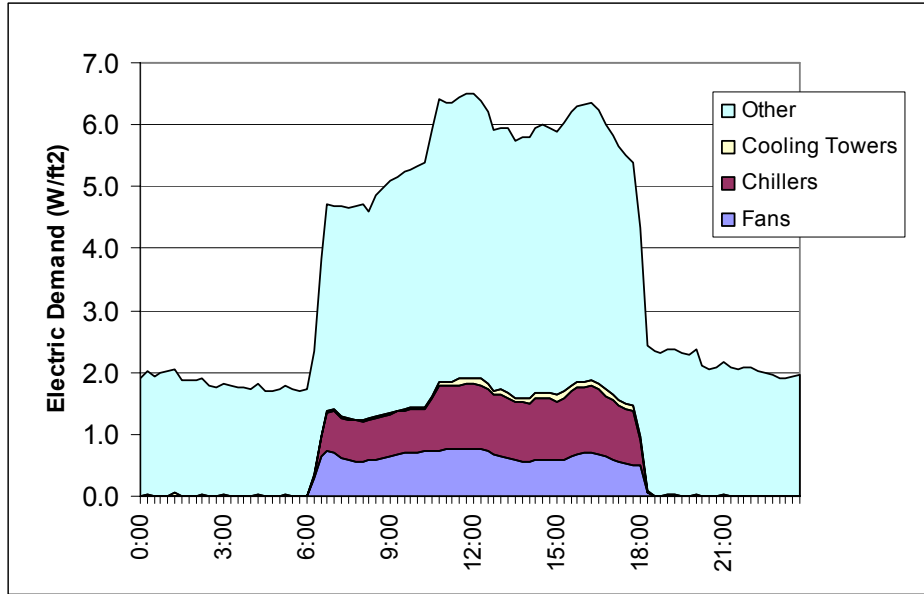

Figure 114. Peak Day Electric Demand, Site 2, 8/9/2002 (Cumulative Graph; Total Peak is 6.4 W/ft²)

Fans vs. Chillers

Which is the bigger energy consumer? At two monitored sites, the fans account for more electricity consumption than the chiller.

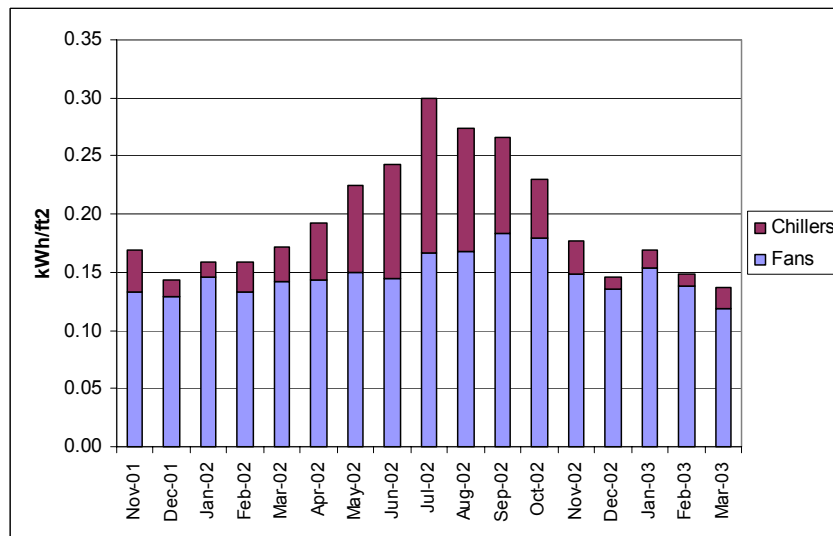

Figure 115. Comparison of Fan and Chiller Energy at Site 1 (Cumulative Graph, e.g. Combined Total is 0.30 kWh/ft²-yr in July)

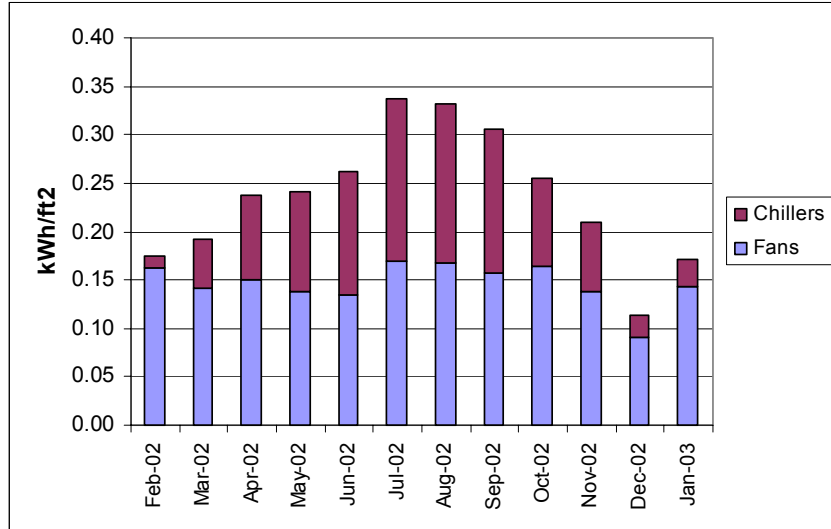

Figure 116. Comparison of Fan and Chiller Energy at Site 2 (Cumulative Graph, e.g. Combined Total is 0.34 kWh/ft²-yr in July)

Appendix 3 – Airflow in the Real World

Research shows, as should be expected, that VAV systems seldom, if ever, reach their design airflow, usually getting by with significantly less. This fact is illustrated in the examples below at the both the zone level and the air handler level. In addition, the zone level data shows that many zones spend a majority of their time at minimum flow. In these cases, it's likely that even lower airflow would have provided comfort while also saving fan and reheat energy.

Based on the real world dynamics of a VAV system, the designer should pay special attention to system performance at typical conditions (where the system spends the most hours) as well as at the minimum load conditions. The Terminal Unit section provides relevant guidance on VAV box selection and control. The Fan Sizing and Control section addresses design at the air handler level.

Figure 117 through Figure 122 illustrate several examples of zone airflow variations. Similar data for total air handler airflow are shown in Figure 123 through Figure 126. Since airflow requirements depend on many factors, these results should be considered illustrations of VAV system dynamics and not be considered directly comparable to conditions in other buildings.

Interior Zone Airflow

Interior zones are affected very little by building envelope cooling or heating loads, and Figure 117 and Figure 118 show that airflow is nearly constant for a sample of three interior zones at Site 3, an office building.

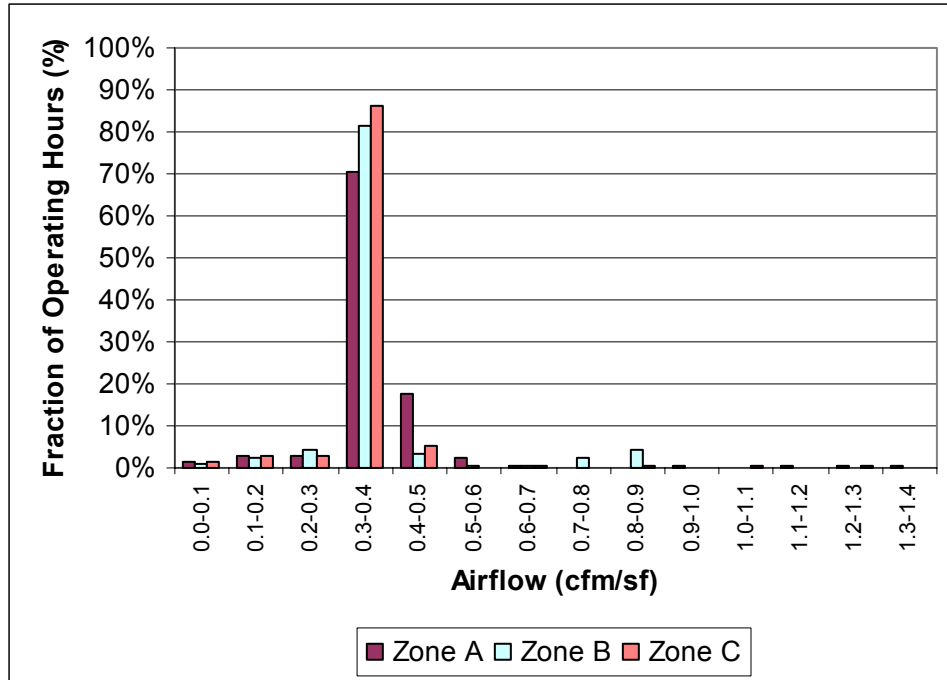

Figure 117. Site 3, Sample of Interior Zones, Warm Period (8/8/02 - 9/7/02)

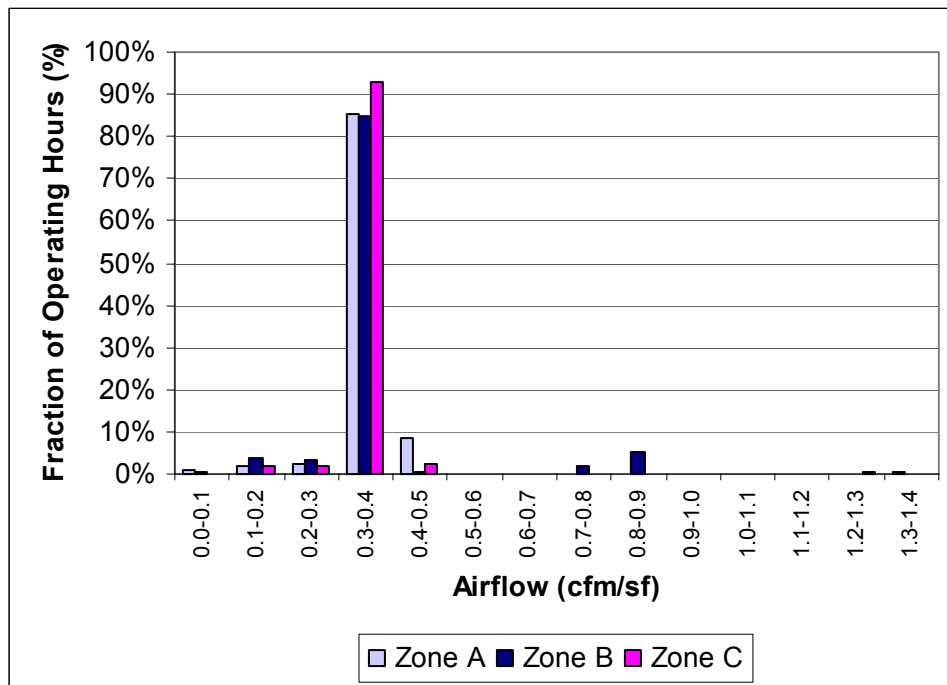

Figure 118. Site 3, Sample of Interior Zones, Cool Period (12/12/02-1/11/03)

While some minor variation exists, airflow falls between 0.3 and 0.4 cfm/ft² for 70% to 90% of operating hours during both warm and cool times of the year. Figure 119 shows more variation in interior zone airflow in a Site 4, a courthouse.

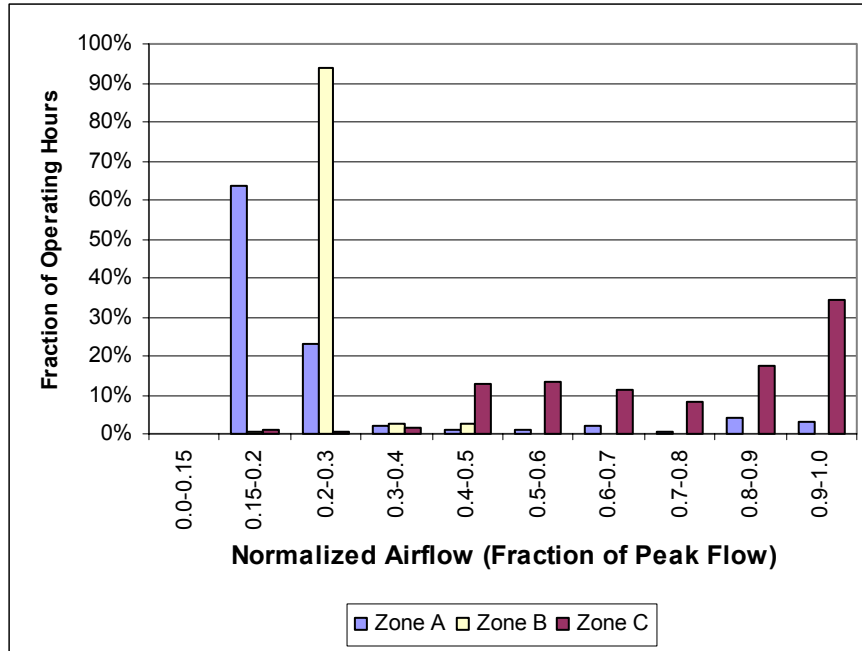

Figure 119. Site 4, Sample of Interior Zones (10/18/02-2/24/03)

Perimeter Zone Airflow

Airflow variation can be more significant in perimeter zones than in interior spaces. The following examples show this variation, but they also reveal that airflow is at low level (probably the minimum flow set point entered in the control system) for a large part of the time. As discussed earlier in this guideline, these minimum flow set points lead to lost savings opportunities. See the chapter on Terminal Units.

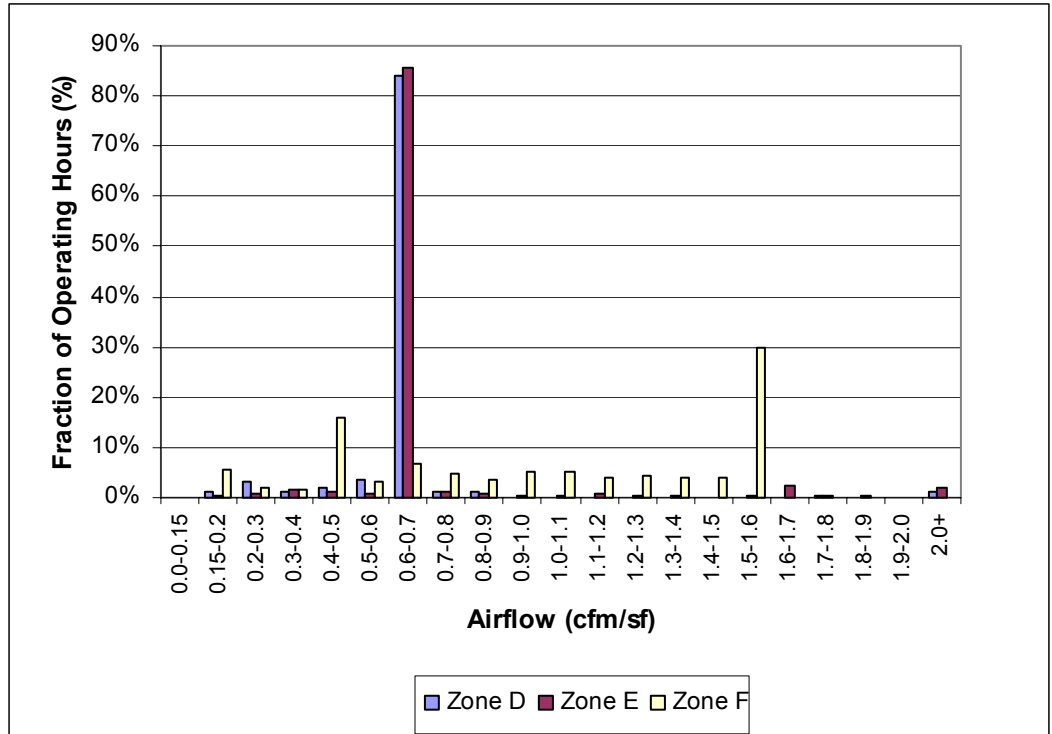

Figure 120. Site 3, Sample of Perimeter Zones, Warm Period (8/8/02 - 9/7/02)

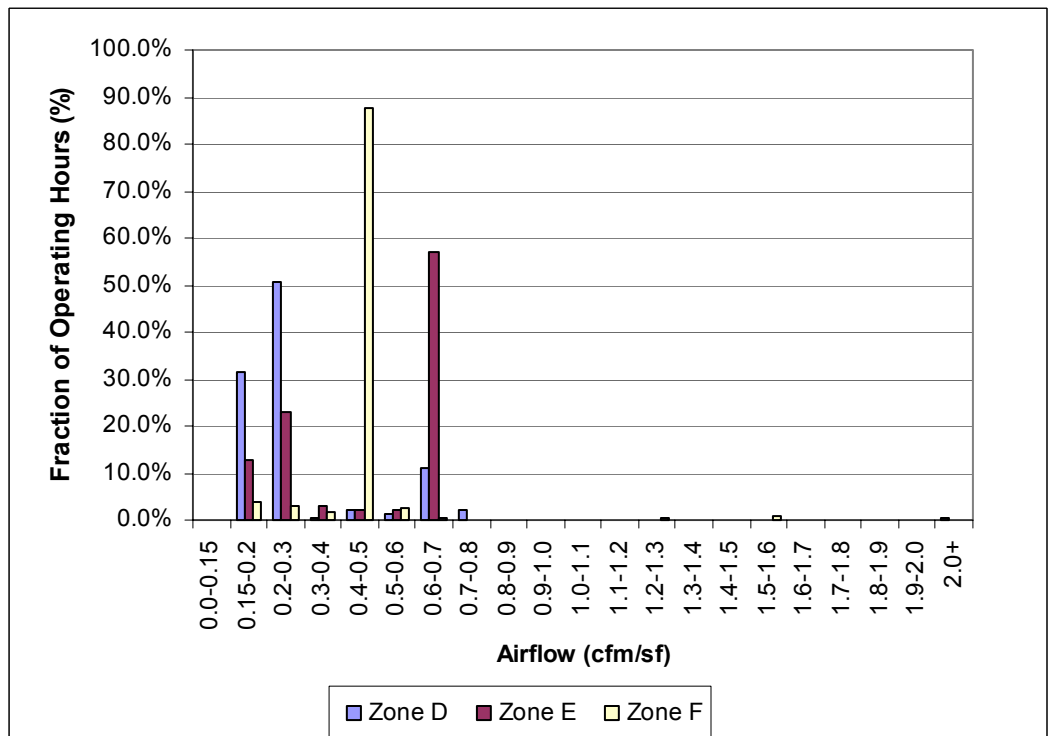

Figure 121. Site 3, Sample of Perimeter Zones, Cool Period (12/12/02-1/11/03)

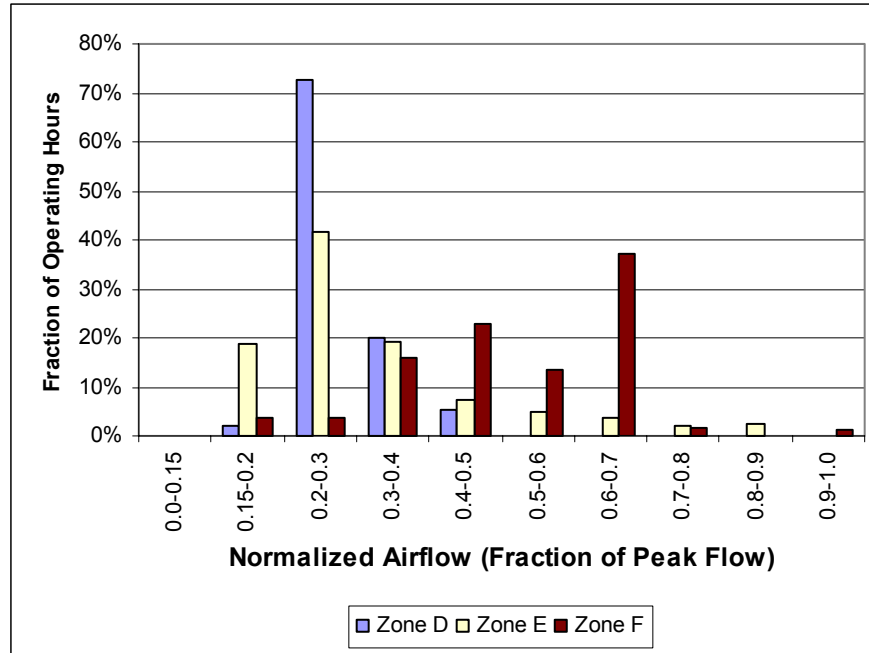

Figure 122. Site 4, Sample of Perimeter Zones (10/18/02-2/24/03)

System Level Airflow

Diversity of airflow at the zone level leads, of course, to diversity at the system level. Monitored data from four sites presented in Figure 123 through Figure 126 provide a strong argument for designing the system to work optimally at flows less than that predicted by traditional design methods.

Figure 123 shows that Site 1, which was designed to supply 1.4 cfm/ft², never exceeds 0.8 cfm/ft² and usually operates between 0.4 and 0.6 cfm/ft² during the day. This facility operates 24 hours per day, which accounts for the large fraction of hours in the 0.2 to 0.3 cfm/ft² range.

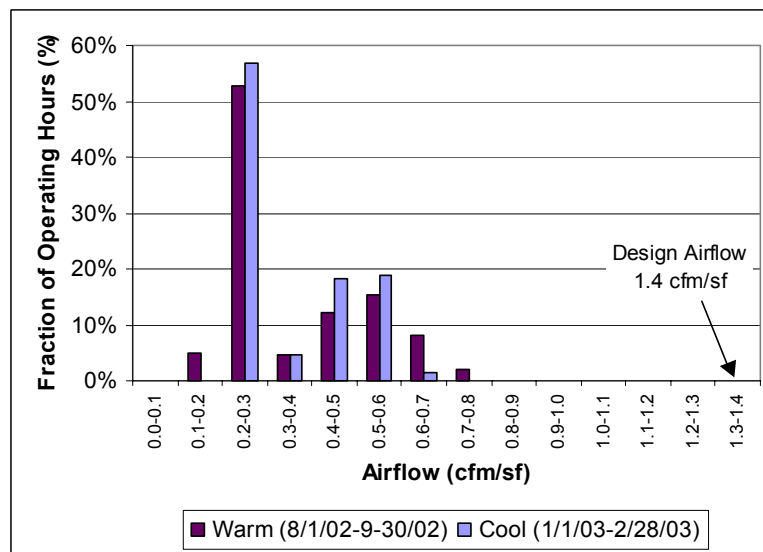

Figure 123. Total System Airflow, Site 1

At Site 2, illustrated in Figure 124, a clear seasonal variation exists in system airflow, which is typically 0.6 to 0.8 cfm/ft² during warm weather and 0.5 to 0.6 cfm/ft² in cool conditions. This building is located nearby Site 1 but has a significantly larger window area.

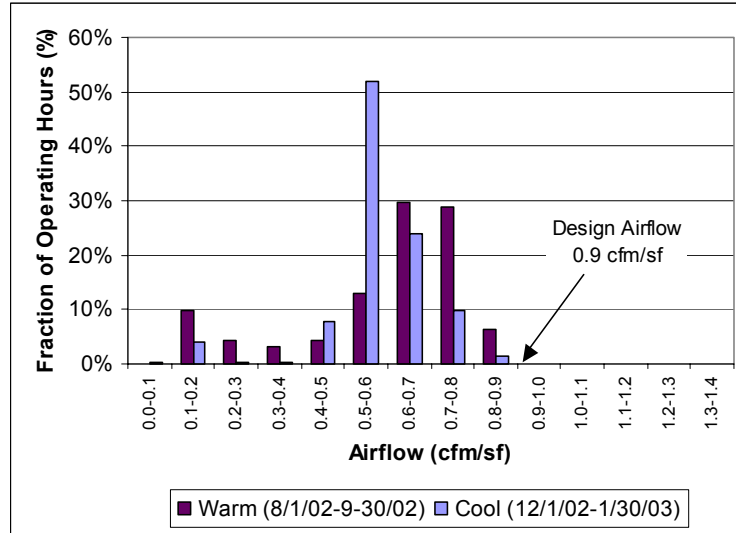

Figure 124. Total System Airflow, Site 2

Both Sites 3 (Figure 125) and 4 (Figure 126) experience seasonal airflow variation at the air handler level, with the majority of operating hours occurring at or below one-half of the design airflow.

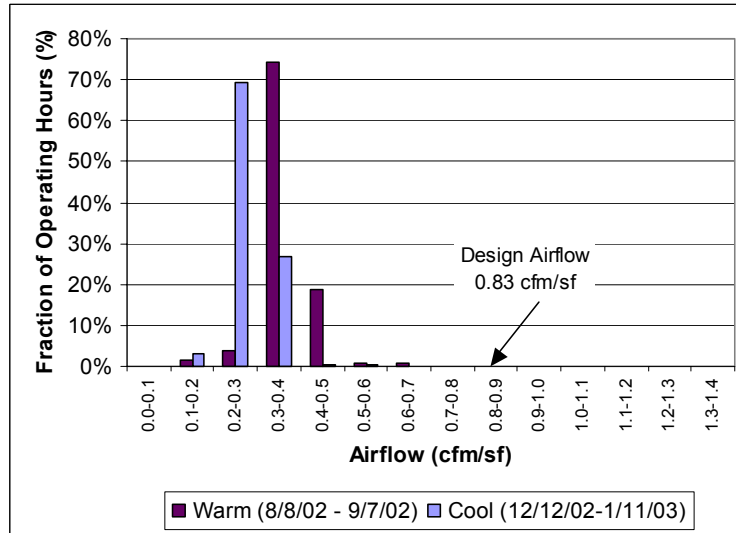

Figure 125. Total System Airflow, Site 3

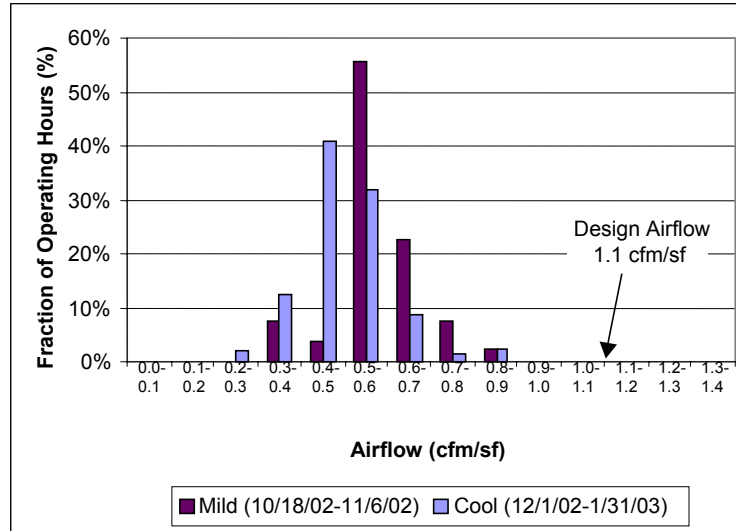

Figure 126. Total System Airflow, Site 4

Appendix 4 – Cooling Loads in the Real World

For a different perspective on zone load profiles, this appendix discusses five examples of air handler cooling output, including include both interior and perimeter zones. Load profile are represented here as the number of hours that loads fall into different ranges.

At Sites 1 and 3, the cooling delivered by the air handler rarely exceeds an average of 2.0 W/ft² and is often less than 1.0 W/ft². The other two buildings show higher loads, with the majority of hours at Sites 2 and 4 falling between 1.5 and 3.0 W/ft².

Some of the sites show much more seasonal variation than others. Site 1 shows only slightly higher loads in the warmer months, while Sites 2 and 3 have loads of about 1 W/ft² higher in the warm periods. (Warm weather data is not available for Site 4.)

With the exception of Site 2, none of these buildings require levels close to their peak air handler cooling capacity.

These results can be useful in several ways:

- Providing some insight in the range of operation typically required of an HVAC system.
- Serving as a benchmark for evaluating simulation results.
- Serving as a reminder that typical load calculations and sizing decisions are conservative.

Of course, judgment needs to used when applying monitored data from existing buildings. Loads today may be lower than in the past. Advances in lighting technologies, glazing performance, and office equipment have lead to decreases in loads over recent years. It is also useful to know something about the controls and setpoints in the existing buildings. Minimum zone airflow setpoints are especially important information because they affect the air flow profile at both the zone level and the air handler level.

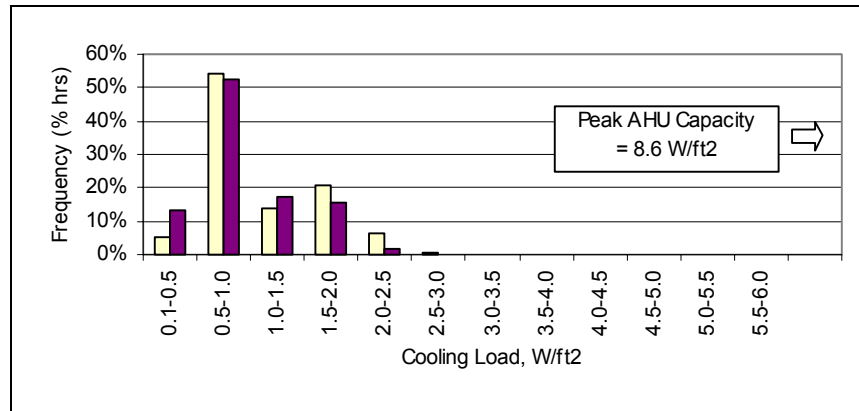

Figure 127. Site 1
 (Dark bar includes Jan-May 2002 and Nov-Dec 2002, light bar covers Jun-Oct 2002)

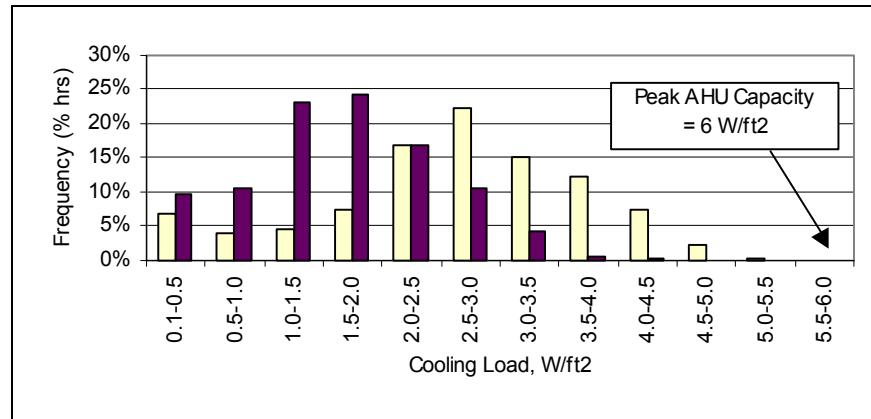

Figure 128. Site 2
 (Light bar includes Jun-Oct 2002, dark bar covers Nov 2002 – Jan 2003)

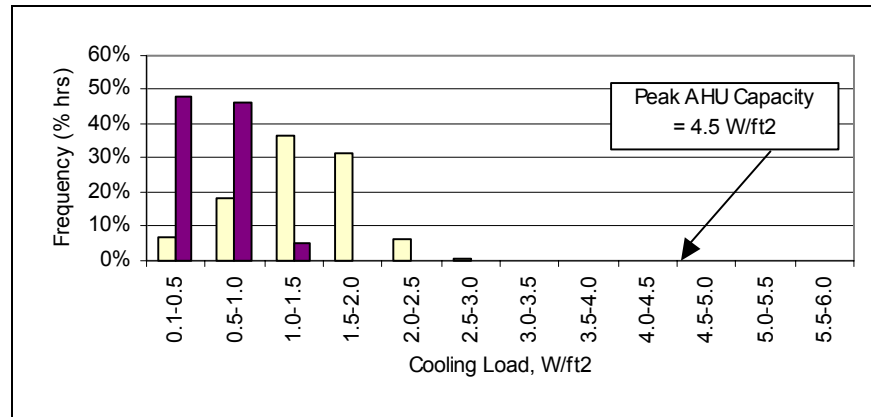

Figure 129. Site 3
 (Light bar includes Aug-Oct 2002, dark bar covers Nov 2002 – Jan 2003)

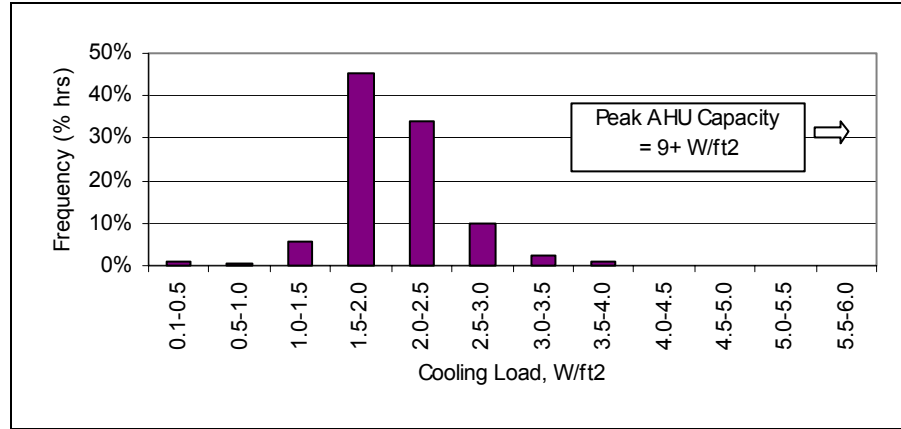

Figure 130. Site 4
(Dark bar includes Nov. 25, 2002 - Feb. 24, 2003)

Figure 131 is similar to the previous graph except that it includes cooling delivered from an air handler to a group of only interior zones.³³ An important thing to note here is how few hours are spent at peak load compared to typical load. (This air handler is designed to deliver up to 6 W/ft² of cooling to these zones).

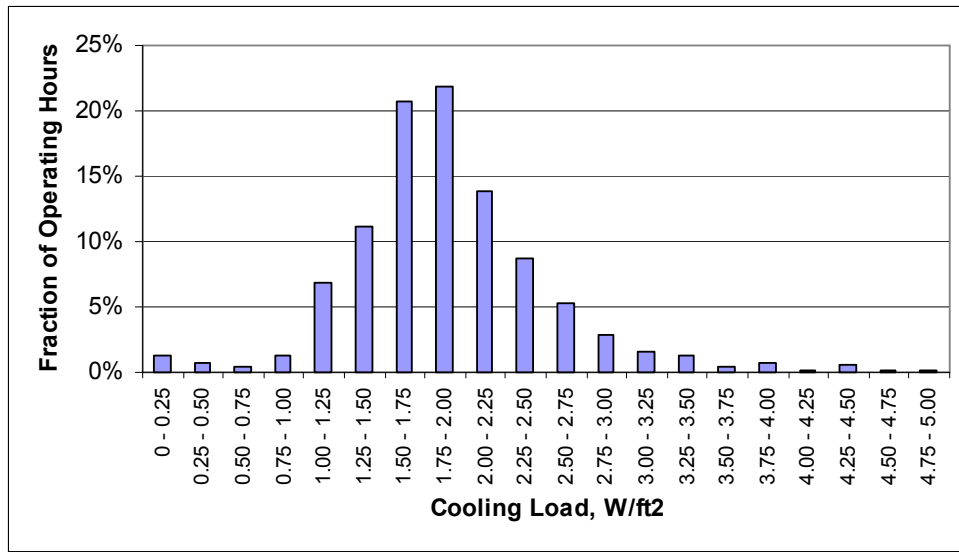

Figure 131. Monitored Sensible Cooling Load for an Air Handler Serving 19 Interior Zones, Site 4

³³ Since these zones have no connection to the outdoors, these data represent the sum of loads from lights, plug loads and occupants.

Appendix 5 – DOE-2 Fan Curves

Created by Jeff Stein 5-5-03

These fan curves were developed using the Characteristic System Curve Fan Model developed by Stein and Hydeman.

Curves include part load performance of the fan, belt, motor, and VSD

This is based on a plenum airfoil fan on a system curve through 0.7"

"Typical VSD Fan" = CURVE-FIT

TYPE = CUBIC

INPUT-TYPE = COEFFICIENTS

OUTPUT-MIN = 0

OUTPUT-MAX = 1

COEFFICIENTS = (0.047182815, 0.130541742, -0.117286942, 0.940313747)

..

This is based on a plenum airfoil fan on a system curve through 0"

"Perfect SP Reset VSD Fan" = CURVE-FIT

TYPE = CUBIC

INPUT-TYPE = COEFFICIENTS

OUTPUT-MIN = 0

OUTPUT-MAX = 1

COEFFICIENTS = (0.027827882, 0.026583195, -0.0870687, 1.03091975)

..

This is based on a plenum airfoil fan on a system curve through 0.5"

"Good SP Reset VSD Fan" = CURVE-FIT

TYPE = CUBIC

INPUT-TYPE = COEFFICIENTS

OUTPUT-MIN = 0

OUTPUT-MAX = 1

COEFFICIENTS = (0.040759894, 0.08804497, -0.07292612, 0.943739823)

..

This is based on a plenum airfoil fan on a system curve through 1.5"

"No SP Reset VSD Fan" = CURVE-FIT

TYPE = CUBIC

INPUT-TYPE = COEFFICIENTS

OUTPUT-MIN = 0

OUTPUT-MAX = 1

COEFFICIENTS = (0.070428852, 0.385330201, -0.460864118,
1.00920344)

..

Plenum 0" (0.027827882, 0.026583195, -0.0870687, 1.03091975)

Plenum 0.3" (0.034171263, 0.059448041, -0.061049511, 0.966140782)

Plenum 0.4" (0.037442571, 0.072000619, -0.062564426, 0.952238103)

Plenum 0.5" (0.040759894, 0.08804497, -0.07292612, 0.943739823)

Plenum 0.6" (0.044034586, 0.107518462, -0.091288825, 0.939910504)

Plenum 0.7" (0.047182815, 0.130541742, -0.117286942, 0.940313747)

Plenum 0.8" (0.050254136, 0.156227953, -0.148857337, 0.943697119)

Plenum 1.0" (0.056118534, 0.214726686, -0.226093052, 0.957646288)

Plenum 1.5" (0.070428852, 0.385330201, -0.460864118, 1.00920344)

Appendix 6 – Simulation Model Description

This appendix provides a brief description of the simulation model used to evaluate several of the guideline recommendations, including the following:

- Comparison of “Standard” to “Best Practice” design performance (Introduction).
- VAV box sizing criteria (Terminal Units).
- Optimal supply air temperature reset control methods (Supply Air Temperature Control).

More details of the assumptions and results are described in Analysis Report that documents guidelines-related research.

Assumptions

Building Envelope

1. Five story, 50,000 ft² square building. Each floor is 100 feet by 100 feet. 5 zones per floor, total 25 zones. Floor to floor height is 13 feet, plenum height is 4 feet.
2. Continuous strip of glazing, double pane, low-e glass (DOE-2 code 2637, similar to Viracon VE1-2M. SC = 0.43, Uvalue = 0.31, Tvis = 0.44). 40% WWR (window height is 5.2 feet).
3. 12-foot deep perimeter zones.
4. Exterior wall construction U-value is 0.088 Btu/hr-ft²-°F.
5. No skylights, no daylighting controls.

Climate

California Zone 3 (San Francisco Bay Area) and Zone 12 (Sacramento)

Internal Loads

1. Lighting power density: 1.5 W/ft²
2. Equipment power density: 2.0 W/ft²
3. Occupancy density: 100 ft²/ person

Load Schedules

In order to capture the effect of reheat at low load, we used schedules that went up and down over the course of each day. We used three “high,” three “medium,” and three “low” schedules. Each zone was randomly assigned one of the nine schedules. The schedules were the same for all weekdays of the

year. For simplicity, we used the same schedule for lights, people, and equipment.

Fan Schedule

5 am – 7 pm, 14 hours of operation.

Thermostat setpoints

72°F cooling, 70°F heating.

Design Airflow

Loads calculations were run in Trace. For each climate zone, we determined a normalized airflow (CFM/ft²) for each orientation. These airflows were then multiplied by the zone areas used in DOE-2. DOE-2 Keyword: ASSIGNED-CFM

Table 27. Basecase Design Air Flows

Orientation	Design Flow Rate (CFM/ft ²)	
	CZ03	CZ12
North Zones	1.06	1.23
South Zones	2.21	2.28
East Zones	1.96	2.01
West Zones	2.19	2.36
Interior Zones	0.77	0.77

Zone Properties

1. OA calculated based on 15 cfm/person.
2. THERMOSTAT-TYPE: Reverse Action. For VAV systems, this Thermostat Type behaves like a dual maximum thermostat, it allows the airflow rate to rise above the minimum design heating airflow rate (i.e., the Minimum Flow Ratio).
3. THROTTLING-RANGE: 0.5°F
4. MIN-FLOW-RATIO: DOE-2 takes the maximum of MIN-FLOW-RATIO and MIN-CFM/SQFT to determine the minimum airflow.
 - MIN-FLOW-RATIO: this is the box turndown. It varies from 8.4% to 13%.
 - MIN-CFM/SQFT is set to 0.15 cfm/ ft² (for ventilation).

System Properties

1. PIU system with standard VAV terminals. One air handler for the building.
2. Supply Fan efficiency: 60% (this includes motor, belt and drive efficiency). Note that this works more for FC and Plenum.
3. FAN-CONTROL: EIR-FPLR. (This references the following curve).
4. Fan EIRFPLR curve: AnyFanWithVSD (DOE2 default curve for VSD fan).

5. MIN-FAN-RATIO: 30%. This basically means that fan energy is fairly constant below about 30% flow, which appears to be reasonably accurate from our fan modeling.
6. SUPPLY-STATIC: 3.2 + “BTP.”: BTP is the Box Total Pressure. It varies, depending on the parametric run.
7. Motor efficiency: 100% (Motor and drive efficiency is modeled in the fan curve and peak efficiency).
8. Coil and fan capacity: A TRACE load calculation determines these parameters.
9. MIN-SUPPLY-T: 55
10. COOL-CONTROL: CONSTANT
11. Drybulb economizer: Use fixed dry-bulb with Title 24 High Limits of 75°F.
12. No return fan.
13. REHEAT-DELTA-T: 43°F (i.e., the highest allowable diffuser air temperature).

Plant Properties

1. Water-cooled chilled water plant – default efficiencies.
2. Default HW boiler.

Utility Rates

1. Electricity rate: PG&E E-20s.
2. Gas rate: PG&E GNR1.

DOE2 Version

eQuest version 3.21 build 1778 was used to perform these simulation runs. DOE-2.2-41m is the calculation engine.

Results

This section provides a brief summary of simulation results related to guideline recommendations. More details are included in the Analysis Report.

Standard Practice vs. Best Practice Results

Table 28 describes the simulation assumptions used to compare standard and best practice. From the perspective of energy performance, the two most significant differences are the fan curve that approximates the impact of supply air pressure controls and the VAV box minimum airflow fraction. Both of these measures lead to reductions in fan energy, and the minimum flow fraction also saves cooling and reheat energy. The end-use energy results are listed in Table 29 for the San Francisco and Sacramento climates.

Table 28. Airside Control Strategies for Simulation of Standard Practice and Best Practice

Item	Standard Practice	Best Practice
Fan curve	Standard VSD (DOE-2 default) without pressure reset	VSD with perfect pressure reset, which reduces fan power at partial flow compared to a standard VSD
VAV box minimum airflow fraction	30%	10% or 0.15 cfm/ft ² , whichever is greater.
Thermostat type	Proportional, which means that airflow is fixed at minimum fraction in heating mode	Reverse acting, which means that airflow can increase in heating mode. This allows a lower minimum without risk of airflow being too low to provide enough heating.
Supply air temperature reset	55°F to 60°F based on outdoor air temperature	Reset in the range between 55°F and 65°F based on warmest zone (temperature first)

Table 29. Simulation Results for Comparison of Standard Practice and Best Practice

	Lighting	Equipment	Cooling	Heat Rejection	Pumps	Fans	Total	Heating
	kWh	kWh	kWh	kWh	kWh	kWh	kWh	therms
San Francisco								
Standard Practice	76,715	102,286	79,773	915	30,834	33,231	323,755	4,560
Best Practice	76,706	102,282	63,871	770	24,788	12,613	281,111	2,374
Savings	0%	0%	20%	16%	20%	62%	13%	48%
Sacramento								
Standard Practice	76,715	102,286	99,370	1,574	30,844	38,158	348,947	5,288
Best Practice	76,706	102,282	89,780	1,424	29,686	18,432	318,374	3,479
Savings	0%	0%	10%	10%	4%	52%	9%	34%

The fan performance curves used in the comparison of standard and best practice are illustrated in Figure 132.

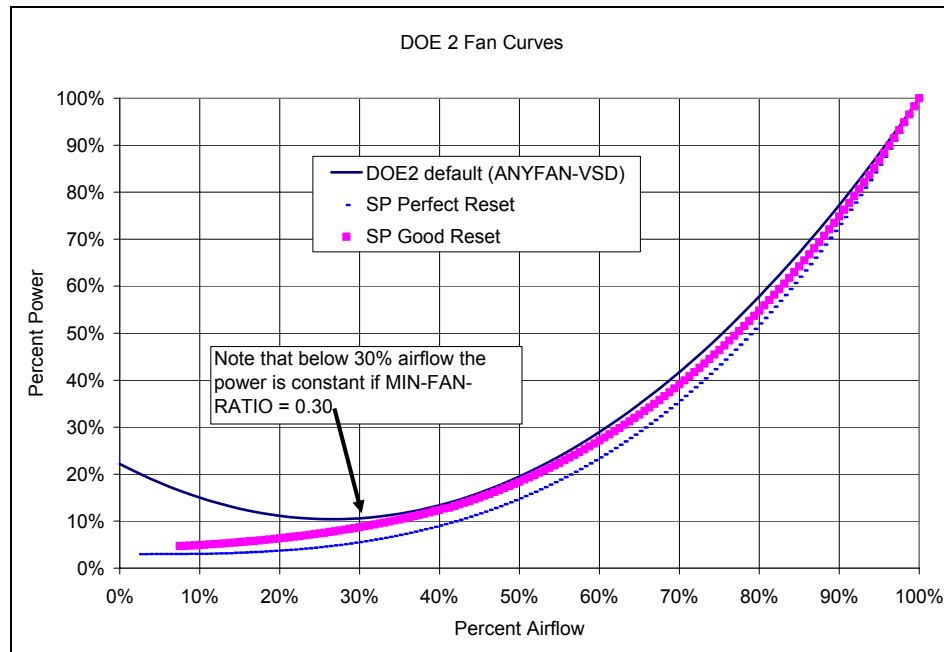

Figure 132. Fan Performance Curves for Simulation

VAV Box Sizing Results

Simulations were used to evaluate the energy impact of six different criteria or rules of thumb for box sizing ranging from 0.3" to 0.8" total pressure drop across the box. The simulation model described above was the baseline for analysis and then the model was modified to test sensitivity as follows:

- 8-bit analog-to-digital converter on airflow sensor.
- Aggressive load calculation assumptions.
- Highly conservative load calculation assumptions.
- Low load operating schedules.
- High load operating schedules.
- 24/7 fan operation.
- 50°F and 60°F supply air temperature.
- Supply pressure reset.
- Larger window area.
- Higher utility rate.
- Fixed zone minimum airflow fraction.
- High outdoor air load.

Figure 133 shows the incremental energy cost results for an average of all parametric runs, indicating that 0.5 inches provides the best performance. Descriptions and results for each scenario can be found in the Analysis Report.

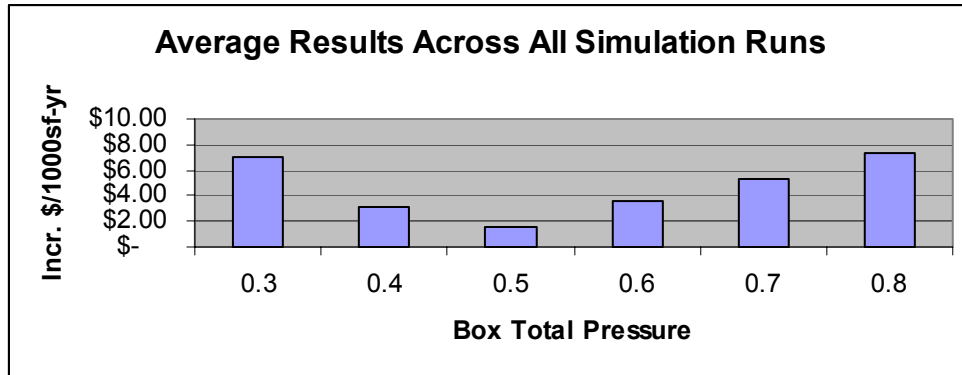

Figure 133. Average Results Across All Simulation Runs

Supply Air Temperature Control Results

The simulation model was used to compare several supply air temperature reset methods, and the results are listed in Table 30. The first two options, constant 55°F and SAT reset by warmest zone, are DOE-2 control options, and the results are available directly from eQuest. Results for the other five control options are combinations of two different simulations. In each of these five cases, the supply air temperature is reset by warmest zone up to the point the chiller turns on or the outdoor air temperature exceeds a fixed setpoint. At that point, the supply air temperature is reduced to the design setpoint, T-min (typically around 55°F).

1. Constant 55.
2. Reset by warmest zone. Supply air temperature is reset between 55°F and 65°F in order to meet loads in the warmest zone.
3. Switch to T-min when chiller runs. This scheme uses the same reset method as in Case 2, but switches to low SAT whenever the chiller is needed.
4. Similar to case 3, except that the SAT is reduced to its minimum setpoint whenever outdoor air temperature exceeds 60°F.
5. Same as 4 except with 65°F changeover point.
6. Same as 5 except with 70°F changeover point.
7. Same as 6 except with 75°F changeover point.

These results show Case 5 or 6 to provide the lowest electricity consumption as well as the lowest source energy consumption. Therefore, it appears that it is best to reset the supply air temperature upwards until the outdoor air temperature exceeds 65°F or 70°F, then reduce the supply air temperature to T-min in order to minimize fan energy and rely on the chiller for cooling.

Table 30. Supply Air Temperature Control Simulation Results

SAT Control Method	Cooling & Pumps kWh/ft ²	Fans kWh/ft ²	Total HVAC Elec.		Combined HVAC Source Energy kBtu/ft ²
			kWh/ft ²	Heating kBtu/ft ²	
San Francisco Climate					
1. Constant 55	2.43	0.38	2.81	5.23	33.9
2. Reset by zone demand	1.75	0.47	2.22	4.45	27.2
3. Switch to T-min when chiller runs	1.82	0.40	2.22	4.64	27.3
4. Switch to T-min when OAT > 60	1.88	0.40	2.28	4.58	27.9
5. Switch to T-min when OAT > 65	1.76	0.43	2.19	4.49	26.9
6. Switch to T-min when OAT > 70	1.75	0.45	2.20	4.46	27.0
7. Switch to T-min when OAT > 75	1.75	0.46	2.21	4.45	27.1
Sacramento Climate					
Constant 55	2.76	0.52	3.28	7.38	41.0
Reset by zone demand	2.30	0.63	2.93	6.55	36.5
Switch to T-min when chiller runs	2.33	0.52	2.85	6.80	36.0
Switch to T-min when OAT > 60	2.39	0.52	2.91	6.79	36.6
Switch to T-min when OAT > 65	2.30	0.54	2.84	6.60	35.7
Switch to T-min when OAT > 70	2.29	0.55	2.84	6.56	35.7
Switch to T-min when OAT > 75	2.29	0.57	2.86	6.55	35.9

Typical vs. Best Practice Performance

Significant fan and reheat energy savings are possible through the design strategies promoted in this Design Guide. The potential savings are illustrated in the graphs below which present simulation results; in this example the “Standard” case is a reasonably efficient code-complying system and the “Best” case includes a number of the improvements suggested in this guideline. The result of this simulation show that fan energy drops by 50% to 60%, and reheat energy reduces between 30% and 50%.

This example is by no means comprehensive. For example these savings do not include the impact of reducing duct pressure drop through careful design, the impact of properly designing 24/7 spaces and conference rooms, or the potential savings from demand based ventilation controls in high density occupancies. The assumptions in this example are presented in Appendix 6 – Simulation Model Description

Most of the savings are due to the efficient “turndown” capability of the best practices design and the fact that HVAC systems operate at partial load nearly all the time. The most important measures are careful sizing of VAV boxes, minimizing VAV box supply airflow setpoints, controlling VAV boxes using a “dual maximum” logic that allows lower airflows in the deadband mode, and supply air pressure reset control. Together these provide

substantial fan and reheat savings because typical systems operate many hours at minimum (yet higher than necessary) airflow. Appendix 6 provides more details about this comparison, and the importance of turndown capability is emphasized by examples of monitored airflow profiles in Appendix 3 and cooling load profiles in Appendix 4.

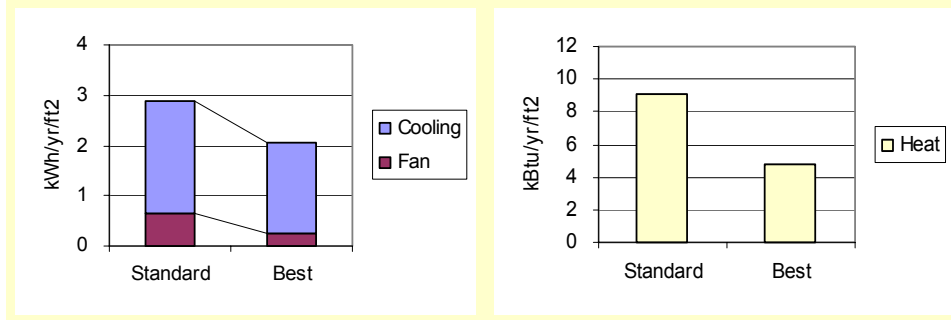

Figure 134. San Francisco

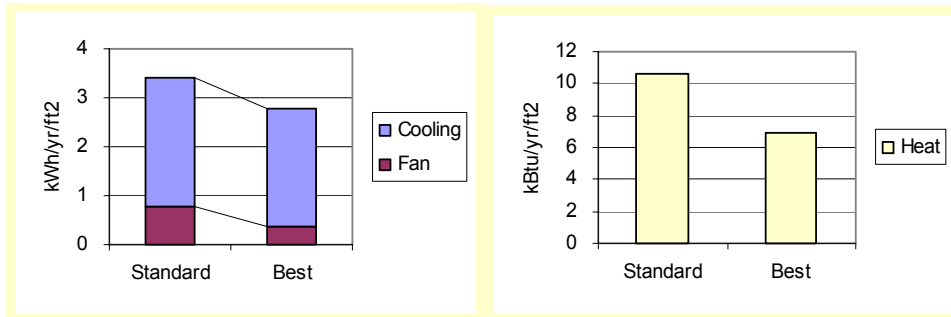

Figure 135. Sacramento

Appendix 7 – References

General

Commercial Building Survey Report. Pacific Gas and Electric Company, San Francisco CA. 1999. A useful resource for existing building stock characteristics in California.

The Control System Design Guide and Functional Testing Guide for Air Handling Systems. Available for no-cost download at <http://buildings.lbl.gov/hpcbs/FTG> . The control design guide portion is targeted at designers but will also be a useful support tool for commissioning providers. It includes information on the control design process, standard point list templates for various air handling system configurations, valve sizing and scheduling tools, damper sizing and scheduling tools, information on sensing technologies and application recommendations, and sample standard details that can be opened in AutoCAD® and used as starting points by designers.

The functional testing guide portion is targeted at commissioning providers but will also be useful support tool for designers. It includes information on testing basics as well as information on testing the air handling system at a component level and an integrated system level. Each chapter includes tables that outline the energy and resource benefits associated with testing that particular component, the purpose behind testing in the area that is the subject of the chapter, the instrumentation requirements, the time required, the acceptance criteria, and a listing of potential problems and cautions. Many chapters also contain a table that outlines design issues related to successfully commissioning the component that is the subject of the chapter. In many instances, this information is linked to additional information providing the theory behind the issues. The PG&E Commissioning Test Protocol library is fully embedded into the guide, allowing users to open and modify publicly available tests for their own use based on information in the guide and the requirements of their project. A calculation appendix illustrates the use of fundamental equations to evaluate energy savings or solve field problems including examples from projects where the techniques have been employed.

The guide also includes reference appendix listing numerous references that would be useful to those involved with the design, installation, commissioning, and operation of air handling systems and their related control and utility systems.

Energy Design Resources. <http://www.energydesignresources.com/>. This site has a number of design briefs covering a range of topics from simulation to chilled water plant design.

Kammerud, Ron, PhD, Ken Gillespie, and Mark Hydeman. Economic Uncertainties in Chilled Water System Design. June 1999. ASHRAE, Atlanta GA. SE-99-16-3. This paper explores the accuracy of simulation components like equipment model calibration and the accuracy of the load profile on the resulting cost-benefit analysis.

Controls

Hartman, Tom. "Improving VAV Zone Control." *ASHRAE Journal*. June 2003. Schemes for integration of zone controls including occupancy, lighting and temperature. Presents a challenge to existing practices for both comfort and energy performance.

Hartman, Tom. "Ultra Efficient Cooling with Demand-Based Control." *HPAC*. December 2001. Schemes for integration of zone controls including occupancy, lighting and temperature. Presents a challenge to existing practices for both comfort and energy performance.

Taylor, Steve. *ASHRAE Fundamentals of HVAC Control Systems Self-Directed Learning Course*. 2001. Atlanta GA. An excellent primer in HVAC control design.

The Iowa Energy Center website at www.DDC-Online.org provides a lot of useful information regarding DDC theory in general and a generic apples-to-apples comparison of the offerings of most of the major control vendors.

Supply Air Temperature

Bauman, F., T. Borgers, P. LaBerge, and A. Gadgil. "Cold Air Distribution in Office Buildings: Technology Assessment for California." *ASHRAE Transactions*, Vol. 99, Pt. 2, pp. 109-124, June 1992. Previously published by Center for Environmental Design Research, University of California, Berkeley, 61 pp.

Xiangyang Chen and Kazuyuki Kamimura. "Vote Method of Deciding Supply Air Temperature Setpoint for VAV System," *ASHRAE Transactions*.

Yu-Pei Ke and Stanley Mumma. "Optimized Supply Air Temperature in VAV Systems," *Energy*, Vol. 22, No. 6, 1997.

Night Flushing

Braun, James E., Ph.D., Montgomery, Kent W., Chaturvedi, Nitin. "Evaluating the Performance of Building Thermal Mass Control Strategies." *ASHRAE Journal of HVAC&R Research*, Vol. 7, No. 4. October 2001.

Braun, James E. *Load Control using Building Thermal Mass*.

Braun, James E. *Reducing Energy Costs and Peak Electrical Demand Through Optimal Control of Building Thermal Storage*.

Keeney, Kevin R., Braun, James E., Ph.D. *Application of Building Precooling to Reduce Peak Cooling Requirements*.

Load Calculations

Brown, Karl. "Setting Enhanced Performance Targets for a New University Campus: Benchmarks vs. Energy Standards as a Reference?" In *Proceedings of the 2002 ACEEE Summer Study of Energy Efficiency in Buildings*. 4:29-40. Washington, D.C.: American Council for an Energy-Efficient Economy. Presents an innovative procedure used to prevent oversizing of central plant and building services at the new UC Merced campus.

VAV Box Sizing

- Bauman, Fred, Charlie Huizenga, Tengfang Xu, and Takashi Akimoto. 1995. Thermal Comfort With A Variable Air Volume (VAV) System. Center for Environmental Design Research, University of California, Berkeley, California. Presents research on ADPI for diffusers over a range of flows.
- Fisk, W.J., D. Faulkner, D. Sullivan, and F.S. Bauman. "Air Change Effectiveness And Pollutant Removal Efficiency During Adverse Conditions." *Indoor Air*; 7:55-63. 1997. Denmark: Munksgaard.
- Persily A.K. and Dols W.S. "Field measurements of ventilation and ventilation effectiveness in an office/library building", *Indoor Air*, Vol 3, 1991.
- Persily A.K. "Assessing ventilation effectiveness in mechanically ventilated office buildings," International Symposium on Room Air Convection and Ventilation Effectiveness, Tokyo, 1992
- Offerman F.J, Int-Hout D. Ventilation effectiveness and ADPI measurements of a forced air heating system," *ASHRAE Transactions* 94(1), 1988. pp. 694-704.

Fans and Fan Systems

- AMCA Publication 200 Air Systems.*
- AMCA Publication 201 Fans and Systems.*
- AMCA Publication 202-88 Troubleshooting.*
- AMCA. 1990. *AMCA Publication 203-90, Field Performance Measurement of Fan Systems.* 0203X90A-S. The Air Movement and Control Association International, Inc. Arlington Heights, Illinois. This guide has many useful tidbits including field measurement protocols, data on belt performance and others.
- ASHRAE. *ANSI/ASHRAE Standard 51-1999 (ANSI/AMCA Standard 210-99), Laboratory Methods of Testing Fans for Aerodynamic Performance Rating.* 1999. Atlanta GA: American Society of Heating Refrigeration and Air-Conditioning Engineers. Details the methods of testing and rating fan performance. This includes the process used by manufacturers to extend limited data sets to a family of fans.
- ASHRAE. *ASHRAE Handbook of Fundamentals*, Chapter 32, Duct Design. Design guides for HVAC duct design and pressure loss calculations.
- ASHRAE. *ASHRAE Handbook of Air-Handling Equipment*, Chapter 18, Fans. Details on fan selection and performance.
- ASHRAE, *Duct Fitting Database CD*, 2002.
- Brandemuehl, Michael, Shauna Gable, Inger Anderesen. HVAC 2 Toolkit, A Toolkit for Secondary HVAC System Energy Calculations. ASHRAE, Atlanta GA. 1993. A compendium of component models for air-side systems.
- The Energy Design Resources briefs titled "Design Details", "Document Review", and "Field Review" discuss the resource and first cost savings associated with providing good detailing on HVAC contract documents. The first brief focuses on the details themselves. The second focuses on making sure the details are properly reflected on the contract documents. The third focuses on making sure

the installation reflects the requirements detailed on the contract documents. All are available for free download at www.energydesignresources.com. There are also numerous other design briefs on the EDR site, some of which are highly applicable to air handling system design including topics like Integrated Energy Design, Economizers, Drive Power, Building Simulation, and Underfloor Air Distribution.

- Hydeman, Mark, Jeff Stein. “A Fresh Look at Fans”. *HPAC*. May 2003. Presents a detailed evaluation of fan selection and control for a commercial office building.
- Hydeman, Mark, Jeff Stein. Development and Testing of a Component Based Fan System Model. ASHRAE, Atlanta GA. January 2004. Presents a new component based fan system model that can be used for simulations of airside system design. This includes details for modeling of motors, belts and VSDs.
- SMACNA HVAC Systems Duct Design*. 1990. Design guides for HVAC duct design and pressure loss calculations.
- Stein, Jeff, Mark Hydeman. Development and Testing of the Characteristic Curve Fan Model. ASHRAE, Atlanta GA. January 2004. Presents a new fan model that can be used for simulations of airside system design.
- Wang, Fulin, Harunori Yoshida, Masato Miyata. Total Energy Consumption Model of Fan Subsystem Suitable for Automated Continuous Building Commissioning. ASHRAE, Atlanta GA. January 2004. Presents a new component based fan system model that can be used for simulations of airside system design.

Filters

- Burroughs, H.E. Barney. “The Art and Science of Air Filtration in Health Care”. *HPAC*. October 1998.
- Burroughs, H.E. Barney. “Filtration: An Investment in IAQ”. *HPAC*. August 1997.
- Chimack, Michael J. and Dave Sellers. “Using Extended Surface Air Filters in Heating Ventilation and Air Conditioning Systems: Reducing Utility and Maintenance Costs while Benefiting the Environment.” Available from PECCI at <http://www.peci.org/papers/filters.pdf>
- NAFA Guide to Air Filtration*. 1996. (available from National Air Filtration Association website or ASHRAE website). This manual provides a complete source for information about air filtration; from the basic principles of filtration, and different types of filtration devices, to information about testing, specialized applications, and the role of filtration in Indoor Air Quality.

Outside Air Dampers

ASHRAE Guideline 16-2003. Selecting Outdoor, Return, and Relief Dampers for Air-Side Economizer Systems. An excellent and detailed reference for specification of dampers for air-side economizer systems.

The mixing and economizer section chapter in the Functional Testing Guide (see reference above under “General”) along with its supplemental information chapter contains a lot of information on dampers, economizers, and their controls. The control design guide contains information on damper sizing as well as a linked spreadsheet that provides the user with the framework for a damper schedule,

illustrates some typical sizing calculations, and includes the characteristic curves or opposed and parallel blade dampers.

CO₂ and DCV

Emmerich, Steven J. and Andrew K. Persily. “State-of-the-Art Review of CO₂ Demand Controlled Ventilation Technology and Application.” *NISTIR 6729*, March 2001. A thorough review of DCV technology and research.

Part 1 - Measure Analysis and Life-Cycle Cost – DRAFT 2005 California Building Energy Efficiency Standards. California Energy Commission, Sacramento CA. P400-02-011, April 11, 2002. Details on life-cycle cost analysis of demand ventilation controls for single zone systems.

Schell, M.B. and D. Int-Hout. “Demand Control Ventilation Using CO₂.” *ASHRAE Journal*. February 2001. An excellent primer on DCV control system design.

Schell, M.B. “Real Time Ventilation Control.” *HPAC*, April 2002.

Project Reports

The following reports, available at www.energy.ca.gov/research/index.html, or at www.newbuildings.org/pier were also produced during the research leading to development of this design guideline:

Integrated Energy Systems: Productivity & Building Science – PIER Program Final Report. This report contains the objectives, approach, results and outcomes for the six projects of this PIER program. A full summary of the *Integrated Design of Large HVAC Systems* project is included. Publication # P500-03-082

Large HVAC Building Survey Information (Attachment A-20 to Publication #P500-03-082), October 2003. This document contains the following three reports published by this PIER project: A Database of New CA Commercial Buildings Over 100,000 ft², the Summary of Site Screening Interview, and the Onsite Inspection Report for 21 Sites.

Large HVAC Field and Baseline Data (Attachment A-21 to Publication # P500-03-082), October 2003. This document contains the following three reports published by this PIER project: Field Data Collection (comprised of Site Survey Data Form, Site Survey Letter and Site Survey Schedule), Sensitivity Analysis and Solutions Report.

Large HVAC Energy Impact Report (Attachment A-22 to Publication # P500-03-082), October 2003. This report describes the estimated energy savings due to measures recommended in the guideline on both a per-building and statewide basis.